

TECO

Info



Congress floor of the newest Van Der Valk hotel in Veenendaal, the Netherlands, where one of the latest applications supplied by Tecomat Foxtrot was installed.

We are cranking up the speed

Introduction by the Company Director

Dear customers and partners!

I am pleased to say once again that 2014 was a very successful year for Teco, a. s., in many aspects. In annual comparison, the turnover grew by 22%, and exports by 40%. Long-term and systematic development of the Tecomat control systems, which are based on our own development results, began to bear fruits. The number of permanent customers is growing as well as the number of new market segments at home and abroad. We are pleased that the sales growth is largely due to rising export activities and not only thanks to sales to existing and traditional partners, but also thanks to the increasing number of new customers in other countries, such as Brazil and Portugal. High quality and progressiveness of our products have been positively evaluated not only by customers, but also by the professional community. This claim is further supported by the number of awards we have received so far.

Contents

■ We are cranking up the speed	1
■ TECO keeps receiving awards	2
■ TECO on various trade fairs	3
■ Training at home and abroad	4
■ Teco Point showroom network grows in Hungary	4
■ AAA rating for Teco, a. s.	4
■ Foreign partners and distributors	5
■ Foxtrot as a part of standard equipment designed for modular Huzzle houses	5
■ ID-31 and ID-32 displays	6
■ Solar radiation sensor on CIB bus	6
■ Foxtrot built-in design for OEM projects	7
■ Short pushbuttons for CIB bus in OBZOR and ABB designs	7
■ New air quality sensors	8
■ GT 175x – three new positioning modules	8
■ New picture rendering function for web-pages	9
■ Tecomat Foxtrot – a smart node in Smart Grid	10
■ Why is the Tecomat Foxtrot system so popular?	12
■ List of interesting references	16

In 2014, we have launched the latest hardware and software products, some of which may be found in this magazine. Many of these products significantly expand building automation options on terms of the world's most rapidly growing field, which has become an important part of our sales activities. For example. As far as the engineering field is concerned, we have developed new modules for multi-axis actuator control systems, which further expand the usability of Tecomat systems designed for particular industries. Tecomat Foxtrot system – as an OEM product, has become the standard electronic control system for many manufacturers of heat pumps, recuperation/recovery systems and other electrical heating appliances. In 2014, we have expanded the number of partners involved in this field and who appreciate the benefits that Foxtrot PLC

brings to them – that is an open, robust and flexible system with free programming options, a wide range of graphic control interfaces, remote access to diagnostic functions including remote control and on-line programming via of TecoRoute. Users have in their hands a tool, which may be used to develop their own know-how applicable to their specific fields. As far as the building control industry is concerned, this allowed companies to design various standardized solutions and developed them locally as well as abroad using the Tecomat Foxtrot platform. These solutions are ideal for mass deployment of simpler or more complex home automation systems utilized by large development projects as well as by private investors. The past year gave us many interesting reference thanks to the use of Tecomat systems in various fields. Some of them may be found at

our website or you may find some of them in this magazine. Although we are purposefully developing Tecomat systems as an open source system offering free programming and maximum flexibility, we are pleasantly surprised that in practical use, these systems may be efficiently used to control diverse and complex tasks. Therefore, in skilful hands of creative applicators our systems become very effective tools. At many trade fairs and exhibitions, both at home and abroad, we keep meeting our partners and those who are interested in advanced control electronics. We are also expanding standard user and turnkey training courses, which focus on specific issues and on a particular partner. These meetings give us the necessary feedback and strengthen our efforts to keep developing more sophisticated products.

Ing. Jiří Kovářik

Teco keeps receiving awards

Last year we have received a number of interesting awards, which further demonstrated the high quality of our products and services. The award ceremony called Golden Amper took place in Brno on 18/3/2014, at the just launched International Fair of electrical engineering, electronics, automation, communication, lighting and security systems called Amper 2014. We were pleased that a professional jury awarded our control system Tecomat Foxtrot with **the Honorable Certificate of Recognition** and that our system demonstrated once again its high quality and innovative features available not only to customers also to the professional community. A few months later Foxtrot scored at the Slovakian International Fair of electrical engineering, electronics, automation, lighting and telecommunication with a systems called ELO SYS by receiving and award for **the Most Successful Exhibit**.

Another interesting prize was the **2014 IT Product of the Year** award for our TecoRoute service. This competition event is organized every year by the Computerworld magazine. This award clearly shows the linkage between automation and IT industry, which is only getting closer. The award **HD EXCELLENT**, which was granted by the

HD World magazine to our Foxtrot system, proved that Foxtrot can beat many world's leading manufacturers of consumer electronics. At the 12th Annual National Award Ceremony organized by ČEEP, the 2013 Czech Energy-Efficient Project, Teco, a. s. has received the **prize of the Technological Agency** of the Czech Republic, for a project created by Mr. Roman Pospěch called Ekoenergie.org

– a system integrator that uses Foxtrot for sophisticated solutions utilizing a combination of photovoltaic (solar) energy sources and conventional energy sources.



TECO on various trade fairs

During the last year we have been presenting our products at a number of international and domestic trade fairs. Let us take a look at some of them.



Integrated Systems Europe – Netherlands



Energoprom – Ukraine



Elo Sys – Slovakia



For Energo



Light & Building – Germany



InfoTherma – Czech Republic



ForArch – Czech Republic



Amper – Czech Republic



Stavotech – Czech Republic



AquaTherm – Czech Republic



IBF – Czech Republic

Training at home and abroad

Customer training carried out at home or abroad is considered an essential cornerstone of a successful cooperation, because only sufficiently educated customers are able to fully utilize the entire potential of our systems. This is clearly seen thanks to our applications at work. We regularly perform several types of training starting with basic courses focusing on hardware/software, advanced training focusing on TC700 and Foxtrot systems and finally, specialized and advanced courses lasting for several days and focusing on programming in the Mosaic environment. Apart from these announced training courses, we also provide special training courses tailored to the actual requirements of our customers. To increase the efficiency and availability of our training courses to foreign customers,

we also offer on-line training handled via the Internet. This also includes regular and

individual training sessions and consultations.



Teco Point showroom network grows in Hungary

Hungary is a market where our control systems are successfully used in smart/intelligent homes and building automation systems. To support sales in Hungary, we are expanding a network of presentation showrooms called Teco Point, which aims to bring additional home automation options to end users who use Foxtrot, full technical installation support and assistance during subsequent operation and maintenance.

Thanks to joint marketing and logistics, this network is able to cover commercial and service requirements around the entire country, and will make home automation available to all types of customers. At present, Teco Points have been opened in in Budapest, Nyíregyháza, Veszprém and other Teco point is ready to be open in Győr.



New additions in the CFox, RFox and Foxtrot programming guide



As every year before the Amper Spring Fair, we are expanding our project guide, which serves as the basic documentation for all who use Tecomat

Foxtrot system for home and building automation. What is new in the guide this year? The chapter focusing on lighting systems offers examples of used power supply dimming systems designed for LEDs (both for current and voltage), and it also shows examples of larger LED dimming sets, light bulbs, and other sources (LED elements connected in parallel). There are also examples of commercial LED dimming systems (e.g. large LED panels). Another newly added chapter is dedicated to co-

nnexion and effective management of small photovoltaic power plants, focusing in particular, on own consumption and monitoring. The guide also contains examples demonstrating the connection of new electric meters and electric power analyzers including a wide range of current transformers. Also examples showing connection of new types of flow sensors (including drinking and utility water, and solar mixtures), and pressure sensors (water pressure sensors). Also examples focusing on hotel room control systems including door locks etc. are available.

And finally, a new chapter focusing on surge protection (SPD component application), new information and recommendations improving the reliability and durability of applications has been added.



Hodnocení nejvyšší důvěryhodnosti

AAA rating for Teco, a. s.

An independent company called Bisnode awarded Teco AAA certificate – the Highest Credibility Certificate. Thanks to this certificate our company belongs to an exclusive group of Czech companies that have been able to meet the strictest credibility and reliability criteria during the last ten years. This certificate is not only a positive evaluation of our activities we have done in the past, and which we value a lot, but it is also our commitment we must keep in the future.



Foreign partners and distributors

Recently, we have began cooperating (in addition to other customers), with two interesting foreign partners which chose our Tecomat Foxtrot system as their core product. One of those partners is a company called KERK Solutions in Brazil, which has been dealing with home automation systems available at the Brazilian market for 25 years with a particular focus on higher clientele. During its long existence at the Brazilian market, the company has been experimenting with a wide range of systems, but since the last year, the company began deploying and distributing our system Tecomat Foxtrot only. What led them to us? According to the owner of the company Mr. Eduardo Albuquerque, it is the great flexibility and comprehensiveness of the Foxtrot, which allows them to apply the system to a complex applications. Also thanks to the open source feature of the system, which allows them to integrate additional technologies into their solutions and according to their needs, and regardless of the manufacturer. In practice, this allows them to use, for example, integrated IR modules manufactured by Global Cache, through which Foxtrot controls air conditioning units in each room where Foxtrot is used. Remember, Brazil is a very hot country, and as in our climate we pay a great attention to heating systems, in Brazil, on the contrary, we need to pay attention to cooling, which may save a lot of energy if managed appropriately, while still providing a pleasant climate.

As an important feature Mr. Albuquerque sees the option to apply their own design and use their own control structures, which they perfected by the way, and created their own applications for Apple devices used by 99% of their customers.

Another interesting foreign partner is InfraSecur company in Portugal, which is also engaged in building automation systems. Outside of Portugal the company is present in Angola and Mozambique, where it operates its own branches. In terms of project types, the company has been deploying automation systems for medium and large projects – hotels, hospitals, commercial and industrial buildings, etc.

The company sees our Foxtrot system attractive thanks to its flexibility, which allows integration of virtually anything, and also thanks to the reasonable price of the system. Also the robustness of the system, proven over many years and in many countries in different climatic conditions plays a role. Thanks to InfraSecur, the first installations of Foxtrot systems have already been completed in Portugal. Let us mention for example the My Story Hotel in Lisbon or the elementary school building in Alverca. Both our new partners reported a great level of satisfaction when deploying Foxtrot. We are very pleased to hear that and wish to both our partners many successful projects using our products.



Hotel My Story in Lisbon, Portuga, is controlled by system Tecomat Foxtrot. More about this reference you can find in this magazine or at our website.

Foxtrot as a part of standard equipment designed for modular Huzzle houses

Rikostav Container Company, s. r. o. introduced an entirely new product to the Czech and Slovak market that will be used in modular building systems. This product represents three-room and four-room family houses named Huzzle. Their main advantage is the speed and simplicity of construction, which is possible thanks to the preparation of the entire house done in the factory and then

quickly assembled on-site. The advantage you get from such standardization is a low investment and operating costs while utilizing modern and high-quality materials and technologies. Each standard Huzzle house is equipped with infrared floor heating system or intelligent electrical system Domotron, which is another type of solution for mass deployment of home automation systems

built on Tecomat Foxtrot system. Revolutionary idea introduced by the Huzzle project, is a full integration into smart homes classified as standard housing.

More information at www.huzzle.sk site.

Showroom address:

Parkovisko nábytkového domu Sconto, Nová 10, 917 01 Trnava,

Tour booking: +421 908 317 700.



ID-31 and ID-32 displays

Another innovation introduced to the market in the last year are small 4" color touch screens. They are available in two different designs and models; one is labeled ID-31, designed to be mounted on a wall and into a regular wall installation box. The other one is called ID-32 and it is designed to be built into a cabinet or control panel of a given equipment or anywhere else where rear access for installation is available. Both versions are supplied in standard four colours: anthracite black, metallic dark gray, metallic aluminium and matte white. These colours were selected as they matched the most frequently used colours of wall switches and sockets produced by most manufacturers. However, you may order virtually any colour including glossy finish or coloured chrome.



A sample of available customized chrome surfaces

being able to deal with lines, polylines, polygons and graphs using dynamically varying shapes controlled by data from the program, is able to return back to Foxtrot the actual position, colour of the pressed screen spot as well as the length of the press. This opens new possibilities for the use of impressive "sliders", "colour-pickers" and buttons with auto repeat features.

The touch screen area on the wall-mounted design is modern and capacitive as the majority of the population is accustomed to due to the use of tablets and smart phones. On the other hand, the built-in ID-32 model is intended rather for industrial devices, which use the resistive principle and which requires the user to exert a certain pressing force in order to avoid unwanted pressing and thus making sure that the control was pressed intentionally.

As for connectivity, the basic communication channel is the Ethernet. The connector is located behind the spot where the display is to be installed into an installation box which will cover the cables. This cable may also be used to power the display through unused pairs of UTP cable using a suitable 24V injector, similarly as with WiFi routers. However, on the other connector we may also bring a separate 24V DC power supply. Furthermore, you will also find terminals labelled CIB and TCL on this connector. These buses serve as a reserve and will be used for subsequent firmware upgrades.

Currently, TCL terminals utilize a serial port for alternative communication with Foxtrot. This due to the fact that if you want to keep the Ethernet port at the Central office/headquarters. For example, if you need to connect to the Internet. The rear USB port is ready for WiFi adapter. On the rear, you will find an opening and behind it a small speaker ready for future sound effects, for example to confirm and accept pressing on the screen etc. In the lower section, you will find a micro USB connector. Again, it serves as future and available reserve. Now you can use the connector for a basic power supply from any USB port on your computer, AC charger or from a backup battery pack available today for mobile phones.



Interior displays ID - 31 are available in anthracite black, aluminium, white and dark grey colour shades

Both version use the new Sitara ARM processor series, which together with large RAM and Flash memory provide the display with plenty of power and therefore, also with new possibilities in comparison with the existing display ID-18/28. These displays and the new series use a built-in webpage interpreter from Foxtrot. As a new feature we added a "canvas" interpretation function or rather "drawing canvas". This new object will allow us to create other interactive objects in our own web pages using PLC program and elementary graphic functions. As it is written in another part of this newsletter, this new object, in addition to



Front view of the ID-32 built-in model



Rear and bottom view of the wall-mounted ID-31 version with mounting holes and connectors.

Solar radiation sensor on CIB bus

For applications where Foxtrot system manages more complex energy sources, together with photovoltaic equipment, a new pair of modules with sensors made of monocrystalline silicon solar cell have been designed. These modules are primarily utilized as calibrated reference data to check the function of photovoltaic power plants (FVE/PPP). The measuring range is from 0 to 1500 W/m². The actual sensor is delivered under model name S-SI-011 in a plastic box with IP65 protection class for outdoor use. It includes integrated temperature sensor for thermal compensation.

Both sensors may be connected via a cable to any modules on the CIB – bus, typically to C-IT-0200I, C-HM-xxxxM, R-HM-xxxxM, or C-AM-0600I.

The C-IT-0200-SI model is in a box made of UV-resistant polycarbonate plastic and it is integrated with a CIB converter module. To calculate the intensity (W/m²) the Mosaic function is used and you need to enter the calibration constant for the specific sensor. This constant is available on the label located on the inner side of the lid. You need to write it down before installing the sensor.



Built-in Foxtrot system designed for OEM projects

Last year we have introduced a completely new built-in version of Foxtrot system designed for manufacturers of heating equipment, heat pumps, automatic boilers for solid fuels, HVAC units with recuperation feature, cogeneration (CHP) units and other equipment and devices. The new built-in Foxtrot is labelled as CP-1970 and it is a simplified open module without covers and it was designed to be installed in places where the manufacturer installs other electrical equipment, which solves the "cover issue". The new Foxtrot is a "single-board" system and utilizes the perimeter for connectors as much as possible. The entire system is ready for modifications to accommodate specific combinations of inputs and outputs for a specific manufacturer. This type of Foxtrot system is intended for manufacturers, mainly because it cannot be delivered as a single unit as the regular Foxtrot system, but minimal order quantity is necessary. As far as inputs are concerned, Foxtrot CP-1970 is ready to accommodate combinations, which will allow direct connections to

- water, air or combustion temperature
- water, air pressure sensors
- water flow sensors, both impulse and vortex sensors
- humidity sensors
- CO₂ concentration sensors
- electrical energy measurement devices
- temperature measurements – calorimeter
- Mass Remote Control status signalling
- contacts and other binary signals

As far as the output side is concerned, it is possible to allow for binary command combinations from several relay types based on electrical current load and contact connections, as well as outputs which will allow direct control of:

- circulator pump EC motor RPM
- compressor RPM

- DC motors RPM
- stepper motor RPM
- water or gas valve positions
- actuators and flaps position (water, air, gas)
- electronic expansion valve position

It is possible to select either 230VAC supply voltage with built-in switching power supply or 24V DC. It is also possible to select the best combination of communication interfaces. Leaving out Ethernet interface is an extreme approach. By doing so, the user loses one of the biggest advantages of the new era and that is a direct connection to the Internet, which may be used for remote administration, modifications or upgrades done directly in Mosaic, as well as for comfortable and convenient firmware upgrades using the Firmware Updater.

For manufacturers, the new Foxtrot is the fastest way how to put their products into the so-called Internet of things (IoT). As far as hardware is concerned, this built-in Foxtrot is fully compatible with other Foxtrot systems. Thanks to the integrated high-speed of T2L2 bus, the system may be extended using any modules from the kit designed for this bus. These include both input and output modules, as well as many communication modules with serial ports (RS-232, RS-485, CAN including specialized OpenTherm and Belimo) and selected operator panels ID-14, ID-17.

Master bus called CIB Common Installation Bus® is very important because it allows connection of many interior components designed by all leading switch and socket manufacturers.

Today, combined humidity sensors, CO₂, temperature sensors, motion detectors and interior displays are on the CIB bus allowing you to set

required values and other parameters comfortably. Built-in Foxtrot may also be combined with the new 4 "touch screen ID-31, which is connected via the Ethernet port. The display interprets internal websites and it is therefore, the simplest full graphic and fully programmable Interactive Panel of the given device. It is also available as the built-in version labelled as the ID-32 model. This model may even be connected to the centre/headquarters via its serial port, which allows you to "save" the Ethernet port on the base module and which you may use for Internet connection. For easier application, we have designed alphanumeric OLED display with a mechanical button matrix allowing you to mount it on the front of the input/output unit CP-1970's. We are ready to discuss your intentions and individual control solutions based on our Foxtrot system. Become a member of the ever-expanding community of producers, which put their trust in a well-established and continuously developing PLC standard represented by Tecomat Foxtrot®.



Short pushbuttons for CIB bus in OBZOR and ABB designs

At the 2014 ForArch exhibition, we have introduced our expanded portfolio of short pushbuttons which are compatible with Common Installation Bus®. This portfolio was added with a complete range of many domestic switch and socket manufacturers. OBZOR company introduced single and double switches Elegant, and Variant and the latest line called Decente. ABB offered its newest design Levit and also Alpha Neo, Future Linear, Solo, Neo and NeoTech, Time and Element, and the old but still very popular Tango. Designs of all series are unified thanks to the use of original attachment of switch buttons in frames supplied by manufacturers, so their fixation and guidance when pressing the switch is guaranteed. Two-colour LED indicator is installed under each switch flap, which may be controlled by the program available in the basic Foxtrot module. Each switch is also equipped with a built-in temperature sensor.

There are also terminals allowing you to connect other two external temperature sensors, or another two contacts. All these models are also equipped with other devices: thermostats, RFID card readers, PIR motion sensors, IR and

remote control transmitters and newly also with air quality sensors in combination with temperature, humidity and CO₂ concentration sensors.



New air quality sensors

CO₂, humidity and temperature sensors on CIB bus in wall switch design

For the interiors, where the overall design and small detail matter and where the interior air quality including ventilation are taken seriously, we have designed new modules which measure the concentration of carbon dioxide, relative humidity and temperature. These modules are integrated into a single wall size switch module. Last year Foxtrot system significantly expanded the range of interior module designs including all major domestic and foreign suppliers of switches and sockets. We are happy to announce that the line of these new measurement modules are now available. Due to the availability of dozens of designs and various colour combinations offered by many manufacturers, the number of variations and series rises exponentially. It is clear that these are mainly custom-made products with longer delivery time – up to 4 weeks. These modules are available in combinations with these sensors:

- Humidity + Temperature labelled as C-RQ-0600R-RHT
- CO₂ + Temperature labelled as C-RQ-0600R-CT
- CO₂ + Temperature + Humidity labelled as C-RQ-0600R-CHT

When ordering you need to specify the design type and frame or possibly middle frame colours using the ordering numbers of the respective manufacturer.



- CO₂ – labeled as C-RQ-0600R-CO₂

GT 175x – three new positioning modules for engineering applications

At the end of last year, we have added our line of expansion modules PLC Tecomat Foxtrot with modules able to control multi-axis position of machines. Especially metal turning machines. These traditionally use the Tecomat abbreviation “GT” and are supplied in three variants:

- **TXN 117 51 – GT-1751**
– 1 axis position control.
- **TXN 117 52 – GT-1752**
– 2 axes position control.
- **TXN 117 53 – GT-1753**
– 4 axes position control.

Each axis has its own control loop with PID regulator. The output is an analogue signal ± 10V DC which controls the actuator. Feedback signal is closed via a sensor controlling the actual position (proximity sensor), which may be an incremental sensor – encoder –

or position sensor with SSI communication interface.

Each axis is supported with binary at 24V DC digital inputs used to connect the startup switch into the reference frame of the other two limiting switches, and a probe switch, the so-called touch measurement. There is also a relay output which is used to control brake actuator.

Individual axes can operate either as completely independent axes or in correlation with different types of interpolation. The 4-axis

model allows 3 axis to work in linear harmonious interpolation.

For circular interpolation, you may use any two axes with interpolation in one of the three planes. It is also possible to select dependence on revolutions, the so-called “minute shifts” or shifts dependent on the fourth axis including threading a lift. Different types of axis dependency may be combined in one module. Programming supports a library of functional blocks MotionControlLib pursuant to IEC 61 131-3.



Four D-Sub15 connectors at the bottom are used to connect position sensors. Two D-SUB25 connectors use outputs ± 10V DC to control the actuator.



One of the first deployments of the GT-1753 positioning module utilized by KASKO company in Prague on automatic grinder BD 80 NC, which is used to grind cylindrical and conical holes in large series production.



Module GT-1753 used to control 4 axes is designed in 12 modular box and attached to a DIN rail. The threaded green connector is used to connect the power supply and TCL2 system bus.

Canvas in WebMaker - new dynamic picture rendering function for web pages

Highly valued property of Tecomat systems is the option to create a user interface in the form of web pages. For a long time you were able to improve the look of your website with dynamic elements using double or multi state images, but it was always a step-change using a different image or graphic element and never a continuous re-shaping or colour value change with a slider bar or displaying a line diagram instead of a column, popup menus, etc. But options offered by the already-mentioned CanvasLib library in Mosaic environment will allow you to meet these task easily. The library is supplied as part of the Mosaic environment starting with version 2014.5 and up, and it is supported by all central Foxtrot units and by central units CP-7004 and CP-7007 belonging to the TC700 series starting with firmware version 8.8

The library contains functions and functional blocks which allow the user program to render graphics in the PLC program that will be displayed on a website or on new generation operator panels ID-31 and ID-32. To a limited extent – based on the performance of the hardware and based on older graphic library, these graphics may also be displayed on older panels ID-18 or ID-28.

Canvas refers to a drawing canvas, and it is an element, which may be inserted into a new website while creating the design in

WebMaker. The drawing principle is based on storing commands and their parameters in a special buffer which is transferred to the display device (operator panel ID-3 or web browser), after the drawing is completed. The completed image is only drawn up (rendered) using these commands in the display device. Depending on the complexity of the graphics the PLC cycle time may be extended. It is therefore recommended to call drawing functions only when you need to change the image. Cyclic drawing/rendering of the same graphic/image over and over puts unnecessary load on the PLC and on the transmission channel carrying data to the display device. If you stop calling graphic functions, the buffer remembers the last rendered image, which is transmitted to the display device as needed. If you want to use CanvasLib library functions in the PLC application program, you must first add this library in the project. The drawing canvas element is inserted into the webpage and linked with TCanvasData buffer type, where we direct all graphic operations. After completion the drawing is automatically transferred to the display device. Depending on the complexity of the displayed graphics, also the demand on the size of the graphic buffer grows. Buffers may be defined in various sizes in order to use PLC memory optimally. However, the total sum of buffer

sizes must not exceed 8 kB per one website. That means that we can place several drawing canvases on one webpage.

Nonetheless, library functions do not only allow you to draw the desired shapes on a web page. They also allow you to copy the mouse cursor position, save coordinates of a finger touch on the screen or to copy the colour present at the click or touch spot. Therefore, you may use the webpage to actively manage the entire system, for example, to select RGB colour for the lighting using the colour palette and to control the brightness by sliding your finger across the touch screen.

You may use more than 50 functions available in the library for your drawing. These are divided into several categories. Each drawing must be initiated by calling the GC_Begin function and must end by calling the GC_End function. The GC_Begin resets the buffer and unlocks it for recording, and the GC_End function locks the buffer and allows rendering.

Drawing begins by setting parameters of the workspace, by defining coordinates, specifying the background colour, lines and fonts, styles or font styles. To set characteristics and appearance of drawing elements we use predefined colour constants, font styles, and line types, but also the necessary selection scale etc. To enter multiple proper-

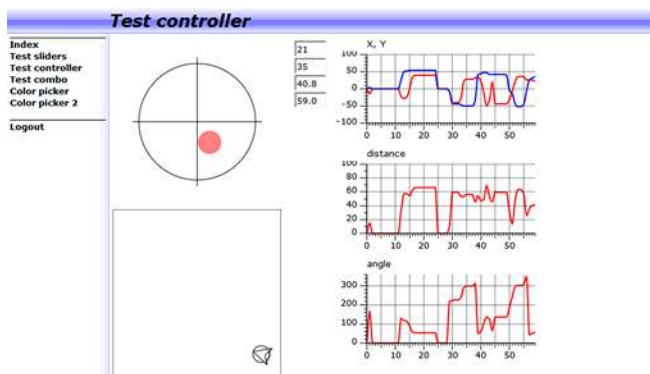

Demonstration of position control using a virtual joystick by dragging the cursor using a circular controller.

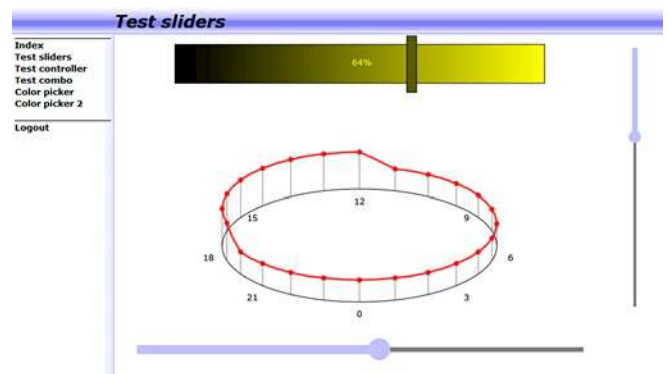

Demonstration of the use of a slider to rotate the graph and display values in a circular chart.

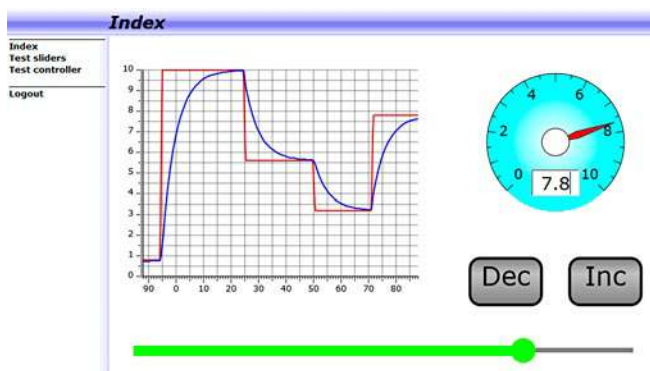

Display of a line chart and an example of a device using a slider to set added value.

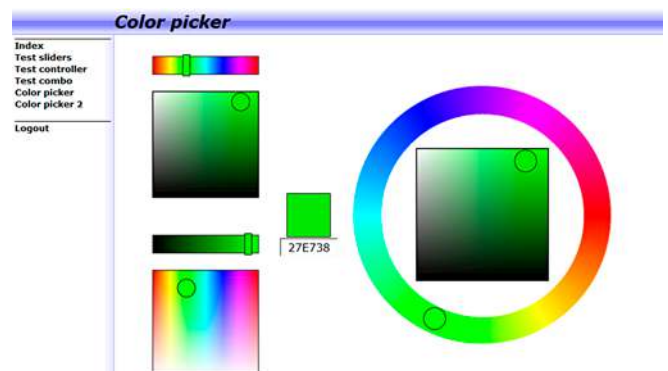

Various elements used to select the desired colour.

ties simultaneously, we use the plus sign (e.g. GTEXT_STYLE_BOLD + GTEXT_STYLE_ITALIC). Another group of functions include functions used to control the movement of the drawing pen. The actual drawing is done using functions allowing rendering of different elementary graphical shapes – lines, arcs, circles, rectangles or polygons. You may also place on your canvas completed images associated with the workspace/drawing space. Another issue is a graph displaying. Enhancements of graphics on a website using dynamic controls is certainly a useful option, but let us face it, most users call for a feature that allows convenient display of line or bar graphs. CanvasLib allows that. Functions used to render line or column diagrams/graphs from a set of values were added with functions allowing you to display a linear scale. Circular scale lets you draw various virtual measuring instruments, which may also be coloured. Input parameters of the above functions allow the user to modify the appearance of graphs and instruments so they look the same as in SCADA/HMI, and the user may do so by setting it at the website. The remaining functions allow you to define macros for repeating blocks of graphic operations, because using them saves space in the graphic buffer, and to work with them. You may use two separate repositories to store the angle and the position of the pen. These basic features specified above give you a large range of possibilities allowing you to draw any custom graphics and to create

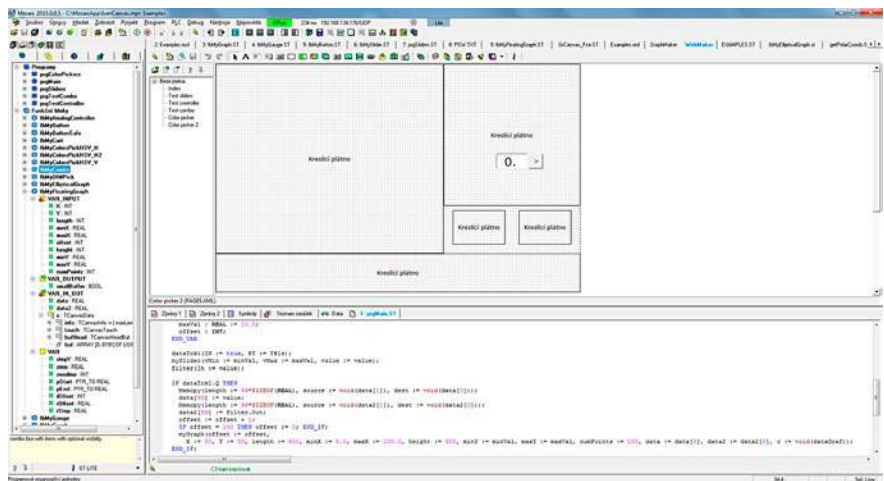

Page editor with graph rendering program opened in Mosaic development software.

your own specific web design. Users will certainly welcome predefined function blocks, which will allow you to easily create a variety of graphs, instruments, control and display elements, to work with colour palettes without the need to create everything through the use of basic functions. You may already use examples posted on our site www.tecomat.com, where these functional blocks have been prepared for you. Unlike libraries, examples of functional blocks also include source codes, so anyone who sees it fit, may modify them according to their own needs and then be able to use the library as soon as possible.

The example includes e.g. a functional block that handles a pushbutton that remains pressed down while you holding a mouse button, thus allowing you to define short and long press performed at the website, a functional block of a slider for smooth adjustment of values, a control element called "combo box" used to select the desired function, functional blocks and several different colour pallets used to chose colours, functional block used to display measuring devices with a circular scale, and functional blocks used to display graphic curve of one or two variables. Last is given a functional block called Analog Controller, which serves as a virtual joystick.

Tecomat Foxtrot – a smart node in a Smart Grid

This term outlines the technical direction that is occurring in the development of electric distribution networks, which were originally built to transfer electricity, and which are operated by managing multiple predefined sources based on the actual consumption drawn by thousands and millions of connection points. These grids must be added with network traffic information in real time, which allows the operator/provider to constantly maintain a balance between the consumption and production of electricity. All this in a situation when the number of renewable energy sources contributing to the grid increases, and therefore, some power drawing connection points may suddenly become power sources. The output of such sources depend on the immediate level of sunlight or wind where the given source is located. This applies mostly to photovoltaic or wind power units, regardless if these units are in the field, on the roof of a family house or on the top of a commercial building. The meaning of the term Smart Grid is often reduced down to Smart Metering, which refers to collection of data from smart electrometers able to provide information about the consumption curve drawn by a particular place. Yes, without measurements there is no control. But to manage the system in real time you need more information. Especially, you need an estimate of future consumption or pro-

duction levels at the particular location, as well as information and commands, which enable you to turn the system ON or OFF remotely. The article focuses on the Foxtrot system, its measurement and control options, remote communications and about being ready to become an active node of the Smart Grid at any time.

A tool in the hand of a company energy manager or electric power trader

We are used to the fact that electricity in the power grid is always available and when you need it. But to take full advantage of RES it is necessary to learn to adapt immediate power production to immediate consumption. If there is a surplus of energy at a given time it is necessary to find customers who can use the surplus. That is customers who postpone their consumptions and are ready just for this situation. The Smart Grid network should therefore exchange information about who and where energy surplus exists and who and where is ready to turn appliances ON and use the energy. Finally, a command must be initiated that will turn the appliances ON. This is the technical part. The second part is economic. If energy surplus exists, it means the supply exceeds the demand and the price falls and vice versa. The immediate price of energy in the power



Clear view of energy use and transfers may be displayed on a home tablet as well as on a company energy department monitoring device.

grid changes at any instant. An ordinary consumer is not aware of this fact. Customer may only have information whether, at a given moment, he uses a low or high tariff. However, even based on this information the consumer may adapt his energy consumption habits. In family homes this may postpone the time when the dishwasher, washing machine or dryer is turned ON, but companies have many options to move or postpone power-drawing activities. These options vary from company to company. On the other hand, an energy trader knows that energy price changes every hour and that it depends on the supply and demand levels at the energy exchange market and that these

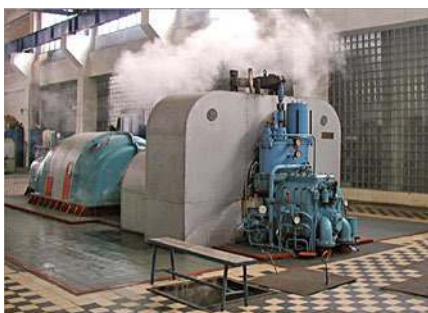

The corporate energy system controlled by Tecomat may also include a steam-powered turbine (Sugar processing plant in Rimavská Sobota)

prices fluctuate every day and hour. To fine the optimum balance, the trader needs information about energy production, consumption levels and accumulation of all his customers. However, historical data are not enough. The trader needs information about future development of consumption, production and accumulation of customers at each location and data about upcoming and long-term plans of each location involved in the grid. This applies both to households and large customers and producers. Accumulation and deferred consumption of electric power or economic influencing of consumers is nothing new. Household boilers charged with cheaper "night power", now known as the "low tariff", regulation or the 1/4 hour maximum – failure to observe this maximum is sanctioned by higher price, are technical and economic methods which were used to maintain balance between consumption and production of electric power since the beginning of the power industry. This is possible thanks to technical devices that existed even before the era of computers, the Internet and mobile networks. They still function today and they can function even without them – Mass Remote Control or timers – used even earlier. We also see that in addition to technical devices allowing you to turn boiler ON/OFF, even today and without

using the Smart Grid, we work with electric power prices which vary over time.

If you make a list of all variables relevant to a supply point in the grid and which are necessary and useful both for consumers and suppliers to maintain rational and efficient behaviour, you will get rather high volume of data, which needs to be transmitted continuously and in both directions (bidirectional transfer). However, the terms "supply point" and "bidirectional communication" are not accurate. Let us talk about a node in the power grid, which can consume, accumulate (store) and even supply power to the grid, and about data communications that are useful not only for the supplier – the electric power trader, but which may also be used by a neighbouring node through a distribution substation.

Let us focus on nodes that have been acting as typical consumers and divide them into commercial enterprises where sustainable management of energy and costs is handled by the company energy technician, and into residential consumers – usually households, where the energy bills are handled (if at all) only by the family member who actually pays for these bills once a year – when the physical bill arrives. Although even in this area there is a significant and growing percentage of investors who care about cost and balancing of technical resources, accumulation, and energy consumption, and invest into technical equipment, or even change their behaviour in order to use energy more efficiently and to reduce costs. Some of them even strive to become self-sufficient.

The above introduction was given in order to give you a better idea what and why Smart-Grid should be able to do, and to suggest that virtually all nodes will have to be able to solve the same technical problems.

Whether this concerns business with energy management departments or houses and households, the only difference between them lies in the used technologies, types, designs and combinations of resources, storage devices and appliances. And of course,

in the size of transferred powers in one or other direction and in the costs and revenues created by these transfers. Let us continue with a brief description of the Tecomat Foxtrot system, its functions, use and installation issues which depend on the system to become a Smart Grid network node.

Foxtrot is the latest of the Tecomat systems, which were and still are intended for industrial control applications of machines and production lines, processes, transport and buildings. The system is ready to work 24 hours, 365 days a year. It features inputs and outputs that may be used for measurement and control of any variables, any device or process. It features a massive local storage in the order of gigabytes allowing long-term recordings and archiving which are available upon request at any time. It is also equipped with a variety of communication channels – serial and Ethernet ports, which allows you to connect secondary or subordinate devices, but it may also be connect to a superior system or directly to LAN/WAN, and especially to the Internet. The system is able to communicate on these channels in parallel with various protocols and transfer data from one protocol to another. It also uses http protocol – a protocol used by web browsers, and it is equipped with an implemented web server. In addition to a huge memory, where user programmable website are stored, the system behaves as a fully-equipped web server which uses the Internet and private networks (VPN). Thanks to http protocol the system is also able to communicate with other devices and servers in the network, including databases servers. XML and JSON and other formats are used to exchange data. These protocols may be used for example, to detect local weather forecasts, or to check the energy prices on the Internet – today available in tables published on the Internet for example, by PRE. It also communicates with other network protocols and uses SNTP protocol to synchronize its internal clock with Internet server time, so each recorded event may be marked with an absolute timestamp with a great precision. Another used protocol is SMTP. That means Foxtrot is ready to send and receive email messages. Communication modules used by the Foxtrot system also include modems used to connect to operator mobile networks. Thanks to transparent connection to the Internet or to the ability to transfer information via SMS you may send information from virtually anywhere. Measurements of pulse water meters, gas and electricity is standard. However, Foxtrot also communicates with smarter system – thanks to the M-Bus protocol using both two-wire bus and a wireless protocol called Wireless M-Bus. Other system components include RFox series input and output modules, which communicate in both directions wirelessly using 868 MHz bandwidth. These modules enhance and extend the flexibility of the system because it allows you to connect and control devices that cannot use cables. As far as the energy management sector is concerned, both domestic and commercial, the fact that Foxtrot is ready to communicate directly with frequency inverters produced by various manufacturers, or even with battery

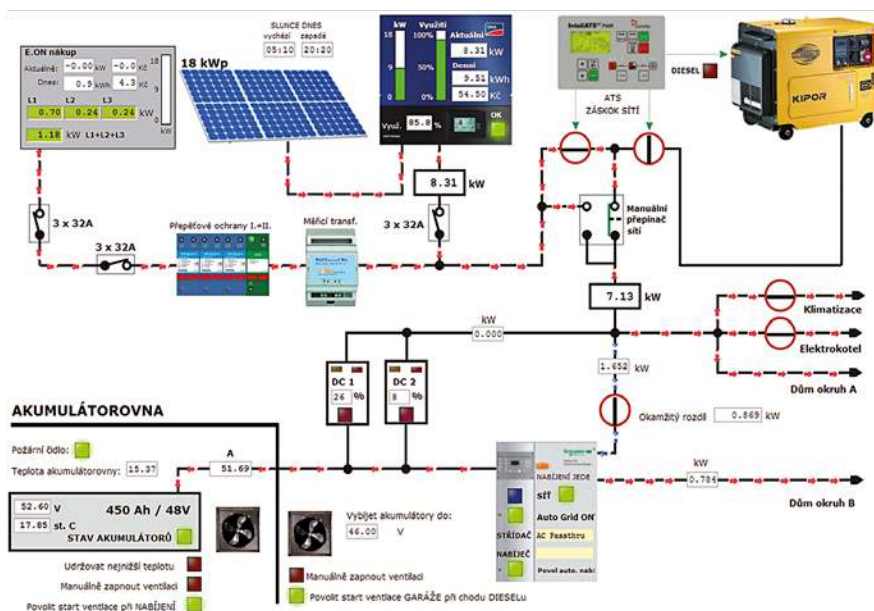

Foxtrot website showing a diagram of a real energy system in a family house with current values of selected variables (according to Flextron documents)



In BIOENERGO COMPLEX in Kolin, Czech Republic, is used system Foxtrot for control of biomass combustion boiler for 6MW generator.

chargers and with hybrid photovoltaic inverters, is very important.

A key part of the Foxtrot system is integrated two-wire installation bus called CIB – Common Installation Bus® that opens a door to home automation systems. But not only that. Modules with CIB bus which belong to the CFox line, may be used in any industry or for telemetric monitoring. The bus offers free topology with open branching without the need to end each branch. The same two cables/wires are used to carry both data and power for all modules on the bus. Foxtrot system is ready to be connected to KNX installations, where the system may perform all central function and play the role of a communication server communicating with own web site and allowing direct connection to the Internet. Foxtrot system is integrated into the Internet far deeper than other similar systems. Especially long-term administration and service is supported by Updater Firmware, which will find Foxtrot anywhere on the Internet, will scan its configuration including the firmware version of each module, and will com-

pare them with current versions located on a company server, and will offer options and will automatically update firmware on user-confirmed modules.

Another important service which will be available in the future especially in the Smart Grid, is a communication service TecoRoute that will allow connection of any Foxtrot around the world and without the need to assign a public IP address. In addition to the cost related to the assignment of public IP address which, by the way, will be all used up very soon, it makes addressing and address transfers on all routers much easier. The service is also immune against exchanges and readjustments of routers or even against Internet providers. There is no need for any additional HW to create VPN and the system within LAN is not visible from the outside (on the Internet), which makes life of IT administrators easier. The service is used for a remote programming done in Mosaic, but mostly for any web browser, either on PC or on mobile phones and tablets.

Using Foxtrot to manage energies

Industry oriented companies use Foxtrot systems not only to control machines and technologies but also to control the 1/4 hour maximum and power factor, and often for comprehensive data collection from meters. Integrating Foxtrot into production lines and machines also allows them to be integrated into the company energy sector in terms of electric power consumption and intelligent ON/OFF switching.

Foxtrot system are often used for so-called measurements and regulations – that is, where the consumption drawn by heating, cooling and ventilation systems is regulated. This mainly applies to commercial and office buildings. Even here we see the potential of Foxtrot systems for all these installations and the option to be integrated into the Smart Grid together with all secondary appliances and energy storage devices.

Foxtrot and Tecomat systems are generally supplied to enable control of energy infrastructure used by the Czech Railways and transportation companies. Here our systems acquired the ability to communicate with protocols according to IEC 60870-5-104. These protocols are able to communicate with superior energy systems used by power supply companies.

Expansion of Foxtrot systems into home automation is a significant milestone. Especially here in private households we see the first attempts to use sophisticated combinations between consumption, accumulation (storage) and energy production from renewable resources applied to your own premises and for own money.

Conclusion

Foxtrot may be used in all the above applications for aggregation of data describing consumptions, productions and accumulation of energy, their priorities and perspectives both for the near or distant future. Foxtrot nodes are already present on the Internet and are ready to be added with specific communications and to become nodes within the Smart Grid as well.

Why is Tecomat Foxtrot is so popular?

Description of the main features of Tecomat Foxtrot system

Control system Tecomat Foxtrot is unique on the market thanks the combination which uses a central control system complying with international standard PLC pursuant to EN 61131, and thanks to own proprietary two-wire installation bus CIB – Common Installation Bus®, integrated Ethernet port, and up to 4 serial ports, integrated mass storage memory utilizing up to 32GB to store large amounts of data, and custom web sites. Integrated web server and freely programmable custom-built web pages directly connected to all measured and controlled variables. Further, small consumption of electric power – around 2W, makes the Foxtrot system an ideal base for a universal and modern digital home. It also significantly saves energy resources

thanks to the application of the energy management principle used in buildings controlled by the system, (heating, cooling, heat recovery, prevention of resource waste and optimal resource management), and also thanks to very small consumption used by the central module – 2W as mentioned above, which is significantly less than most other intelligent building management systems based a PC server with higher permanent consumption.

Control system Tecomat Foxtrot is a tool used by companies focusing on design, electrical installations, integrations and programming services

Thanks to this tool companies are able to create customized solutions with adapted

logic and graphics controlled through switches, drivers, TV or mobile phones or popular tablets. Companies are also able to solve any combination of sources and heating and cooling appliances, photovoltaic systems or even wind power systems. This is why Tecomat Foxtrot significantly differs from other products available on the building automation market where each control system is more or less focused on one technology, but to control all common combinations of devices used in homes from one central system, all systems produced by competitors need to be supplemented with other systems. It is often Tecomat Foxtrot which is usually selected as the additional system to supplement these – usually foreign control systems. This includes for example Lutron, Crestron, AMX (foreign systems), or Cue (Czech sys-

tem, mainly sold abroad). Some companies offer Tecomat Foxtrot as a whole unit or as their own hardware under their own brand or market name such as Haida, iNELS II, Smart distribution system, Domotron (all in Czech Republic or Slovakia), Inova (Brazil), Kremsol (Holland) etc.

Tecomat Foxtrot was designed to allow other companies to deploy the system anywhere in the world. The system is designed as a global product and it supports all language versions. For example, there are applications in the world which use this system in Hebrew or Azeri language.

Tecomat Foxtrot is built on industrial basis

Foxtrot is available on the market for system focusing on various fields of automation – industrial automation, measurement and regulation/control, building automation, intelligent houses, and always as an industrial PLC. That means that it is an extremely reliable and durable product with an exceptionally long life, which is of course, is appreciated by any user. It is a significant advantage on the building automation and intelligent home market. As we do not bother with the life of components in our cabinets – because they last very long, we do not bother with the life of Foxtrot system, as its life exceeds several times the life of conventional control devices used in buildings. Its well-deserved place at the market is demonstrated, for example by great references provided by the Czech Railways, Nicosia and Larnaka cities, which built telemetry of their water supply network. Near the Caspian Sea the system is used to control traffic on 4-lane highways. It has been seen as the technical standard by ČEZ for 10 years and used in power plants. It is used on the largest photovoltaic power plant in the CR-FV Vepřek. Many heat pump manufacturers use it as the basic control system. In the Netherlands, the system is installed as a control system in yachts and in fire vehicles. In Iran, it is used to control 110km drinking water pipeline, which brings water from a water dam in Larestan to Tehran. It was also deployed and used to control parking access system. In Russia, the system is used to control heat exchangers, and in Prague to control boiler stations located in Prague 6. It also controls an oil terminal in Poti, Georgia.

The system is open and modular

This is a unique advantage and offers virtually unlimited different uses and controlling options for technologies anywhere in the world. Through integrated Ethernet port data are available in both directions through the use of standardized protocols, so it may serve not only as the control element, but also as a communication and data node and combine data or manage objects or technologies separated by hundreds of kilometres. The used technology which offers an access through web pages makes the Foxtrot system ahead of its time because it is compatible with almost all PC platforms, smart phones,

tablets, smart TVs with web browsers and others. It works with Internet Explorer, Firefox, Safari or Opera running on operating systems Windows, Linux, iOS, Android, Bada, and others.

The above characteristics offer exceptional flexibility when dealing with individual and repeatable projects in the so-called intelligent home and building automation field, which are currently being vigorously developed.

A clear trend is the attempt to integrate still separated parts of building technical equipment into a single structure offering remote access, remote control and remote management. In terms of long usage, remote management is one of the most important features: the client can be sure that if future changes are applied, he will not be left alone. Tecomat Foxtrot system is a modular customizable and extensible kit suitable for every project with any number and types of sensors and actuators, or in other words, with any number of binary or continuous inputs and outputs.

Thanks to its mechanical design, the system is modular and compatible with conventional circuit breaker modules. It is intended to be integrated into technical background of a house and may be installed in conventional circuit breaker cabinets using DIN rail. Connection of Tecomat Foxtrot with other elements may be done with centralized cables where all inputs and outputs are concentrated in one or more distribution cabinets, from where monitoring and control cables arranged in a star pattern go to each switch, lighting, blinds, socket etc. However, because the system is based on bus, it is possible to design it with distributed actuators and sensors using 2-wire CIB bus up to 400 meters long. The bus may be branched out freely and does not need any terminating elements at its end. Both methods may be combined. You may connect to the Tecomat Foxtrot central unit (in addition to components connected via cables) also RFox wireless modules. That way you may create up to 4 own wireless networks and each master network may pair with up to 64 wireless modules such as keychain, temperature, humidity or CO₂ sensors, heating unit control heads, etc. An integral part of the system also includes expansion modules designed for distribution cabinets, modules designed for installation into regular installation boxes or under lids of another devices, modules with high protection class IP-65, and interior modules, in particular multiple switches designed by established companies, and also temperature, humidity, smoke, and CO₂ sensors, etc., and components used to set required temperature, light sensors or IR receivers used to control air conditioning or AV equipment.

As far as the user is concerned, Tecomat Foxtrot offers both classical wall switches – mentioned above, as well as control devices connected via IP port. This may be a computer TV, AV multimedia system produced by another manufacturer, wall-mounted touch screen or any browser in a smart phone, tablet, computer, or a device accessible via the Internet.

Communication and connection with third parties

Very important feature of the system is the ability to communicate at the level of serial ports and via Ethernet/internet port. These communications are necessary in order to be able to connect with other “smart” devices in your house, such as homologated security systems (DSC, Teconalarm, Galaxy, Paradox and Jablotron) CCTV/camera monitoring systems (IP cameras), access systems (intercoms, biometric data readers and RFID cards, Assa Abloy locks). The system also communicates with heat pumps (Nukleon, PZP, AC Heating, ACOND, Regulus, Neota, GeoSun), gas boilers (OpenTherm), ventilation and heat recovery systems, air conditioning units (LG, SAMSUNG, CoolMaster), with lighting and roller/ blind systems (LUTRON), and also with household appliances for example, Miele. Audiovisual systems are often used with intelligent building control systems (Control4, AMX, AVIT, Bang & Olufsen, Bose, CYP). The system is very open which allows the system to connect through the applicable interface with other systems used in intelligent buildings, especially with the KNX system. This connection will provide the KNX system with all the benefits offered by central management, and will allow the system to communicate with the outside world.

The system is equipped with a counter which read pulses from heat meters, and with communication converters for reading smart energy meters via M-Bus. Wireless meter reading via the Mbus protocol is currently in the preparation phase. Tecomat Foxtrot provides users with tools for effective control of energy consumption and savings.

The central control unit Tecomat Foxtrot is integrated with a programmable data logger – a recording device, which stores measured values and internal states in a long-term memory. It may also save text messages or pictures from cameras. It may also maintain a diary of events and send data to external database servers.

Foxtrot does not limit the application size

If you use large applications, you may interconnect individual central units of Tecomat Foxtrot using serial lines or especially, the Ethernet. This will allow you to automate any large buildings, such as hotels, office buildings, sports facilities and so on. The central units exchange data between each other, so the entire system behaves like a single control system operated from the control room (dispatch room), using PC running for example, a visualization system SCADA RELIANCE.

The entire Tecomat Foxtrot system may be programmed pursuant to IEC 61131 (also pursuant to CSN, EN). Programming may even be done under full operation, so the end customer is not left, not for a second, without an active control system.

Free programming

Mosaic programming environment (Teco a. s. product) is a top product in its category. It has no equal competitor on the domestic market, and around the world it is being compared with CoDeSys, which is used for example by WAGO, ABB, Beckhoff, EATON, and by approximately other 130 companies. You may use this system and start programming even without much training, which has been confirmed by customers in the Netherlands, Russia, Iran, and Israel, as the system is has been programmed by customers who have never took any training.

Simple parameterization

Tecomat Foxtrot may also be used for simple standard applications in smart homes and building automation systems. It may be configured and parameterized using FoxTool even without any programming knowledge. This allows you to set all common features that are used for building and house management. The system may be installed by any electro-installation company without having any programming knowledge.

Remote access

Programming and diagnostics may be performed remotely over the Internet. This saves service worker deployment cost and also time and fuel. As a new feature we have introduced a "Firmware updater", which allows you to update the firmware of all or only selected modules anywhere in the world. The latest firmware is available in a "cloud" accessible via Internet. Another significant improvement of the Tecomat Foxtrot system is a service called TecoRoute, which has been running since January 2014. This service is designed for remote management of PLC Tecomat Foxtrot over the internet. There are two basic services:

Direct connection and full Mosaic programming functionality.
 Direct access through web browsers.
 The main advantages of this method connection method are:

- No need for public IP address.
- No need for any additional hardware.
- No need to adjust any path and to transfer address or set VPN parameters.
- The connection is not affected by changes in Internet connection – change of provider, change of address in LAN etc.
- Enhanced security – PLC not identifiable from the outside.

Compatibility and long service life

Over 38 years Tecomat control systems have always designed with maximum service life and reliability in mind. There are still several systems that control continuous processes – e. g. the Singing Fountain in Mariánské Lázně which has been in operation since 1986 and still use our system NS905, or the Křižík Fountain at the Exhibition in Prague, which is only about 5 years "younger". Another great benefit is that we produce spare parts

Tecomat Foxtrot® - System Overview

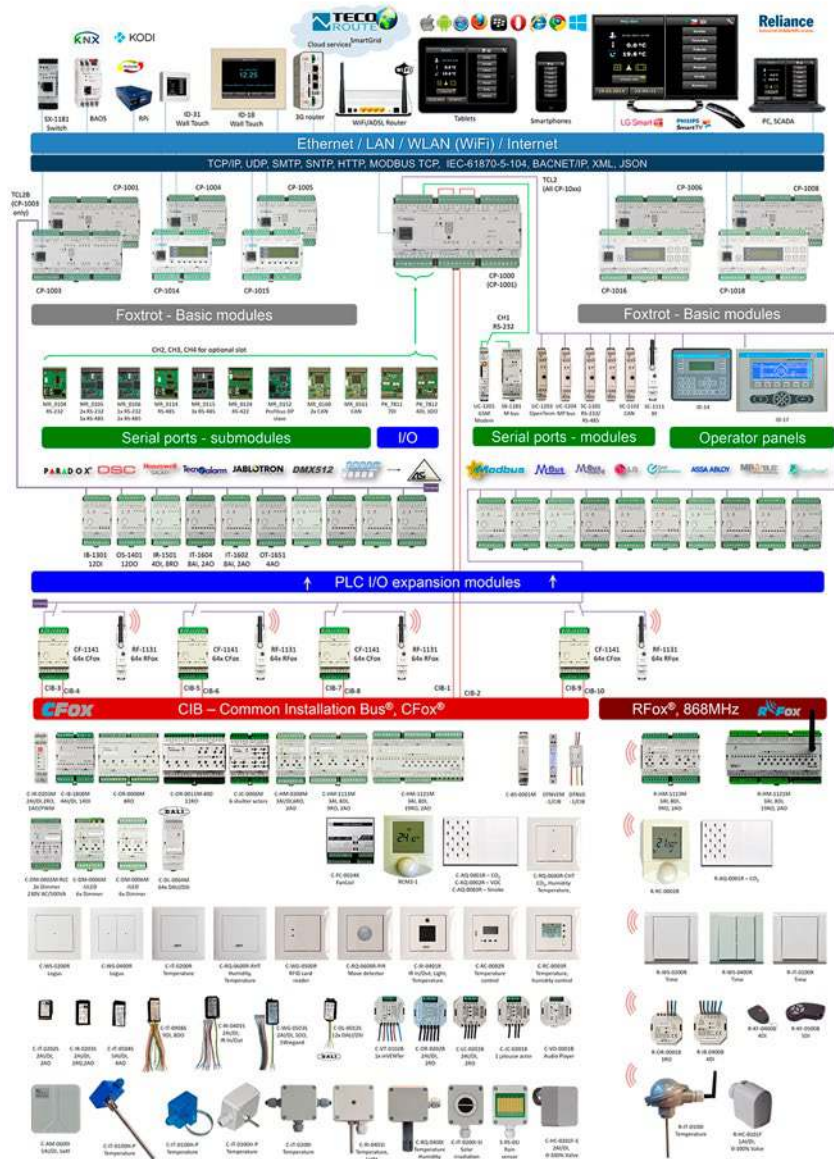

System Tecomat Foxtrot is a complex system of central modules and expansion modules, communication buses and protocols, opened for integration with other systems and latest technologies.

for our control for at least ten years after production of the individual generation of control systems.

Therefore, a customer purchases a product, which will be serviceable for many years to come and will not be forced to keep buying new and new products, which is an unfortunate standard in all sectors and even for reputable manufacturers.

During the development and manufacture of our control systems we strictly observe full compatibility requirements, which allow the customer to extend the old system using new components while keeping the entire system simply programmable and controllable using one programming environment. If the old or existing old control system needs to be expanded, it is not necessary to discard the entire existing system and install new system. You may simply expand the control system, which is financially much less demanding.

Tecomat system structure

Control system Tecomat Foxtrot consists of a central module and peripheral components. There are several types of peripheral modules:

- Expansion I/O modules
- Communication submodules
- Communication modules for rapid industrial bus TCL2
- CFox module series – modules on CIB used in building automation
- RFox module series – wireless modules used in building automation

Product technical level

The technical solutions used in this product category are, on the one hand, rather strictly tied to a set of standards and directives, but on the other hand, there is a natural effort to find cost efficient but best-suited technical solution. The system is designed as a global product usable anywhere in the world.

The system is designed as a universal system and does not differentiate between regular family house systems, huge crude oil enterprises, telemetric systems used by water supply companies, tunnel or traffic sign control or single-purpose machines. The structure is based on the latest 32-bit RISC processors, the latest models of semiconductor memories, and SMD assembly technology. Each piece is tested under several temperature cycles. Results of burn-in and recovery tests are recorded and evaluated in order to maintain long-term high quality of products. Since 2003 the technical level of our systems has been regularly compared with the leading products at many world exhibitions focusing on automation technology. Many generations of control systems Tecomat are presented in automation classes at universities and high schools as the top domestic representative of the PLC category. Tecomat Foxtrot system has successfully passed several multi-round tenders issued by ČEZ and focusing on suppliers of small programmable devices that will be used during the next 10 years. Not only technical parameters were evaluated, but also service support levels and long-term development programs used in the past as well as in the future. The system made it to the ČEZ vendor list together with companies such as Schneider Electric and Siemens.

Original solution and approach

Control system Tecomat Foxtrot is a unique combination of an industrial control system (an industrial communication bus used in PLC systems) and home and building intelligent management system.

Thanks to installation CIB bus – Common Installation Bus®, and to own Teco, a. s. solution protected by a utility model, the system allows you to connect and install intelligent modules in buildings easily. In total, you may connect to one central module (control unit) up to 320 modules on CIB. As far as intelligent houses and buildings are concerned, a widespread standard built on KNX bus is used throughout the Europe. This standard uses a distributed control method without any central unit. This solution widespread, and there is a number of manufacturers producing modules and components based on this standard, but because there is no central unit for KNX bus, or rather this bus was not designed to follow this standard, it may only be used to solve simple control functions. In addition, all control algorithms must be programmed for individual modules by the factory. In practice this means that a designer creating an intelligent building project must search manufacturer catalogues for components and then put these components together in one system in order to provide all the necessary features the a customer requires. However, modern intelligent building projects of today will not be satisfied with only pre-established functions set in the production. Buildings alone including used technologies are more complex every day. For example, heating systems used in new and reconstructed buildings, commonly use

multiple heat sources in individual combinations and connections. Functions built into KNX modules do not respect these individual schemes. Also data acquisition and logging is not possible with KNX systems, precisely due to the absence of the central unit.

This failure to respect the global standard eliminates Teco solution and Tecomat Foxtrot system. The solution is a centralized system, e.g. a system with a central unit, freely programmable using programming languages complying with DIN EN 61131 (languages commonly used in PLC systems which are regularly taught at all middle and high schools in Czech Republic as well as abroad). When using Foxtrot, the designer is not limited by functions. Programming environment Mosaic offers a wide range of preset functions for all used technologies, but at the same time, the programmer may program and add any functions to the library for further processing. This enables control of any involved technologies connected to the system, but it also guarantees that future expansion of the already installed system with new functions or requirements will be possible and that the system may be set again or reprogrammed at any time. CIB bus uses a free topology, and therefore, it may be used to distribute control systems simply and inexpensively across the entire building. It may be branched out anyway you like, or reconfigured in the future. In addition, the system is able to control wireless components, which are used during the system design, and programming in the same way as bus components.

Market position

Control system Tecomat Foxtrot eliminates and fills out, especially on the building automation market, empty spaces and deficiencies of existing solutions offered by competitors. There are groups of companies which offer control solutions based on industrial PLC solutions however, the customer is limited by the range of offered peripheral modules and by the uneasy and cumbersome connections to the central module usually done through industrial buses. This problem eliminates Te-

comat Foxtrot, however, due to this approach there is a considerable increase in price.

In contrast, simple home automation systems usually control devices which mostly operate in a simple ON/OFF/dim mode, but cannot handle more demanding control, weather-compensated control curves etc. Thanks to their own control software customers may choose from predefined basic functions, but cannot use freely programmable control tasks.

Tecomat Foxtrot eliminates all restrictions in both groups, does not limit the customer in choosing other functions which are available now or will be available in the future, and even though this system has become one of the most sophisticated control systems designed for intelligent homes and buildings, this solution is practically the cheapest one available on the market. Today, when we see a significant increase in the number of smart houses and buildings in the Czech Republic, our system has become a major player on the home automation market.

Teco has produced more than 15.000 Tecomat Foxtrot control units (as of January 2015).

Tecomat Foxtrot is constantly expanding

Teco constantly introduces innovations, which further improve the existing Foxtrot system. Whether it is the new 4.3" wall-mounted touch panel or the built-in model available in any colour (easily matched with any wall switch design), or combined wall-mounted temperature, humidity and CO₂ sensors available in various designs that match interior switch designs. Further, an application for Apple or Android designed for mobile devices and allowing individual naming and sorting of rooms, floors and technologies within the controlled house or building and assigned to individual users, will certainly be appealing to many users. Each user may therefore customize the control system to his or her own needs. In addition, if you purchase a new device, you may simply transfer your customized and specific visualization by simply sending your configuration file to the other device.

TECO
Advanced Automation

Projects – Theatre .. “het Punt”

ID-28 Touchpanel

Theater Control
Control of Theaterlights (DMX & KNX), Hitachi HD Projector, Denon BluRay Player, Bose ESP 1240 Audio Controller, Cyp Switch, BrightSign Players and LG Displays. Control by TCP/IP & RS232

HITACHI Inspire the Next
DENON Professional
LG Life's Good
PHILIPS Selecon
BrightSign
CYP

Dutch company B&R Design likes to use Foxtrot to integrate a wide range of branded devices into a Web control site with custom graphics. Here, we see a backstage control system in the HetPunt theater in Vroomshoop.

List of interesting references

Van Der Valk hotel – Veenendaleen, the Netherlands

When in the Netherlands and travelling to the city of Utrecht on the A12 highway, near the town of Veenendaalen, you will see the latest hotel of the Van Der Valk chain. It is a noticeable site. This congress hotel is in full operation since in December 2014. It is the floor with 15 congress halls where three Foxtrot systems play one of the most interesting managerial roles. B&R Custom Design company a Dutch partner of Teco, a. s., finalized a project where Foxtrot systems control and coordinate the distribution of audio and video signals to all halls, control projectors, projector screens and large screens with 4K resolution. Foxtrot also controls shutters, blinds, lighting and ventilation systems and of course, also the temperature in every room. The entire system in the congress halls is connected to the booking system used by ITesso hotel, and Foxtrot – using the established event time plan, creates a comfortable interior climate.

And how is this done?

AV signal control

One of the technical rooms is fitted with a distribution cabinet completely filled with audio/video equipment, along with three OEM Foxtrot systems. Each system controls between three and six halls out of the total of 15.

Two multi-room audio amplifiers made by BOSE are on the top. Each putting out 4kW of power output, which may be divided between 2 and 8 channels. Switch matrix ESP00 is underneath, also made by BOSE. A pair of video signal switch matrixes 4x4 HDMI made by CYP is also used. There are also sources of AV signals: Internet radio and 10 wireless microphones. The resulting AV signals (HDMI by CAT6) are distributed to large halls using the same cable as TCP/IP data. User control interface is done via Foxtrot web pages controlled by ID-28 touch panel in each hall. The control web pages are available on larger sites as well through portable iPads.

Control of each room

Ceiling in each room is equipped with a small unit fitted with modules 1x C-HM-113 mm with discrete and analogue inputs and outputs and with 1x SC-1101 serial channel RS-232/485. These modules control sunscreen blinds, air conditioning system, projector lift and the actual projector, projection screen and blinds between glass panels facing the hallway. There are also motion detectors and wall movement detectors installed between rooms. Automatic logic reconfigurations that control all installed components are based on these sensors. Each room is equipped with a control table fitted with a control box and touch panel ID-28, power socket, and HDMI connector. Tables may be moved around and are connected to power sockets and LAN sockets located in terminals hidden in the hall floor.



Pavilion with a restaurant and conference halls on the upper floor



Hotel Van Der Valk Veenendaleen in the Netherland is noticeable from highway A12.

Lighting system control – control of all LED lights via DALI

Helvar supplied the hotel with lighting units controlled via 18 DALI routers equipped with lights, lighting sensors and several relays. In order to control the light in congress halls using the same control panel and according to needs of a particular event, the control page of each room had to be added with 6 different scenarios. This allows the user to use this page to set any combination of parameters such as the intensity of each group of lighting units in the room for each scenario and at any time. PLC Foxtrot stores these control commands and transfers them to UDP command which is then used to control the relevant DALI Helvar router.

Linkage to the hotel booking system and room climate control

The hotel uses iTesso booking system. Every day Foxtrot systems take information from iTesso based on the schedules of events planned for each room and display them using Brightsign Narrowcasting player on Samsung displays placed in each room and in public areas of the hotel. The information is also used for temperature and ventilation in each room. One hour before the event starts, the temperature is set at 21.5°C and during the event, the user may adjust the temperature by plus or minus 2.5 degrees. One hour after the event ends the temperature is set back to the standard 19°C and the room is ventilated intensively.

Reconfiguration halls

Two large congress halls may be divided by moveable walls into three smaller rooms, or you may create one large hall or large hall with two-space separated combinations. The actual configuration may be entered manually. However, thanks to sensors in the moving walls, the system recognizes the specific configuration and uses this configuration to self-synchronize and control shielding, lights, screens, projectors and AV signal distribution, while making sure that the same program is projected on two or three screens.

Wireless microphone control and central supervision

The office at the Congress floor is equipped with an iPad placed in a removable holder which may be used to oversee all rooms at once, or provide remote assistance to the user of the hall. The office is also equipped with a charging “nest” for all ten wireless microphones. Five of them may be attached to a strip and five are regular hand-held



Canvases and blinds behind them, lifts with projectors, lighting and ventilation after removal of foldable walls (left or right) are switched to the synchronous control mode which applies to the entire triple-sized space.

microphones. When microphones are distributed one touch assigns a specific microphone to a particular room. Several microphones may be assigned to a single room. Foxtrot then directs the signal to the right speakers. In this hotel, Foxtrot system played the role of a unifying graphic user interface unifying a number of specialized equipment supplied by different suppliers. The system also plays the role of a coordinator on the entire infrastructure of the hotel congress floor, even though the system could use its technical resources and directly control each LED lamp or manage all DALI bus branches, as it is able to regulate temperature and ventilation, and control blinds directly. The universal use of this system has been applied here in reverse



Herman and Arjan. Specialists from B&R Design delivered a complete cabinet with AV equipment and control system Foxtrot (3 pieces at the bottom of the cabinet), which controls the hotel floor with fifteen congress halls.



Six separate lounges in a row facing the corridor have glass walls with built-in blinds. They are individually controlled from the control panel in each room.



Avifauna lounge with glass on three sides is one of the most attractive lounges. Shielding of each lounge is controlled by the person who rented the control panel.



Room equipment may be controlled from the touch panel on the table of the chairman as well as from a the hotel manager tablet.



Lighting scene user setting. The final requirement is sent as a command to the subsystem delivered by Helvar.



Video signal and projector control.



Reconfiguration of the hall trio 1+2.

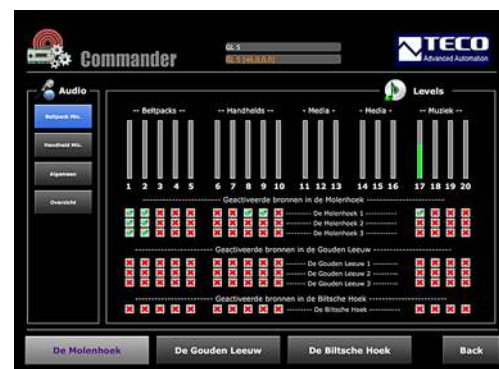

Overview page showing assignment of microphones and other audio sources for individual halls, including volume settings.

Czech manufacturer of solar thermal panels bets on Foxtrot



Another technology company that has selected Foxtrot system for its projects where control and support for remote access is necessary, it is the only Czech manufacturer of solar thermal panels called PROPULS Solar, s. r. o. from Pardubice, which supplies 30 countries worldwide. Solar panels are manufactured under the SunTime brand name and are available in a wide range suitable for installation in both family and apartment buildings, as well as in the public and corporate sector.

The company offers complete installation of solar thermal panels. The company also supplies installation companies not only with its own panels, but also with proven connecting armatures, anchoring and supporting elements, and Suntiware computer systems. In the last year, the company added a system regulation built on Foxtrot. The application SW installed together with the website focus on a combination of renewable heat sources – pellet boilers and heat pumps. PROPULS Solar has become another OEM partner of Teco, a. s. which focuses on rational management of multivalent sources of energy in houses. We wish PROPULS many future successes.



60m2 of SunTime solar panels on an apartment building in Most.



Installation of Foxtrot system in a distribution cabinet at the Police School in Prague.

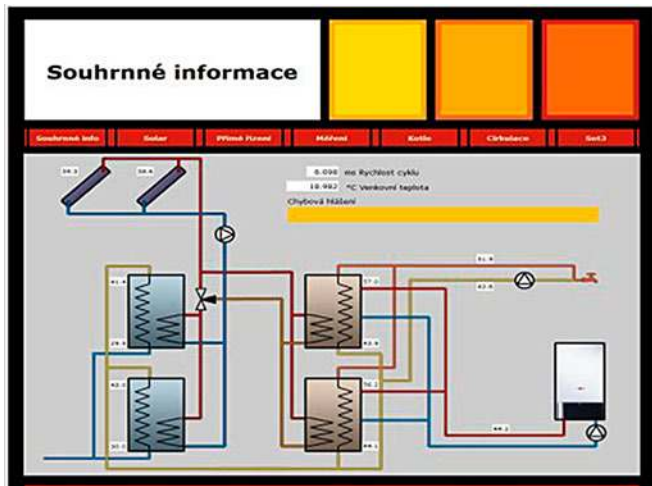

Foxtrot website for remote access to boiler room with a solar system in a residential building in Znojmo.

Comprehensive monitoring of machines at Kovolis Hedvikov



Kovolis Hedvikov in Třemosnice situated in the Chrudim region, annually processes 6 thousand tons of aluminium, and it is the largest pressure injection foundry in the Czech and Slovak Republic. In 2014, KYBERTEC started a supply company called ELKOPO, s. r. o. on behalf of an investor called Kovolis Hedvikov, which supplies machine monitoring system to factories in Hedvikov and Ronov nad Doubravou. Production parameters of more than hundred machines are monitored. Machines are divided into machining centres, press machines and control devices.

The monitoring systems was designed with a distributed system with several dozens PAC Tecomat Foxtrot systems. Data are read either directly through I/O (input/output) or through serial communications. In case of casting machines, it is a rather a unique solution that has not yet been deployed in the Czech Republic.

The processed data are then provided to a host system called Reliance version 4.7.0 where they are processed further. Databases, graphs, or other parameters, e. g. service parameters are available for each monitored machine. Statistics are created in a scripting tool SCADA Reliance. These serve as a general overview of the current performance and machines operation based on shifts and days. To work with SCADA system, the key element is the Reliance Web interface, where both web clients and smart clients are used. As a part of the application a standardized workplace for machine operators with durable PC and Reliance client together with data processing system – which receives data from the company's chip system, was created. Here, the Reliance SCADA system is connected with embedded MES system (data exchange takes place via MS SQL server), which used for complete production management. Information describing product batches, current machine operation statuses as well as other data is exchanged between these systems.

The system was custom built as an open system and prepared for future expansions. This approach was also incorporated in the HW and SW specifications.

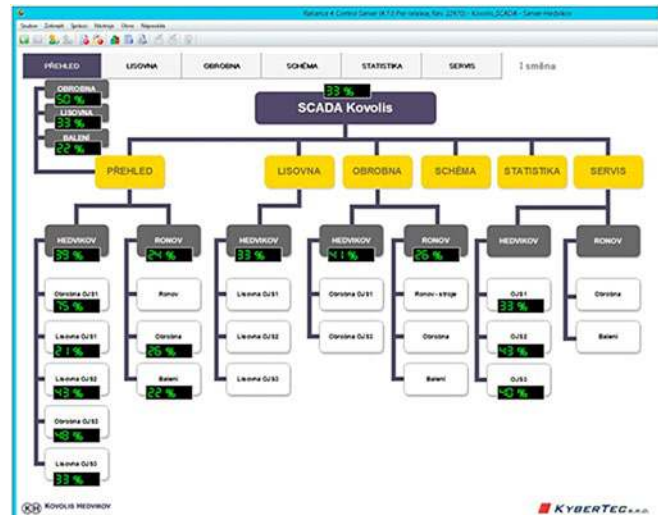

Underground parking access control system in the Sberbank building – Yekaterinburg, Russia



Tecomat Foxtrot system was installed in the Sberbank building in the city of Yekaterinburg, Russia in the Ural region, to control the access to the underground parking garage. The installation was done by our partner available in that region, by a company called Territoriya Kontrolya.

Foxtrot system controls here gate drives at the entrance and exit, Vacant/Full signalisation system and even system which directs vehicles after they enter the parking garage, including lightning of particular zones.



Controlling lights in the AKORD House of Culture in Ostrava-Zábřeh, Czech Republic



The House of Culture AKORD is seen as the flagship and the most important site of the cultural life in the city of Ostrava. A complete reconstruction of the building took place between 2013–2014. The investor was the city of Ostrava. The design is the work of Ing. architect Denisa Barvíková, ateliér d21 architects, s. r. o., lighting system was designed by LUXPLAN company, and the building control system is based on Foxtrot Teco system. EMVT, s. r. o. Ostrava designed the electrical part of the project, programmed it and put it into operation. There is a total of four central modules CP1000 installed in the building, which control the lights, blinds and light scenes. Each CP-1000 units controls the selected portion of the building, which behaves as a separate operating unit. General overview of the light system operation is displayed on a simple panel at the front desk on the 1st floor. The control panel is also fitted with optical and audio alarm, which signals the state of the main circuit breakers and the emergency lighting systems important for the operation. A remote access via the Internet and a simple visualization is prepared for maintenance purposes.

Installed control units:

1. Central dressing room on the ground floor, corridors 1 thru 5. Lighting system on the ground floor and on the 1st floor is made of LED strips installed under translucent sheets. LED strips are controlled via DALI bus. Corridors located on the 2nd through 5th floors are equipped with original refurbished lamps using regular light bulbs. Regular light bulbs were replaced with LED sources and with LED strips.
2. Restaurant, kitchen and bar on the 1st floor. Fluorescent and LED lighting in ceiling lamps in the restaurant – controlled via DALI bus.
3. Music hall, lounges on the 2nd and 3rd floor and office spaces. Fluorescent and LED lamps installed. Foxtrot system also controls blinds and roller and preset light scenes for individual spaces based on user requirements. The Music hall is still equipped with the original incandescent lamps. Three chandeliers, each containing 37 glass spheres, were originally fitted with 60W bulbs. The chandelier was refurbished, and the 60W bulbs were replaced with 7W LED lamps. LED strips were added to the existing perimeter lamps. The actual controlling of each lamp is divided into five groups. The central control of the hall lightning system is done from the music director location.
4. Club AKORD ground floor, bar at the ground floor and lounge near the Club are equipped with overhead fluorescent and LED lamps controlled via DALI bus. Selected light scenes have been prepared. When the club system is running the lightning may be modified or disabled by the music director at the Club.

There is a total of about 680 lamps and 1400 light sources, 580 m² of illuminated ceiling area. The surface is covered with LED strips that are covered by translucent foils. 350 DALI addresses are used to control the illumination system. Foxtrot controls 85 blinds and shutters. Motion sensors connected to binary inputs of the system are installed at selected locations. The system also monitors 16 groups of auxiliary contacts and a total of 64 circuit breakers, which are connected to binary inputs and monitored by an alarm signalling system.

Control, monitoring and evaluation of drinking water supply system in Drogobič, Ukraine



Control system Tecomat Foxtrot was deployed by our Ukrainian partner – OOO-ETA and it is used to evaluate drinking water supplied from wells in Drogobiče. The entire supply is handled by the first pump level supplying drinking water, as specified in the above-mentioned water treatment plant. Each wells is equipped with Foxtrot control system, which monitors drinking water level in a well and based on this information switches the pump supplying the central water storage. All information from individual water resources are transmitted wirelessly (GPRS) to the water supply dispatch. All information is displayed in real time and stored for future use and for possible solutions of shortcomings affecting water supply.

Shift Supervisor – the dispatch personnel has a current overview of the statuses of all pumps, the level of drinking water reserves, and about all service requests. All available information may also be used in other processes handled by the water plant including payments for used drinking water. These data are essential for subsequent billing. A centralized module Tecomat Foxtrot CP-1005 is used here, and data are collected and visualized using the SCADA Reliance system.



Controlling lightning system at the interactive World of Technology Museum in Ostrava-Dolní Vítkovice, Czech Republic



Server ČeskéFirmy.com wrote that a unique interactive Museum called the World of Technology and constructed according to the winning design of architect Jan Pleskot was open on 26 September 2014, in the Dolní Vítkovice region. Server Novinky.cz brought us information that on 30 September Jan Pleskot received the Architect of the Year Award at the exhibition called ForArch, for designing the World of Technology Museum. The museum is full of technical gadgets that play with light and light effects, because playing with light while using the actual exhibits is one of the key roles the museum is based on.

We are pleased that Tecomat Foxtrot is used in the background of this lighting system. One single Foxtrot system is able to handle nearly a half thousand of lights on 15 DALI bus branches. Briefly said, this installation includes:

- 1 x main distribution cabinet/switchboard,
- 6 x secondary distribution cabinets/switchboards,
- 1 x CP-1000,
- 3 x C-DM-0012S,
- 12 x C-DM-0064,
- 190 programmable buttons – representing the controlled circuits,
- 479 light fixtures controlled via DALI bus
- More than 600 controlled lamps.

These include lighting systems for:

- outdoor areas,
- exhibition spaces
- cinema,
- theatre hall,
- corridors,
- WC,
- displayed exhibits



Complex control of family house technology, Bratislava, Slovakia



Between 2013 and 2014 a bungalow was built in Bratislava. The owner may be described by Oscar Wilde quote: "I have a very simple taste. Always settle for the best". This quote comes to our mind as soon as we enter the house, immediately followed by a question: Who is the architect? Perfection in every detail that it almost seems strange that a young family with a little daughter lives in this gem.

However, it is not only the visual perfection the owner of this house strived for, but also perfect functionality. This is one of the reasons why the owner equipped his house with intelligent management – the home automation system. Being a technical enthusiast who knows what to expect from an intelligent house, he has chosen Te-

comat Foxtrot system as the part of the final software solution called Domotron installed by Akira Slovakia, s. r. o. This house is riddled with modern technologies. However, if those are to work efficiently and comfortably, they clearly need a superior system that integrates all technologies and give the owner a single interface to control the entire house, including remote control options of course. Software solutions Domotron combined together with Foxtrot brings another important benefit, and that is that any changes in functions and settings the young family may wish to apply during the system life may be done by the family alone without the need to call (and pay) an outside company that deployed system. Therefore, this solution will be most appreciated by those who want to handle many features and building automation options by themselves. Still, customers may fear that due to such a wide range of customization options allowing them to tailor the entire system, they may lose original the settings or do something wrong. Do not worry. Every day the system automatically backs up setting allowing you to go back to previous or original setting at any time.

In this house in Bratislava Foxtrot controls the following technologies:

- lighting system
- blinds,
- heating,
- irrigation,
- gate access control system
- security system,
- CCTV (camera system),
- weather stations,
- jacuzzi.



Rubber welding machine – Slovakia



TC700 control system was installed in 2014 by Slovteco to control a welding machine used for rubber part welding. This machine was designed for thermal welding of variously shaped rubber products. The entire assembly consists of 6 identical machines which function independently. The welding machine is equipped with four welding jaws heated with a spiral coil to the prescribed temperature. Jaws move in vertical direction and grip the product that is to be welded and by pressing both parts together the welding is completed. After the set welding time expires, the jaws will open and a flashing green light will indicated completion of the work cycle.



The control system consists of the central unit CP-7004 and 15" rack fully stacked with input and output modules, and provides heating and controls the temperature of each jaw. The movement of jaws is handled by pneumatic cylinders. Positions of cylinders are retroactively monitored and their positions are evaluated. If a discrepancy in the desired position occurs, and error is reported by a red light, the machine returns to its initial position and the error text is displayed on the ID 08 display.

Comprehensive management of technologies installed in family house in Přerov, Czech Republic



Our regional integrator in Přerov was a company called MICRONIC Přerov, s. r. o., which deployed our Tecomat Foxtrot control system as a comprehensive solution for all technologies installed in the house.

The goal was not only to bring the user the comfort of a uniform control of all the technologies installed in the house, but also to optimize and minimize energy consumption through the control of several energy sources connected to the house.

Foxtrot system controls here the following technologies:

- Control of the floor water heating system in relation to available energy resources.
- Control of electric ceiling heating mats.
- Optimization of tank changing process used by heating and utility hot water coming from different resources, such as photovoltaic heating or a fireplace with a heat exchanger.
- Control of all lights and creation of light scenes.
- Detection and electric power consumption balancing – island system.
- Control of doors and gates.
- Control of security system, safety sensors, window and door magnetic sensors, and smoke detectors.
- Control of access to the building using code keyboard and chips.
- Optimization of total consumption of electrical appliances with the intention to reduce current load – island system.
- Assessment of the reserves and consumption of rainwater collected from roofs and used for garden watering.
- Remote monitoring of sensors installed in Jacuzzi/Whirlpool.
- System weather station.



Lighting system control in Serioplast production hall Levice, Slovakia



In 2014 a reconstruction of the lighting system in Serioplast company located in the town of Levice, Slovakia, took place. The original lamps have been replaced by energy-saving LED lights AL-BEO 147, controlled

by our Tecomat Foxtrot system. This pilot project was implemented by a company called Light Project, s. r. o., and the investor – Serioplast company was very satisfied. Employees responded very positively to sharp, white and glare-free light, which was a significant difference when compared with the existing regular lighting used in other Serioplast production plants. Users have the option to automatically control the lighting system based on the time schedule, lighting and movement sensors. Time settings create daily and weekly schedules, which may be applied to each section of the building, and the system automatically adjusts the settings based on sunrise and sunset time. Thanks to the use of the DALI bus and sensors, which monitor the presence of persons, the system turns ON the appropriate lighting units.

Very surprising were measurements and comparisons of energy consumptions drawn by the original and new lighting system, because after several months of operation the investor came to the conclusion that the cost return on the new lighting system, including the control system, is less than two and a half years. Therefore, it is not surprising that Serioplast is already planning to change the lighting system in other production halls and of course, Foxtrot system will be used.



Comprehensive management of technologies in WOMBAT office building Brno, Czech Republic



WOMBAT, s. r. o. focuses on special remediation technologies used for pipelines, trenchless technology and operates throughout the Czech Republic. When building this new project, WOMBAT specified the need to have fully automated operation of this new office building together with remote administration/management (multi-level control including partial control of tenant heating systems, for example).

Our Tecomat Foxtrot system was installed in this building by ELEKTRIKA BRNO, s. r. o., and RAMECO.CZ. The system is based on a pair of Tecomat Foxtrot CP-1000 units.

Foxtrot system controls the following technologies:

- Lighting of the building (58 rooms + garage hall)
- Heating system,
- Shading,
- Ventilation,
- Building access system (RFID chips + PINs)
- EPS
- And others – for example, waste sump status monitoring, remote meter readouts or even the access of selected persons to the coffee machine located in kitchen based on their RFID/PIN...

The application is visualized through integrated Web server in the central unit, and may be accessed remotely by the building manager and tenants. Web servers in the PLC visualize lighting floor plans, heating, ventilation, access control system, EPS, utility media readouts (electric meter, sump level, etc.).

Automatic grinding machine used for inner grinding operations, Prague, Czech Republic



KASKO Praha provides complete services focusing on the development, design and manufacture of special purpose machines and devices using high level of automation and requiring minimal operator interference, especially grinders, milling machines and many more.

One such example is the automatic grinder BD NC 80 used for internal grinding operations and designed for grinding cylindrical and tapered holes in large-series production and for wide range of operations. The grinder may also be used for custom work.

Tecomat Foxtrot system was used to control this machine.

Basic machine specifications:

- Range of grinding diameters: 3–50 mm
- Max. hole diameter: 80 mm
- Max. work piece diameter: 250 mm
- Max. work piece length: 80 mm
- Tilt of the drive spindle: -5° to $+30$
- Drive spindle speed: 400–1500 min^{-1}
- Grinding spindle speed during grinding: 57 600–72 000 min^{-1}
- Grinding spindle speed during finishing operations 50% of the preset grinding speed
- Max. longitudinal movement of the grinding table headstock: 190 mm
- Max. cross movement of the driving headstock: 130 mm
- Max. speed of the of the grinding headstock: 120 $\text{mm}\cdot\text{s}^{-1}$
- Machine power input (depending on used special accessories): 10 kVA
- Vacuum coupling diameter 100 mm
- Machine weight (without accessories): approx 1 950 kg
- Working environment: standard according to CSN 33 2000-3

Electrical section

Used: CP1005 + FX7812, IB1301 – 3 x, OS1401 – 2 x, GT1753.

Control: Z axis – longitudinal, axis X – cross, hand wheel for both axes. Analogue dial indicator: grinding wheel and the drive spindle rotation.

Original machine: hydraulic.

New machine: servo movement and ball screws.



Comprehensive management of family house technologies Debrecen, Hungary



Between 2013 and 2014, our Hungarian partner Home Intelligent Systems, deployed Tecomat Foxtrot system in the City of Debrecen, Hungary, to control technology in a two floor family house.

Foxtrot system controls here:

- Lighting,
- Heating, cooling, independently for each room,

- Blinds,
 - On-line communication using a security system Paradox.
- Heating system used in the house is designed as follows – the ground floor is heated by a floor heating systems, and radiators are installed on the second floor. Water is heated by a gas boiler that heats water as needed (depending on the outside temperature, the desired temperature, and on PID control). Cooling is handled by three Mitsubishi air conditioning units, integrated into Foxtrot via IR modules. Paradox Security system supplies Foxtrot (in addition to other information), with information on movements occurring in rooms. This signals come from individual motion detectors, and based on this information Foxtrot automatically turns ON lights in corridors, turns OFF heating if windows are open (window contact), etc. The whole house is equipped with LED lights.



Klánovice residence development project, Czech Republic



Based on our Tecomat Foxtrot system, a company called HAIDY, a. s. has prepared three types of home automation solutions. Under the name HAIDY Home, the company has created a modular pre-programmed solution for an affordable price, thanks to which this product is suitable for mass deployment in development projects or for distribution through companies providing electrical installation services. One of the development projects where this cost-effective solution was deployed, is the residence in Klánovice. Each unit uses HAIDY Home control system which is already included in the basic price of the equipment. This guarantees to the client that the apartment will be properly and effectively heated or ventilated.



Residents of each apartment may add to this system a safety system, blind control system or energy measuring devices. They can even comfortably control the lighting system.

Comprehensive control of technologies in a family house in Warsaw, Poland

In Warsaw, Poland our Polish distributor, IQ BMS s. r. o., in cooperation with a local integrator deployed our system Tecomat Foxtrot for comprehensive management of technologies in a family house that has been recently completed.

Foxtrot controls here:

- Lighting – dimming, lighting scenes,
- Gates,
- Heating – heating zones, time schedules,
- Blinds.

The house is fitted with system switches on CIB designed by Logus90 ANIMATO, which also measure the temperature, and thanks to integrated LED also indicate the status of the controlled device.



Building Management System in My Story hotel in Lisbon, Portugal

InfraSecur is a company from Portugal focusing on building automation systems but is also active outside of Portugal and operates in Angola and Mozambique, where it uses its own branches. In terms of industrial focus, the company provides automation systems for medium and large projects – hotels, hospitals, commercial and industrial buildings, etc. The company became interested in Foxtrot system thanks to its huge flexibility, allowing integration of virtually anything, and as well as due to the affordable price. Lastly, also the robustness of the system tested and proven over many years of operations in many countries and in different climatic conditions played a role. Thanks to InfraSecur, the first installations of Foxtrot



system in Portugal have already been completed. We would like to mention the installation in My Story Hotel in Lisbon.

Foxtrot controls here:

- Lighting,
- Recovery and ventilation,
- Fire shutters and alarm,
- Energy consumption measurements – electricity, water.

Metal scrap crushing technologies, Budapest, Hungary

MU-GO Ltd. is one of the largest scrap metal processors in Hungary. The main business of the company is the collection and storage of metal scrap and recycling. The main company plant is located in Budapest on an area of 32,000 square meters, which processes annually 100,000 tons of ferrous waste.

Hydraulic scrap metal crusher is used to crush separated metal scrap of particular sizes. Hydraulic crusher made by HENSCHEL and providing 850 tons of pressure was used in this project. The crusher needed a control system upgrade, due to many daily breakdowns, which resulted in low productivity and service requirements.

A company called Szinusz Épületautomatika Kft., our Hungarian distributor, carried out the upgrade. The original sensors and actuators were preserved, and only the central unit was replaced. Unit Foxtrot CP-1004 and expansion modules on high speed TCL2 bus were used to monitor and control the crushing process.

The original mechanical control interface was also replaced. Now the system allows the user to monitor individual work tasks and machine statuses on all devices with a web browser, and in this particular case on the operator tablet. This remote control method reduces downtimes.

List of installed features and services:

- Real-time control, and monitoring of input and output data,
- Manual and automatic modes,
- Service functions
- Hydraulic oil temperature and level monitoring
- Work hour counting,
- Full process control.

Used Tecomat Foxtrot modules:

- 1 x CP1004
- 2 x IB-1301
- 1 x IR-1501
- 2 x OS-1401



Luxurious Lutron and Foxtrot LU

Thanks to the involvement of KD Electronics, which in the Czech Republic acts as a dealer of an American company called Lutron and as a distributor of the Danish company Bang & Olufsen, and Teco, a. s., a new OEM version of Foxtrot system attached with the LU suffix was created. This system is exclusively distributed around the entire world by a company called KD Electronics. Together with a company called Elpramo, these companies integrate this system into above-standard interiors that combine quiet blind and roller drives, dimmers and LUTRON wall switches designed with a luxury metal look together with the ability of Foxtrot to control all heat and cold sources and to manage the climate in every room

separately. The actual control of the unit is integrated in one place – the Foxtrot website. From here the integration continues to a tablet or other mobile device possessed by each household member. However, the important foundation of the system remains on walls, where assemblies of multiple pushbuttons and switches are added to the thermostats C-RC-0003R on the CIB bus sharing the same Lutron design. An extra feature is a two-way communication of Foxtrot with audiovisual system Bang & Olufsen, which may also be controlled by Foxtrot or may be controlled by Bang & Olufsen. We were allowed to see two private residences in Prague just before completion and we would like to share a few details with you.



Wall switches with a combination of thermostats C-RC-0003R-Lutron on CIB equipped with multiple press buttons, which are Lutron's specialty – supplied by KD Electronics – and a traditional switch or wall outlet.



Lutron system controls blinds and window rollers as well as lighting units made by Artemide or backlighting of the onyx kitchen wall. Control pages with graphics shown on a tablet running Elpramo graphics.

Racks with Foxtrot and Lutron in the technical background of the house communicate between each other, but they appear to the user as a single integrated system.



The climate in the house and in every room is controlled by Foxtrot. Starting with the heat pump, the individual heating branches, underfloor heating, radiators, heat recovery ventilation and air conditioning units in every room. Everything is visualized on the tablet.

TecoInfo – Newsletter
for user of Teco, a. s. systems
Published by: Teco, a. s., as non-periodical
publicaton. Issue 36 published in March 2015.
Produced by: team of authors under editorial
leadership of Petr Ovčáček
Photo: Teco and authors of articles

Contact:
Teco, a. s.
Havlíčková 260
280 58 Kolín IV
tel.: +420 321 737 611
fax: +420 321 737 633
e-mail: teco@tecomat.cz
www.tecomat.com
Tecomat, Foxtrot, CFox, RFox, FoxTool
are registered trademarks of Teco, a. s.

