

# REFERENCE MANUAL



# PX<sup>T</sup>

PERFORMANCE EXCHANGE™ FOR TRANSMISSIONS



## General Information

The BG PXT™ Performance Exchange™ for Transmissions is not a piece of equipment — it is a complete transmission service! Modern automotive transmissions and their related parts suffer from overheating due to high operating temperatures in cramped quarters. This causes the Automatic Transmission Fluid (ATF) to oxidize rapidly, affecting transmission performance in many ways.

Conventional drain and fill methods of changing the transmission fluid can only remove one-third of the transmission's actual fluid capacity. The remaining old, oxidized fluid simply contaminates the new fluid and often the mixture causes more damage than if the old fluid had been left alone. Also, no efforts were made to chemically clean the inside of the transmission since dissolved contaminants could not be removed.

The BG PXT™ is the ultimate solution to effective transmission maintenance for all types of vehicles — regardless of age.

The BG PXT™ begins with a thorough cleaning using BG Quick Clean for Automatic Transmissions, PN 106. ALL internal transmission components are cleaned. This includes the valve body — which is the control center, the torque converter; oil galleys and clutch pack and filter screen. ALL externally connected components including transmission lines and coolers, are cleaned as well. Cleaning lines and coolers is so important that OEMs recommend this service and offer specialized tools for cleaning these components.

Next, the BG PXT™ removes all the old fluid and cleaner while simultaneously installing new ATF of the exact specification required for each and every vehicle. The BG PXT™ operates cleaner, faster and is more economical than conventional drain and fill methods. The amount of ATF used can be tailored to each vehicle allowing the technician to minimize service cost.

The final step in the BG PXT™ is the installation of BG ATC Plus, Automatic Transmission Conditioner, PN 310, to restore pliability to seals and prolong new ATF life by protecting it from the ravaging effects of oxidation.

The BG PXT™ is not a repair service — it is a *maintenance service*. A thorough inspection of the transmission (including related components such as lines and coolers) should be performed and all repairs made before performing this service.

Check the vent on top of the transmission to be sure it is open and functioning. Inspect seal areas and gaskets; replace any that are leaking or badly deteriorated. If the pan gasket needs replaced, it is recommended the transmission filter be replaced as well. In fact, the filter should be changed any time a repair service requires that the pan be removed. Check hoses, metal lines and connections to be sure all are in good repair.

**PXT™ PERFORMANCE EXCHANGE™ FOR TRANSMISSIONS**

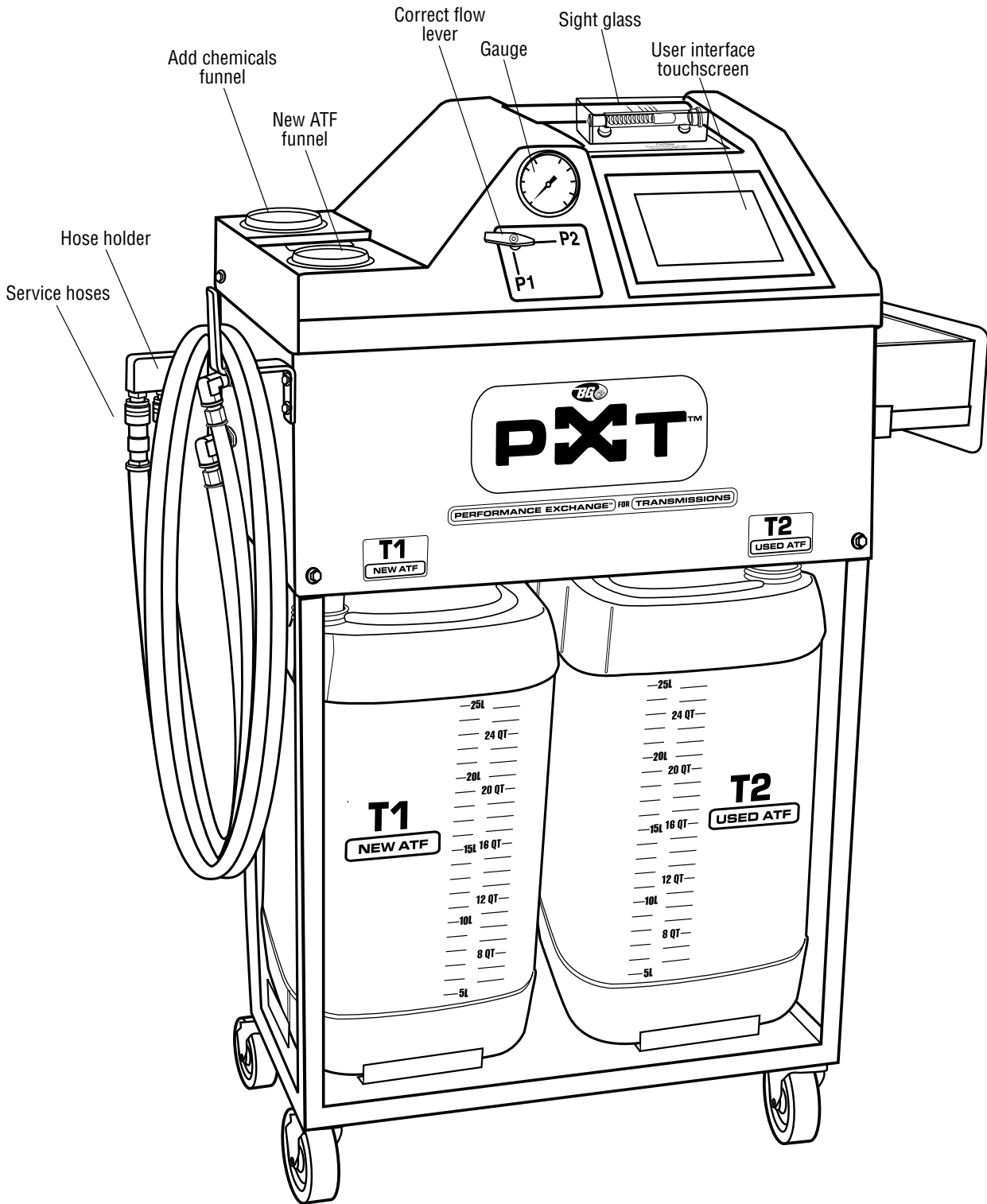

## Specifications

- Height: 43.5 inches/1.015 meter
  - Width: 28 inches/0.711 meter
  - Depth: 15 inches/.381 meter
  - Fluid Capacity: 7 gallons/28 quarts/26.5 liters
  - Filters: 4 cleanable wire strainers
  - Construction: Steel frame with heavy duty casters
    - PVC plastic skin and console
    - High temperature, oil- and chemical-resistant hose
  - Power Requirements: 12 Volt DC
  - Process Rate: Average 2–6 minutes, depending on condition and model of vehicle
  - Process Method: In loop with transmission using one gear pump to assist removal of used ATF and a separate gear pump to install the new ATF. The machine uses a processor to compare the weight of the removed fluid with the weight of the new fluid returned to the vehicle.
- MADE IN U.S.A., Pat. Pend.,CE

## Limited Warranty

This product is warranted by BG Products, Inc. to be free of defects in workmanship and materials for a period of 1 year from the date of purchase by original purchaser. If the product fails within this period, it will be repaired or replaced at seller's option, provided (1) the product is submitted with proof of purchase date and (2) transportation charges are prepaid to the nearest Service Center. Liability under this warranty is expressly limited to repairing or replacing the product or parts thereof. This warranty does not apply to product or parts broken by accident, negligence, overload, abuse or if they have been tampered with or altered in any way. This warranty does not apply to service hoses and adaptors which may need replacing due to normal wear. If this warranty does not apply, then the purchaser shall pay all costs for labor, material and transportation. Note: The use of this apparatus for any purpose other than the services described will render this warranty null and void, as will the use of any chemicals other than the BG products described in this manual. No other warranties are expressed or implied.

## Safety Requirements

The following instructions must be read and understood before attempting to set up or use the BG PXT™.

1. Carefully read the BG PXT™ Reference Manual before assembling and using any part of the system.
2. Before handling any chemical, read its Material Safety Data Sheets.
3. Wear safety goggles to protect your eyes.
4. Wear Nitrile, Neoprene or PVC gloves to protect your hands.
5. Wear a long sleeved shirt.
6. A combination of mechanical and local ventilation should be used to prevent operator exposure to noxious fumes.
7. Keep all hoses and tools away from moving engine parts.
8. Check all lines and fittings for cracks and leaks before and after service.
9. Use EXTREME CAUTION when removing transmission lines and/or adaptors before and after the service. Transmission fluid could be under pressure and will likely be very hot. Be very careful in handling connections because they will also be very hot.
10. Dispose of used Automatic Transmission Fluid in accordance with Federal, State, and Local regulations.
11. The BG PXT™ is designed to be used only with BG products described in this manual. The use of any other chemicals or fluids other than conventional ATF, mineral- or synthetic-based, with this system will void all warranties and could create hazardous conditions.
12. Do not spray solvents on sight glass. Sight glass should be cleaned using mild detergents only.

## Pre-Service Instructions

1. Start vehicle engine and run until normal operating temperature is reached.
2. Check automatic transmission fluid level. If it is more than 1 quart (1 liter) low add fluid, but leave room for 11 ounces (325 mL) of BG Quick Clean for Automatic Transmissions, PN 106.

**Do not overfill automatic transmissions.**

3. Add the contents of one 11 ounce (325 mL) can of Quick Clean for Automatic Transmissions, PN 106, through the Transmission dipstick tube (For vehicles without a dipstick, the BG Quick Clean can be added through the BG PXT™ after the connection is made to the vehicle). The vehicle should then be driven for approximately 15 minutes. If it cannot be driven or if the BG PXT™ has already been connected, place the vehicle on a lift so that the vehicle's wheels are above the floor. With the engine running, shift the transmission through all the gears so that the valve body in the transmission is activated. This ensures that the BG Quick Clean gets to all parts. During this procedure, **make sure the brake is fully applied and the drive wheels have stopped turning between gear changes to prevent damage to transmission or differential assemblies.** After adding the BG Quick Clean, the vehicle should not be run more than 30 minutes before performing the ATF transfusion.

**Note: If the vehicle cannot be driven or placed on a lift, chock the wheels, apply brakes (including the parking brake) and carefully shift transmission through the gears several times with engine running at idle speed.**

Vehicle is now ready for the ATF transfusion.

4. Shut off engine and locate a junction in either of the two transmission lines that will allow you to install one of the included adaptors to each end of the junction — see “Possible Points of Connection” in this manual. Separate the line at the chosen junction and attach adaptors. Use pinch off clamps on rubber lines to prevent ATF loss while connections are being made.

**Note: Some vehicles also use the radiator to help cool the engine oil. Be sure the lines you are working with actually go to the transmission and not the engine.**

5. Connect the BG PXT™ service hoses to the adaptors. Either hose can be attached to either adaptor; flow direction will be corrected via ball valve after the vehicle's engine is started.
6. Start the vehicle's engine and check for leaks.
7. Power up the BG PXT™ by attaching the BG PXT™ power cables to the vehicle's battery and allow a couple seconds for the computer to start, then follow the on-screen instructions.

## Preparing the BG PXT for Service

In order for the BG PXT™ to be ready for the next service, there must be enough ATF in the new fluid tank and enough space in the used fluid tank to handle the volume requirements of the next vehicle to be serviced. It is not necessary to start with a full tank of new fluid or have the used fluid tank completely emptied. The BG PXT™ allows for multiple services on one charge (and one emptying) of the machine.

To fill the BG PXT,™ simply pour the ATF into the New ATF fill funnel.

To empty the used tank on the BG PXT,™ you will need to have it powered up by connecting the power cables to a 12 volt DC power supply. After powering up the BG PXT,™ press the "Empty Used Tank" on the touch screen. Follow the on-screen instructions. The BG PXT™ will stop automatically when the tank is empty.

## Care and Maintenance

The BG PXT™ requires no scheduled maintenance although there are 4 strainers (3 in the manifold block and 1 on the used fluid pump) that can be removed and cleaned should the machine start functioning irregularly.

Do not use harsh chemicals or abrasives on either the sight glass or the touch screen. These components should be kept clean using mild detergents and a soft rag. **Do not spray brake cleaner on these components.**

All receptacles used for the transfer of new fluids and chemicals should be kept clean. The New Fluid jug should be removed and washed out if there is any particulate matter on the bottom. The New ATF funnel and the Add Chemicals funnel should be kept covered when not in use.

The tank platforms are supported by load cells that have a maximum capacity of 70 lbs (31.75 kilograms). **Do not step on or drop a loaded tank onto the tank platforms because the BG PXT™ could be severely damaged.**

## Calibration

The BG PXT™ is calibrated at the factory and should not need further adjustment. If the machine does lose calibration contact a BG representative for assistance.



## Possible Points to Make Connections

(Note: It is only necessary to disconnect one line.)

**CAUTION: Be sure the line is a transmission fluid line and not an engine oil line!**

Crossflow radiator with ATF cooler on side

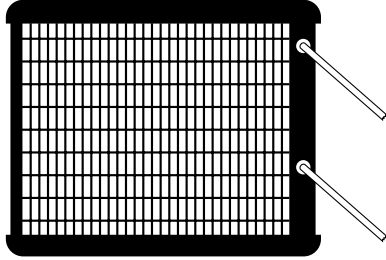

Transmission front wheel drive

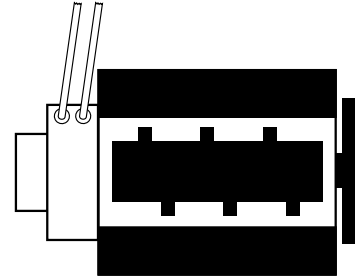

Crossflow radiator with ATF cooler on opposite side

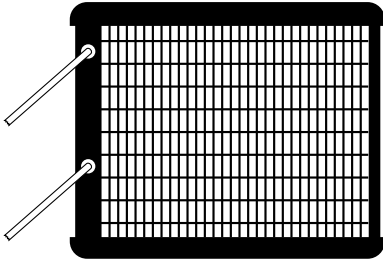

Transmission rear wheel drive

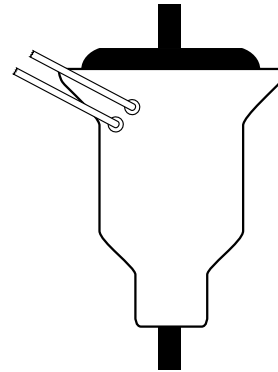

Top tank with ATF cooler on bottom

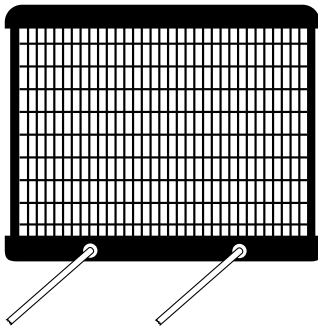

...and opposite side

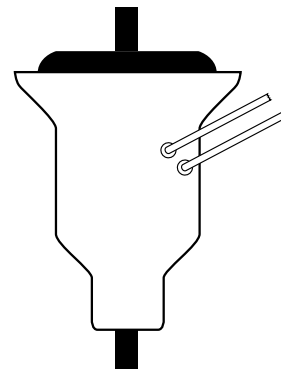

External ATF cooler

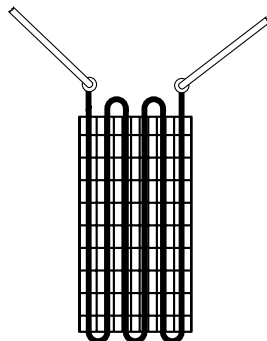

**PXT™ PERFORMANCE EXCHANGE™ FOR TRANSMISSIONS**

Connection may be made at any accessible point along the automatic transmission fluid (ATF) route. However, it is possible that the adaptors may not fit every connection encountered.

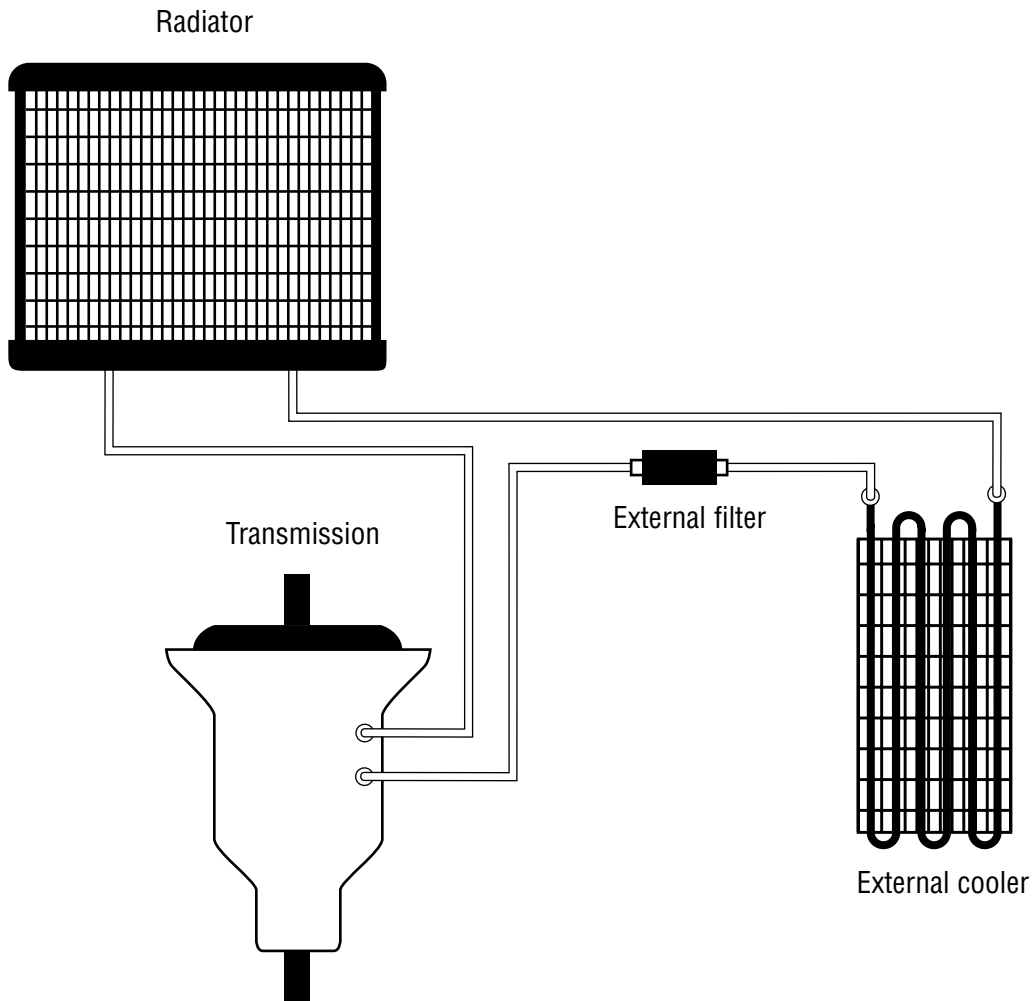

# Plumbing

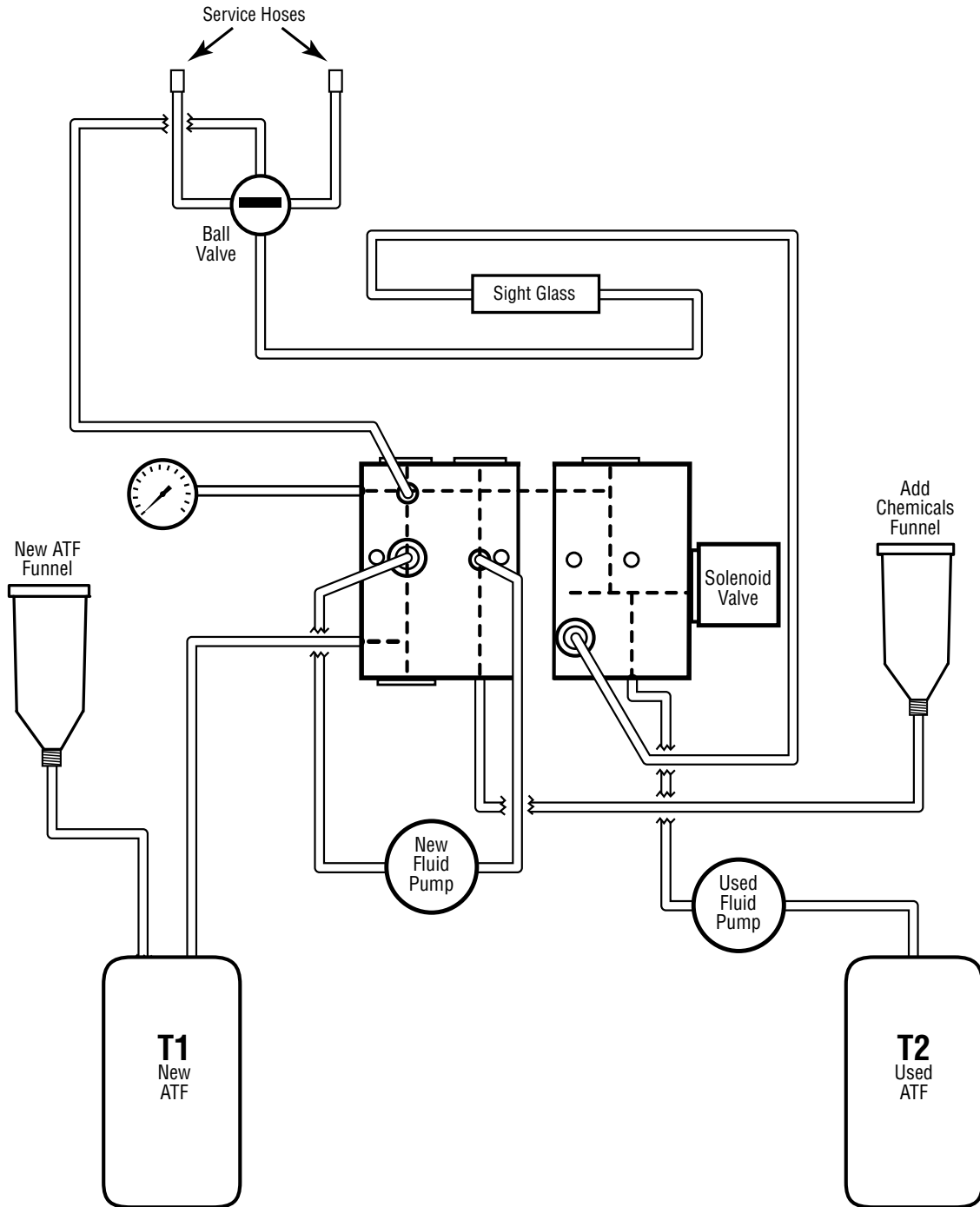

## Quick Connect Adaptor Set (included)

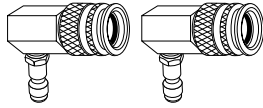

**TF83242QC**  
90° quick connect

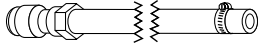

**TF83202QC**  
1/4" open hose, mate 01



**TF83203QC**  
1/4" & 5/16" barb, mate 04

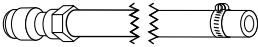

**TF83204QC**  
5/16" open hose, mate 03, 27



**TF83206QC**  
3/8" open hose, mate 05, 25, 35

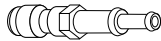

**TF83207QC**  
3/8" & 1/2" barb, mate 08

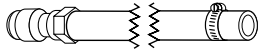

**TF83208QC**  
1/2" open hose, mate 07, 26, 28, 33

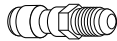

**TF83209QC**  
3/8" male flare SAE, mate 10,  
Volvo, Isuzu, Jeep

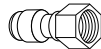

**TF83210QC**  
3/8" female flare SAE, mate 09,  
Volvo, Isuzu, Jeep



**TF83211QC**  
5/16" male inverted flare, mate 12,  
most GM products



**TF83212QC**  
5/16" female inverted flare, mate 11,  
most GM products

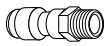

**TF83213QC**  
1/4" male pipe thread, mate 14,  
requires Ford tool P/N 7244 for  
some '85 & later



**TF83214QC**  
1/4" female pipe thread, mate  
13, requires Ford tool P/N 7244  
for some '85 & later

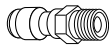

**TF83215QC**  
3/8" male inverted flare, mate 22,  
Jeep '79 & older, some GM



**TF83216QC**  
1/2" male inverted flare, mate 37,  
GM products

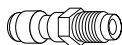

**TF83217QC**  
3/8" inverted flare, long, mate 32,  
Ford, Mercury



**TF83218QC**  
5/16" inverted flare, long, mate 31,  
Ford, Mercury

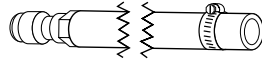

**TF83220QC**  
3/4" open hose, mate 43



**TF83221QC**  
5/16" male SAE, mate 23,  
GM products

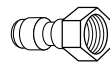

**TF83222QC**  
3/8" female inverted flare, mate 15,  
Jeep '79 & older, some GM

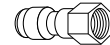

**TF83223QC**  
5/16" female flare, mate 21,  
GM products

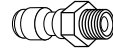

**TF83224QC**  
7/16" inverted flare, mate 38

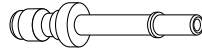

**TF83225QC**  
3/8" spike quick connect, mate 72,  
late Chrysler



**TF83226QC**  
1/2" spike quick connect, mate 79,  
late Chrysler



**TF83227QC**  
5/16" spike quick connect, mate 80,  
Windstar, Villager

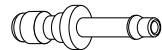

**TF83228QC**  
GM male quick connect, mate 72,  
Blazer, Impala

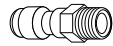

**TF83229QC**  
5/8"-18 male flare, mate 30,  
Contour/Mystique

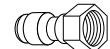

**TF83230QC**  
5/8"-18 female flare, mate 29,  
Contour/Mystique

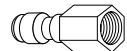

**TF83231QC**  
5/16" long female, mate 18,  
Ford, Mercury

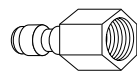

**TF83232QC**  
3/8" long female, mate 17,  
Ford, Mercury



**TF83233QC**  
GM large male quick connect, mate 79,  
late GM only

(continued on next page)



# Quick Connect Adaptor Set (included)

(continued from previous page)

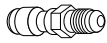

**TF83234QC**  
3/8" male flare, 37°JIC, mate 39



**TF83235QC**  
Male banjo adaptor, mate 06,  
Ford Escort

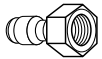

**TF83236QC**  
Female banjo adaptor, Ford Escort,  
use with factory banjo bolt

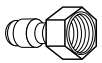

**TF83237QC**  
1/2" inverted female flare, mate 16,  
GM products

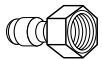

**TF83238QC**  
7/16" inverted female flare, mate 24

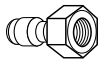

**TF83239QC**  
3/8" female flare, 37°JIC, mate 34

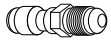

**TF83240QC**  
5/16" male flare, fine thread, mate 41,  
Chrysler truck

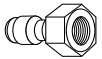

**TF83241QC**  
5/16" female flare, fine thread, mate 40,  
Chrysler truck

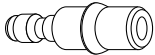

**TF83243QC**  
Pick up w/Allison quick connect, mate 73

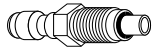

**TF83245QC**  
Jeep Liberty adaptor, mate 77

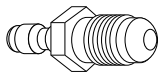

**TF83248QC**  
Male adaptor 11/16"-16 Jeep Cherokee  
mate 49

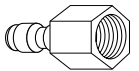

**TF83249QC**  
Female adaptor 11/16"-16 Jeep Cherokee  
mate 48

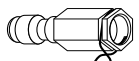

**TF83272QC**  
3/8" GM quick connect female, mate 28, 25  
**TF83272-1** Replacement clip

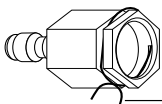

**TF83273QC**  
5/8" GM Quick Connect Female, mate 43  
**TF83273-1** Replacement clip

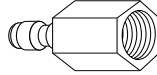

**TF83277QC**  
5/8"-18F Jeep Liberty adaptor, mate 45

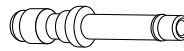

**TF83278QC**  
3/8" male adaptor, Corvette &  
Ford trucks, mate 06

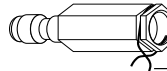

**TF83279QC**  
1/2" female quick connect, mate 26, 33  
**TF83279-1** Replacement clip

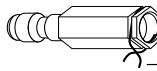

**TF83280QC**  
5/16" female quick connect, mate 27  
**TF83280-1** Replacement clip

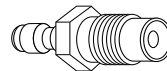

**TF83284QC**  
1/2" male inverted flare-long

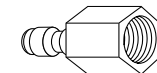

**TF83285QC**  
1/2" female inverted flare-long

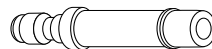

**TF83288QC**  
1/2" male adaptor, F350 Powerstroke

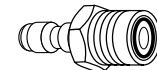

**TF83291QC**  
M18 x 1.5 male GM adaptor

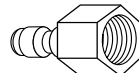

**TF83292QC**  
M18 x 1.5 female GM adaptor

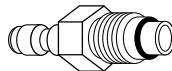

**TF83297QC**  
Transmission adaptor,  
Ford F150, assembly

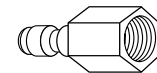

**TF83298QC**  
Transmission adaptor,  
Ford F150, female

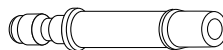

**TF83299QC**  
Transmission adaptor,  
Ford Explorer, '08 until superceded, male

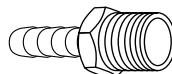

**G0030-0604**  
3/8" MNPT x 1/4" hose barb, straight, brass

Note: Adaptor set contents subject to change.

## Optional Adaptor Set (not included)

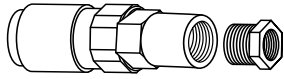

**TF83219QC**  
Recharge adaptor

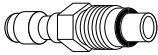

**TF83244QC**  
Male adaptor, Land Rover,  
M18 x 1.5 (Mates w/ #76)

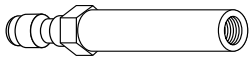

**TF83246QC**  
12 mm banjo, female  
Acura TL (Mates w/ #47)

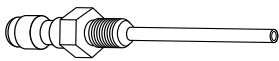

**TF83247QC**  
12 mm banjo, male  
Acura TL (Mates w/ #46)

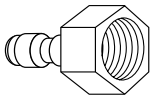

**TF83270QC**  
Female adaptor, Landrover,  
M20 x 1.5 (Mates w/ #71)

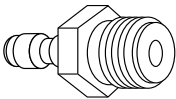

**TF83271QC**  
Male adaptor, Landrover,  
M20 x 1.5 (Mates w/ #70)

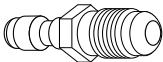

**TF83274QC**  
Male adaptor, Isuzu Cabover,  
M16 x 1.5 (Mates w/ #75)

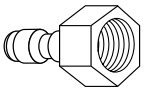

**TF83275QC**  
Female adaptor, Isuzu Cabover,  
M16 x 1.5 (Mates w/ #74)

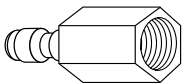

**TF83276QC**  
Female adaptor, Landrover,  
M18 x 1.5 (Mates w/ #44)

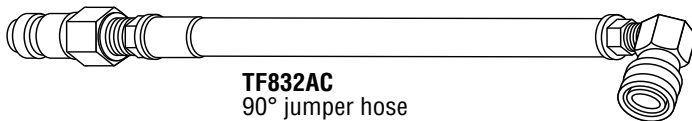

**TF832AC**  
90° jumper hose

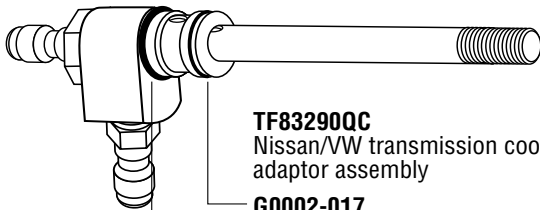

**TF83290QC**  
Nissan/VW transmission cooler  
adaptor assembly

**G0002-017**  
.676 ID x .070 thick, Buna O-ring

**G0002-014**  
.489 ID x .070 thick, Buna O-ring  
(2 O-rings inside unit, not shown)

**G0002-016**  
Nitrile O-ring #016

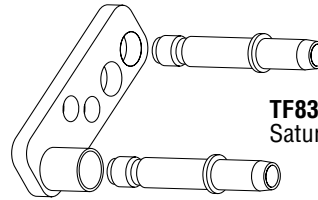

**TF83281QC**  
Saturn adaptor assembly

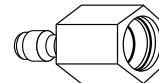

**TF83282QC**  
Allison QC adaptor  
assembly-Chevy Workhorse, female

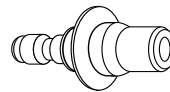

**TF83283QC**  
Allison QC adaptor  
assembly-Chevy Workhorse, male

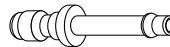

**TF83286QC**  
GM male quick connect-long

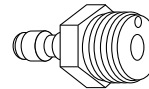

**TF83287QC**  
PF5 drum plug adaptor

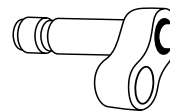

**TF832104QC**  
Transmission adaptor,  
GMC Acadia, male assembly

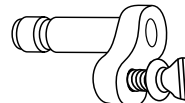

**TF832105QC**  
Transmission adaptor,  
GMC Acadia, female assembly

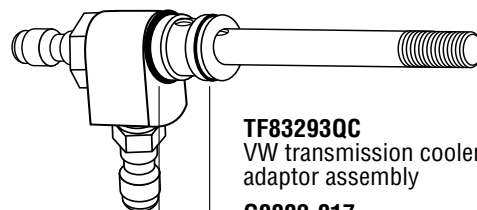

**TF83293QC**  
VW transmission cooler  
adaptor assembly

**G0002-017**  
.676 ID x .070 thick, Buna O-ring

**G0002-014**  
.489 ID x .070 thick, Buna O-ring  
(2 O-rings inside unit, not shown)

**G0002-016**  
Nitrile O-ring #016

(continued on next page)

## Optional Adaptor Set (continued)

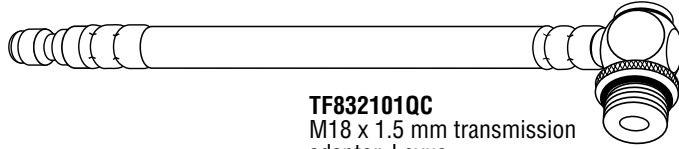

**TF832101QC**  
M18 x 1.5 mm transmission  
adaptor, Lexus  
(optional)

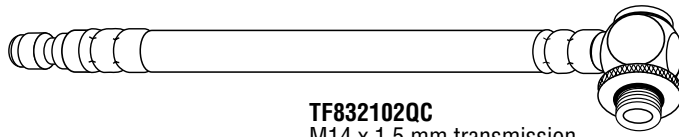

**TF832102QC**  
M14 x 1.5 mm transmission  
adaptor, Lexus  
(optional)

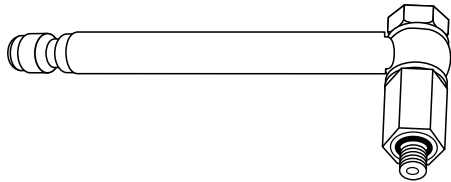

**TF832103QC**  
Pressure port transmission  
adaptor, Lexus  
(optional)

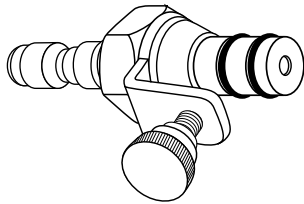

**TF832106QC**  
Transmission adaptor  
assembly Nissan Sentra CVT



**TF832107QC**  
Transmission adaptor,  
Nissan Sentra CVT, test port

## European Quick Connect Adaptor Set (not included)

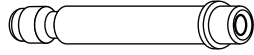

**TF83250**  
BMW transmission cooler adaptor, male

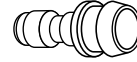

**TF83255F**  
Volvo 850 female adaptor

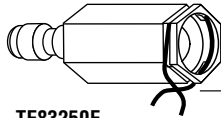

**TF83250F**  
BMW transmission cooler adaptor, female

**TF83250-1**  
Retaining wire

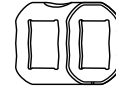

**TF83255C**  
Volvo 850 retaining clip

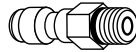

**TF83251**  
Saab 14 mm male adaptor

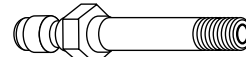

**TF83256**  
VW & Audi single flange bolt (2 in kit)

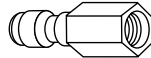

**TF83251F**  
Saab 14 mm female adaptor

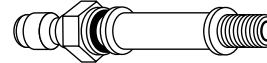

**TF83257**  
VW & Audi double flange bolt (2 in kit)



**TF83252**  
Mercedes, BMW & Audi male, 1985 and newer

**G0002-206**  
O-ring, -206 (.484 ID X .139), Buna

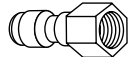

**TF83252F**  
Mercedes, BMW & Audi female, 1985 and newer

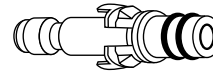

**TF83258**  
Volvo II fitting, male with clip

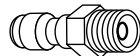

**TF83253**  
BMW & Audi A6 flare adaptor, male



**TF83258C**  
Volvo II clip (*replacement only*)

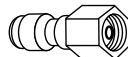

**TF83253F**  
BMW & Audi A6 flare adaptor, female

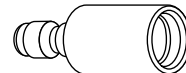

**TF83258F**  
Volvo II fitting, female

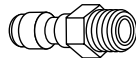

**TF83254**  
BMW O-ring adaptor male, 1987 and newer

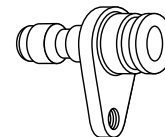

**TF83259**  
Audi/VW male adaptor

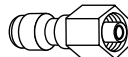

**TF83254F**  
BMW O-ring adaptor female, 1987 and newer

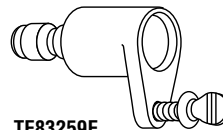

**TF83259F**  
Audi/VW female adaptor



**TF83255**  
Volvo 850 male adaptor

(continued on next page)



## European Quick Connect Adaptor Set (continued)

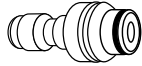

**TF83260**  
Mercedes quick connect, male

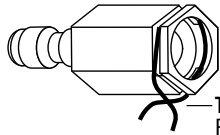

**TF83260F**  
Mercedes quick connect, female

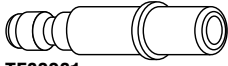

**TF83261**  
BMW/Land Rover 14mm adaptor, male

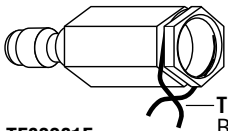

**TF83261F**  
BMW/Land Rover 14mm adaptor, female

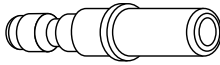

**TF83266**  
Transmission adaptor, BMW, male

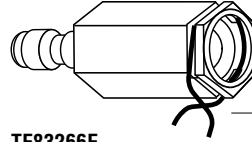

**TF83266F**  
Transmission adaptor, BMW, female

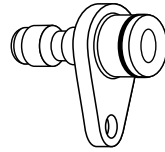

**TF832108QC**  
Transmission Adaptor, VW Tiguan, male, assembly

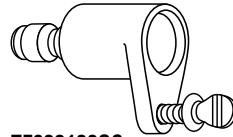

**TF832109QC**  
Transmission Adaptor, VW Tiguan, female, assembly



# Flow Diagrams

## Fluid Bypass

Note: This is the default mode w/no power supplied to the BGPXT

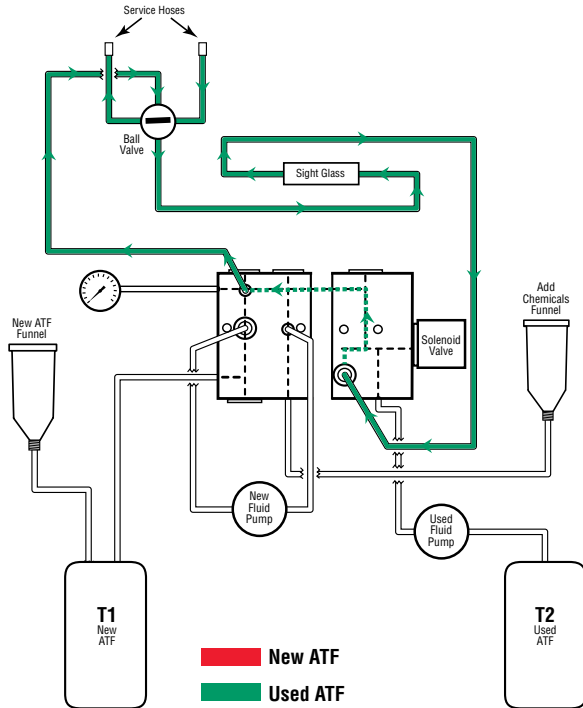

## Fluid Exchange 1

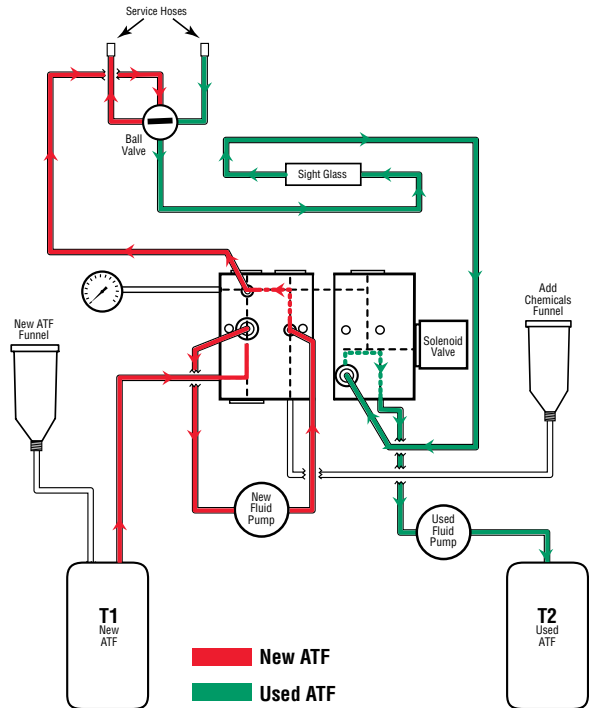

## Fluid Exchange 2

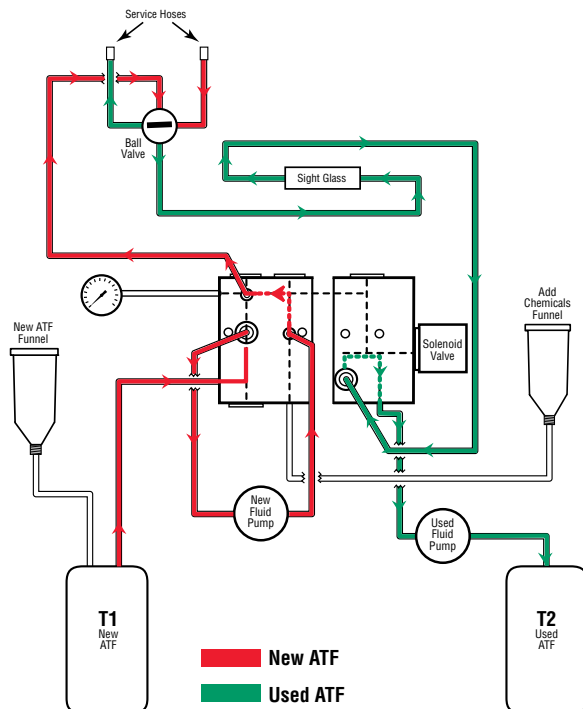

## Adding Chemicals

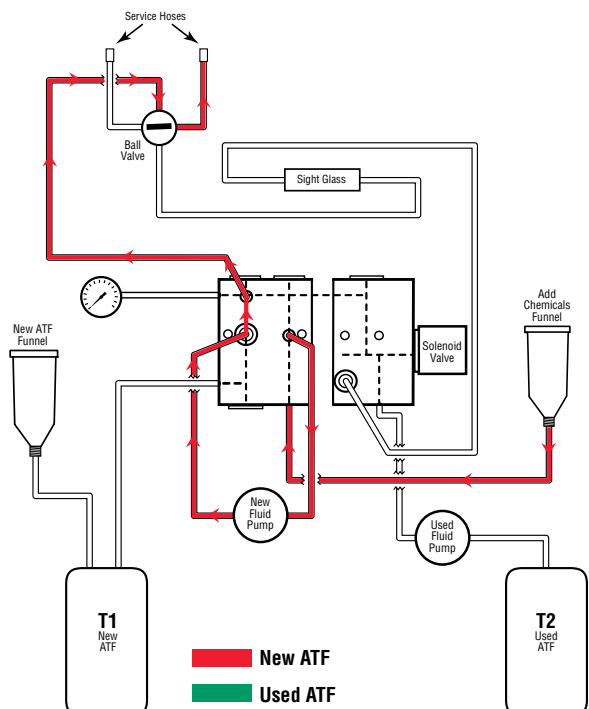

## Flow Diagrams

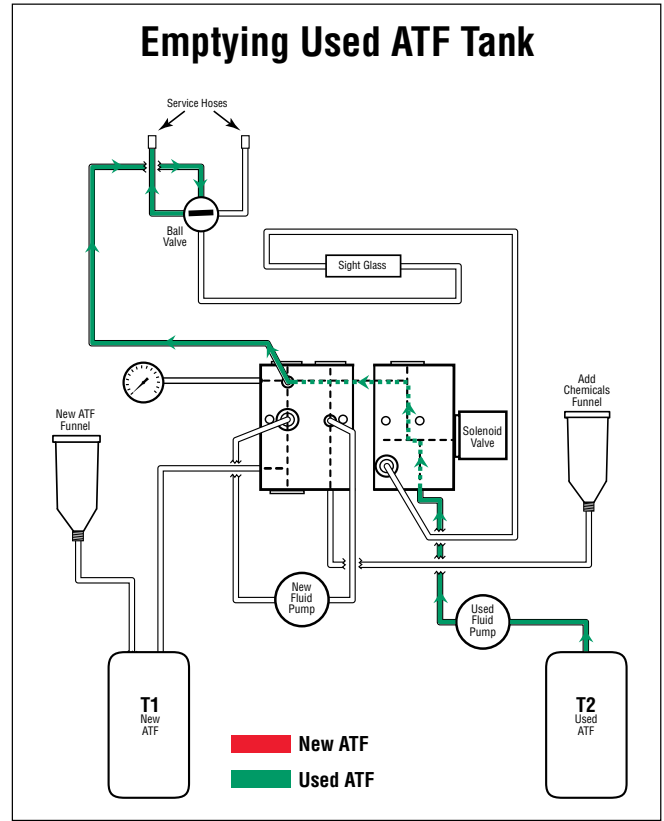
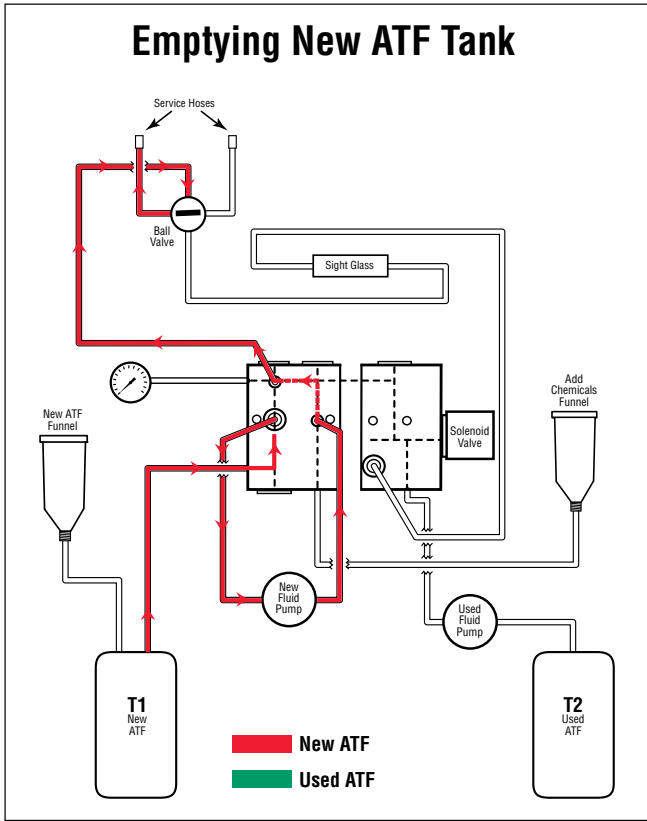



# Barclay-Phelps

CE MARKING SPECIALISTS

Hoi Yuen Road, Kwun Tong, Kowloon, Hong Kong

## CERTIFICATE & DECLARATION OF CONFORMITY FOR CE MARKING

### Company contact details:

BG Products, Inc.  
740 S. Wichita St. Wichita, KS 67213, USA  
Tel: 316.265.2686    rgarcia@bgprod.com    [www.bgprod.com](http://www.bgprod.com)

### BG Products, Inc. declares that their:

- 1) Transmission Fluid Changing Machine  
Models: PXT, PF5-MO, PF5-HO, PF5 and PF19
- 2) Antifreeze Changing Machine  
Models: CT2 and CT6  
including all component parts

### are classified within the following EU Directives:

Machinery Directive 2006/42/EC  
Electromagnetic Compatibility Directive 2004/108/EC

### and further conform with the following EU Harmonized Standards:

EN ISO 12100:2010  
EN 61000-6-2:2005  
EN 61000-6-4:2007+A1:2011

**Dated:** 19 July 2012

**Position of signatory:** CFO

**Name of Signatory:** Ron Garcia

**Signed below:**

on behalf of BG Products, Inc.





Scan this code or visit  
<http://bgfor.me/pxt>  
to access instructions  
in other languages  
and additional information.  
This code can also be found  
on the serial plate  
on the back of the BG PXT™ and  
in the touchscreen display.

