

BSL300 Programmer User Guide

This document is best viewed in a PDF file viewer with the bookmarks pane open and the tools pane hidden. The general section applies to all BSL series modules although all features are not available on all BSL models. There is a section for each BSL model containing a specification, connection diagram and programming example.

This document is updated as new BSL modules are released or for error correction and is distributed with the BSL300 programmer install.

Install And Warnings

About

BSL300 Programmer  is free software used to configure and customise BSL series signal conditioning modules.

- System Requirements: Microsoft Windows XP and above
- Interface Isolation module: BSL303-01

Warning Hazardous Voltages

We are 99.9% sure that if you connect an BSL series module directly to a USB port on your PC or mobile phone no damage either device will occur. Communication will not occur without the BSL303 connected.

The SL devices are isolators. The BSL300 interface connector is in most cases at the negative measurement input potential. This means that connecting to the unit must be via the BSL303. The BSL303 provides 2KV isolation, enabling safe operation while the unit is connected to an operating system.

The BSL series isolators are used in industrial environments, input and or output terminals may be at elevated voltages. Servicing on site should only be conducted by qualified personnel that are familiar with the installation.

Never connect directly between any BSL series module and the USB port on your PC.

Application Package and Driver

The following are supplied from one package (Setup BSL300-yyymm.EXE).

- BSL300 v2 Programmer
- and USB driver (32/64 bit detected)

New versions of the install may be run without uninstalling the old version.

Program Install

1. Run the program package "Setup SL300-yyymm.EXE"

User Account Control

BSL300 Programmer

Verify the publisher and press Yes to start install.

2. The Setup options screen will appear

Select required options select next then install.

General Operation

Program Icons and Function

The user interface is broken up into top bar, bottom bar and client area. The top bar also includes tabs to select between multiple client area programs. The central client area allows data entry and retrieval of program data.

Top and bottom commands

- 

Connect to defined com port and read module settings.
- 

Select the required port and connector module.
- 

Disconnect from COM port
- 

Open disk file into a new tab. Preview module types available or read previously saved settings.
- 

Read settings from connected module into a new tab.

Client Area Commands

- Save to File
Save the currently loaded settings into a disk file

- Program
Write settings into the currently connected module.

- Read
Read settings from connected module into the currently loaded tab. This will overwrite the setting in the current tab.

- Close Tab
Close the program window. Any changes not written into a module or saved to disk file will be lost.



What is the BSL303 and why is it required?

The BSL303 is a USB Isolator that provides galvanic isolation signal and level translation between your BSL series signal conditioning module and your PC.

SL303 connection and "First Contact"

1. Install the BSL300 software package and USB driver software.
2. Connect the supplied cable end A into BSL303 and plug the BSL303 into the USB port on Windows PC. Leave cable end B loose.
3. The windows hardware detection should operate and find hardware USB to serial port. At this stage none of the LED's are on.



4. After hardware detection (slow the first time) connect the loose cable end B into a powered SL series module.

The power supplied by the SL series module will illuminate the green LED on the BSL303.



5. Start the BSL300 software. "All Programs > > BSL300 v2 Programmer" You will find it in the "A section" of the windows 10 start menu. On startup the program attempt connection.

If BSL300 is already running press the connect icon.

If connection is successful basic parameters including part number and serial number will be displayed on the top bar.

Continue with section "Connection Problem" or "Read BSL Module Program".

Connection Problem

Connection problems are caused by failed USB driver install, incorrect com port selected or client BSL module is not powered.

- Click the settings icon

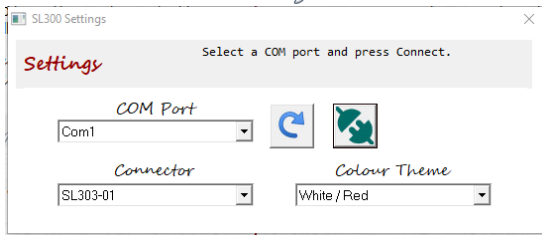

- Check that the "Connector" is set on BSL303-10.
- Click on the com port drop-down and search for connected SL module.

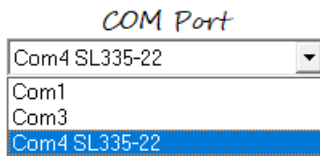

In this example I select COM4.

- After selecting the correct COM port press the connect, parameters should read and the settings dialogue will close automatically.

10. If connection fails the dialogue will remain open and display an error message.

- Check that the SL module is powered.
- Press refresh this will rebuild the COM port list and look for a connected BLS module again.

Read BSL Module Program

The top Bar will now display common module details. The top and bottom bar shows information about the currently selected module regardless of which tab is selected.

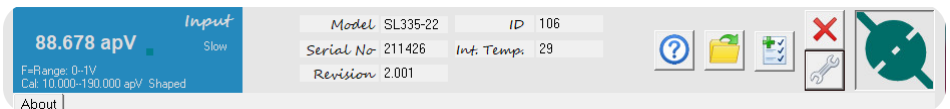

- The top bar click "Read Settings into a new tab".
- This will open a new tab in the central programming area and read program from connected module.

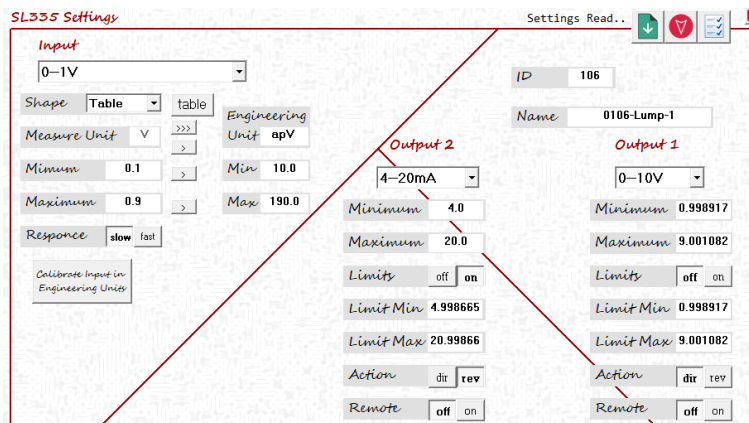

- After reading the program data from a module the existing program data can be saved to disk file.

- Program change are entered into the fields on the central screen. Changes to the name parameter will be reflected in the file name if saved again.

- Press program to write changes into the connected BSL module.

- Pressing read will copy settings from the connected module again any changes you made will be lost tab.

- The close tab button loose any changes not written into a module or saved to disk file.

When programming multiple modules just unplug from the top of the last module and plug into the next. Leave the "A end" of cable connected to the BSL303. The B end will be at the same potential as the reference or zero volts input terminal. In most cases this is quite safe depending on your application if in doubt unplug input connectors.

Common Display Parameters

Model:	Part No of connected item
Serial Number:	Serial of connected item
Revision	Firmware of connected item
Temperature	Temperature of internal processor
ID:	Identification number

Entry Parameters

Range:	Minimum to maximum of measurement unit.
Measurement Unit:	Unit of measure that the range calibration.
Sensor:	External input device producing signal to be measured.
Shape:	Linear Direct relationship between measurement and reading Table A list of correction points applied to correct known errors in the input sensor or system.
Auxiliary:	A power supply available to the input terminals used to power the sensor.
Loading:	Resistance added across measurement terminals to reduce noise or bias inputs.
Response:	Time taken for input measurement to be reflected in the output. The Fast / Slow response function is input filtering to reduce jitter in the measurement.
Engineering Unit:	In many cases it is the same as the measurement unit however the measurement unit can be re scaled into a unit that more closely represents the process being measured.
Engineering Min:	Minimum process value that corresponds to the minimum measured unit value.
Engineering Max:	Maximum process value that corresponds to the maximum measured unit value.
Input Type:	Standard Input is measured between the input and return terminals. Differential Input is the difference between two measured values.
Action: Direct	The output rises from minimum to maximum as the input rises from minimum to maximum.
Action: Reverse	The output falls from maximum to minimum to as the input rises from minimum to maximum.
Signal Limits:	When available HIGH and LOW limits can be set over the entire output signal range. For example: Input: 0 – 100%, Output: 0 – 10V, Low Limit: 2V. High Limit: 8V The input signal will follow in the range of 20% to 80%. Any input below 20% will result in 2V out, any input above 80% will result in 8V out.

Linearisation Tables (Shape)

Standard signal isolators produce a linear input to output response. This means that when plotting output against input on a line chart the result would be a straight line.

The BSL300 software plots input on the vertical axis and output on the horizontal axis.

Many measurement applications require the input output response to be tailored to

correct errors in the measured signal. The BSL series uses industry standard calculations

to create 101 point tables over the measurement range you select when you select a standard probe on the input drop down list.

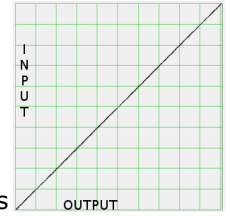

This facility is also available on the generic measurement ranges for you to correct errors in unusual probes or errors in your process parameter measurements. Creating a table for your use you will typically follow a three step process.

- Set Table Scale Input to Output
- Create Table From Ten Known Points
- Edit Individual Points and Plot Between Points

Set Table Scale Input to Output

First create a user specified range to define the input and output of the table.

1. Select the measurement unit.
2. Set the min and max measurement range.
(Measurement = 10 to 400mV)
3. Set the min and max engineering unit and range.
(Engineering = 100 to 1000 Cats)

Later when selecting the output range it should be related to the Cats measurement).

4. Select the shape as Table

If selection is set to linear when you press Program or save your table will be replaced with a straight line.

If you press Read your table will be replaced by the content in the connected module.

5. Click the table button to edit the points.
 - The resulting user table has a horizontal axis is broken up into 101 equally spaced points that represent the engineering output of 100 to 1000 Cats.
 - The vertical axis represents the input value in measurement units.
 - The output point values cannot be changed, the input measurement to produce the output value is changed. Each progressive input value MUST be greater than the last.
6. A user table is usually entered in two steps
 - Create Table From up to Ten Known Points.
 - Edit Individual Points and Plot Between Points.

Create Table From up to Ten Known Points

>>Continued from procedure *Set Table Scale Input to Output*

As the output is divided into 101 evenly spaced points it makes it difficult to enter known correct input and output values as they will seldom be the same as one of the fixed output positions.

The program has a screen to enter up to ten points manually or pasted from a spread sheet.

Only ten rows may be pasted. Output values cannot be duplicated. All values must increase in value.

Ten User Points

In: 10 mV	Out: 100 Cats
50	120
90	280
130	320
180	430
200	500
260	650
270	700
300	800
320	850
360	950
In: 400mV	Out: 1000Cats

1. Open the **Input Table** screen click on **Enter User Points**.
2. Enter the User Input and User Output Values or paste from a spread sheet. Do not include the first and last fixed points in your paste selection.
3. Click **Calculate 101step data**. 101 Input Calculated and 101output calculated data will be generated and plotted on the graph.

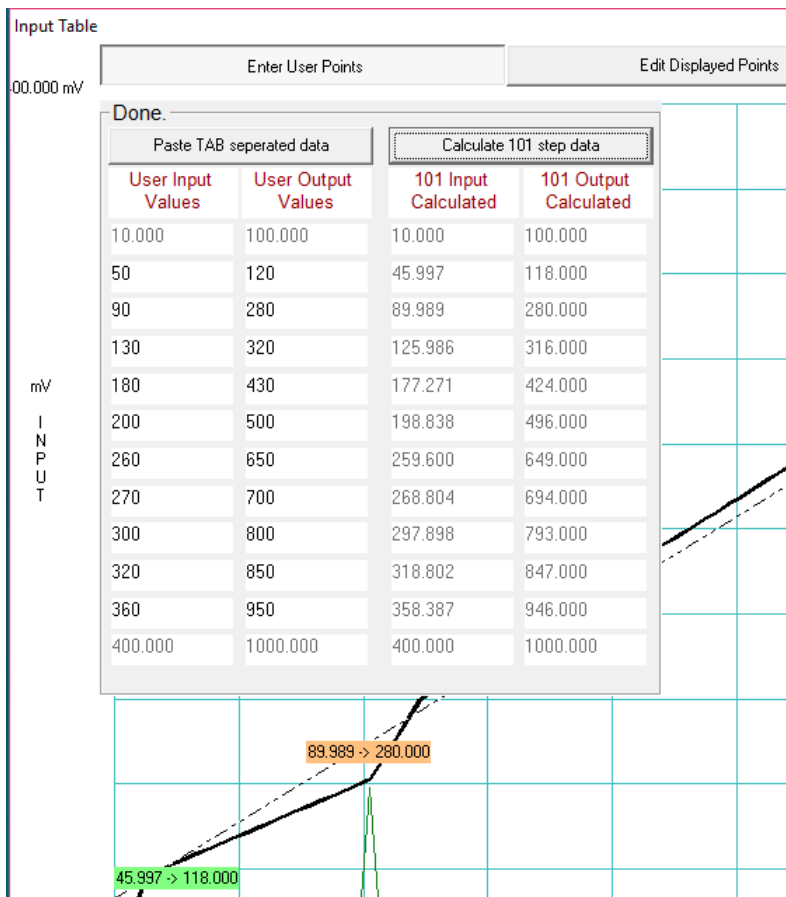

Edit points on next page

Edit Displayed Points

Editing of each input point is accomplished by clicking on the chart or selecting the from the drop down lists. Two drop down lists enable the selection of two points at once which then can then be joined either as a straight line or using the simple bezier function to curve above or below average using the bezier gain slider.

Edit a table example

1. Click on "Edit Displayed Points".
2. Select two points using the two drop down list boxes.

I have selected two points from the drop downs (right image)

Point 1: Input: 216.700 (mV)
Output: 541 (Cats)

Point 2: Input: 271.456 (mV)
Output: 703 (Cats)

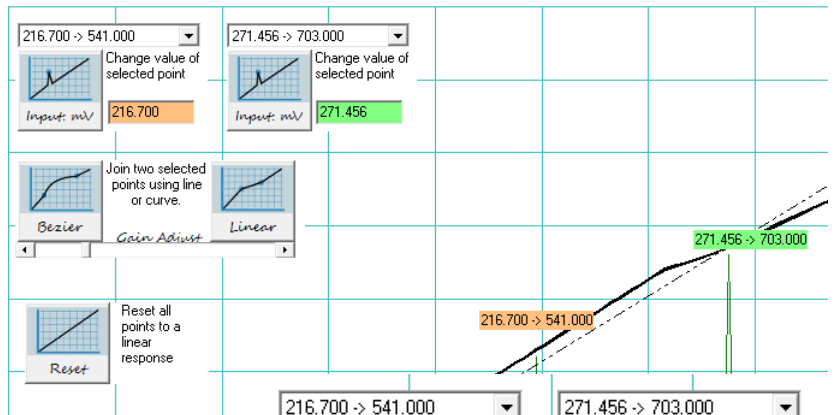

3. Change the input values in associated input boxes.

Point 1: Input: 215 (mV)
Output: 541 (Cats)

Point 2: Input: 290 (mV)
Output: 703 (Cats)

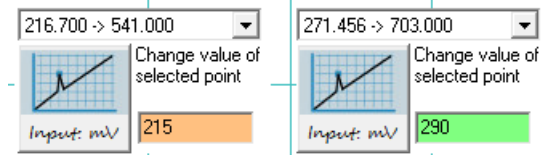

4. After changing the values click the associated update button, values will be written into the point list, updated in the input box and on the chart.

The values will not be exactly the same as what you entered but will be within 0.01% of the original value.

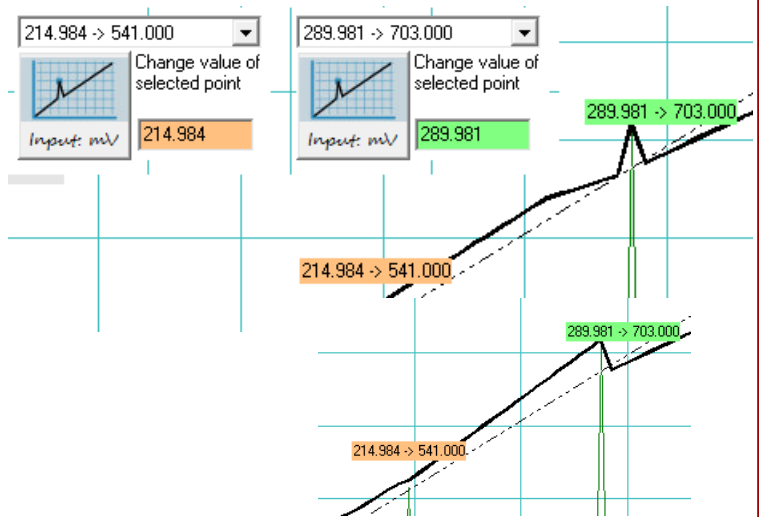

5. With two points still selected I can the press *Linear* join button, the resulting section of curve looks like a saw tooth



6. Leaving the same two points selected pressing the *Bezier* join button a smooth curve can be created with a positive negative shape by adjusting the gain slider

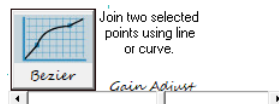

7. It can be seen that all 99 user points can be adjusted by repeating steps 1 to 6 as necessary.

BSL332 Signal Isolator

The BSL332 is a field configurable isolating converter providing true 3-way galvanic isolation up to 2500Vrms for standard process signals. Input and output range are set using two 16 position encoder switches that are accessed under a door flap mounted on the front of the module.

The key features of the BSL332 are;

- Small 12.4mm case size.
- Has a wide range AC/DC power supply.
- 165 factory calibrated input / output ranges.
- Precision digital measurement with digital to analogue conversion after the isolation barrier. This removes all errors associated with the isolation process and ensures faster input to output response.
- All models include an independent user range.
- Two response times.



Order Code BSL332-X X

Supply: _____
 1 = 80-300Vdc / 80-280Vac 50/60Hz
 2 = 10V - 60Vdc / 16 - 42Vac 50/60Hz

Functionality: _____
 0 = Switch Ranges + User Range.
 2 = Switch Ranges + Extended User Range Settings.

General Specifications

Size: 12.4W x 113H x 108D (mm).
 Mounting: Clip for 35mm DIN-Rail.
 Housing material: ABS / Polycarbonate blend
 Connection: Pluggable screw terminals.
 Weight: 85g (including packaging).
 Protection class: IP40.
 Calibration accuracy: <0.1%.
 Linearity: <0.1%.
 Operating temperature: -5...+65°C.
 Temperature drift: 0.01% per °C.
 Load change effect: < 0.05% (current limited to 22mA)
 Response time: LED on = 400ms
 LED off = 25ms.
 Output drive: 10mA into 0 - 2kΩ,
 20mA into 0 - 800Ω.
 Input impedance: 1mA/1kΩ, 10mA/100Ω,
 100mA/36Ω (Term 6).
 Voltage input / > 1MΩ (Term 7).
 Loop power output: 19V / 24mA (Used to power input devices. Term 5)
 Overload continuous:
 Voltage input: 900V MAX.
 Current input: 100mA MAX.
 Noise immunity: 130dB CMRR.
 Input/output isolation: >2.5kVrms.
 EMC: AS/NZS 4251.1 CE EN 50081.1

Select Pre-Calibrated Range

1. Set switch **IP** to desired input.
2. Set switch **OP** to desired output
3. Input and output are now calibrated.
4. Connect to the correct input terminals for your input signal choice (refer to connections on the next page).

About Functionality Options

All BSL332 have 165 user selectable input to output combinations. Also a user specified range can be set using procedure "User Input / Output Button Calibration" on the next page or by using the SL300 programmer.

Modules with "Extended User Range Settings" have additional capabilities when programmed with the BSL300 programmer.

- Input linearisation.
- User engineering units and scaling.
- Reverse and direct acting
- Signal limiting.
- 20 character name.

Input (IP) and Output (OP) Switch Selection

IP	Input	OP	Output
0	Button Cal	0	Button Cal
1	0-1mA	1	0-1mA
2	0-10mA	2	0-10mA
3	0-20mA	3	0-20mA
4	4-20mA	4	4-20mA
5	0-50mA	5	0-1V
6	0-1V	6	0-2V
7	0-2V	7	0-5V
8	0-5V	8	1-5V
9	1-5V	9	0-10V
A	0-10V	A	2-10V
B	2-10V	B	0-20V
C	0-20V	C	
D	0-50V	D	
E	0-100V	E	
F	0-200V User range	F	User range

User Input / Output Button Calibration

This procedure requires test equipment and practical experience in calibration to get the correct result. It only affects the user range when both switches are set on F. All other ranges will retain factory calibration.

The BSL300 programmer may be used to calibrate the user range (without test equipment) instead of the following.

1. Set switches **IP** and **OP** to position 0.
2. Hold down programming button until the slow response LED1 starts to flash and then release.
3. Set switches **IP** and **OP** according to input and output signal requirements.
e.g. Input = 7 to 9mA and Output = 0.3 to 0.9V output, set **IP** to 2 and **OP** to 5.
4. Press the programming button. The slow response LED should flash once to indicate that input and output ranges are remembered.
5. Apply input zero (7mA in this example) and measure output with an external meter.
6. Adjust **OP** switch for zero scale output (0.3V in this example). Use **IP** to switch to set the sensitivity of the **OP** switch, F=course and 0=fine.
7. Press the programming button. The slow response LED should flash twice to indicate that input and output zero scale is remembered.
8. Apply input full scale signal (9mA in this example). Adjust **OP** switch for full scale output (0.9V in this example). Use **IP** to switch to set the sensitivity of the **OP** switch, F=course and 0=fine.
9. Press the programming button. The slow response LED should flash three times to indicate that input and output full scale is remembered.
10. Set switches **IP** and **OP** SW2 to position F and check input output calibration.

If caught half way through a button programming sequence reset the power and start again.

Connection and under door controls

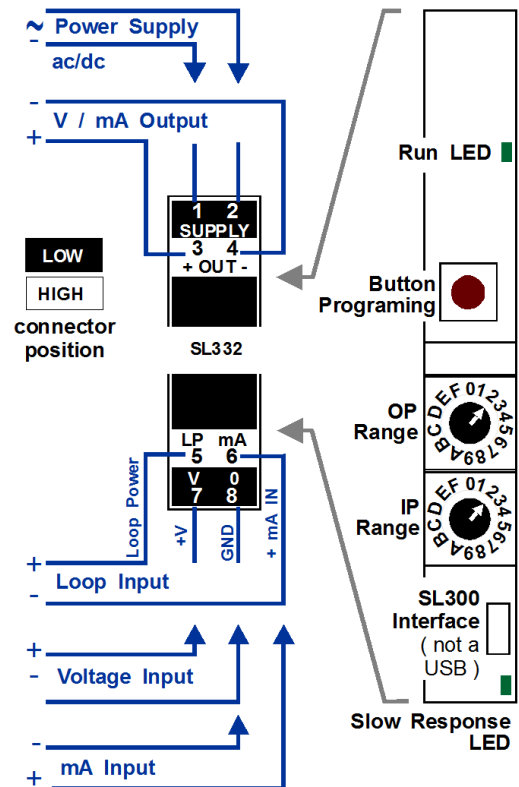

Change Response Time

Use BSL300 programmer or follow this procedure using the switches and buttons.

1. Set switch **IP** to position 0.
2. Set switch **OP** to position 0
3. Hold down, do not release the programming Button.
4. The slow response LED will flash 16 to 20 times before stopping in the new response time state.
5. Release the programming Button.
6. Set switches **IP** and **OP** to the required positions.

In the interest of development and improvement, BASI reserve the right to amend, without notice, details contained in this publication. BASI will accept no legal liability for any errors, omissions or amendments.

Version 0 (BSL332-?) User Range Settings

1. Follow procedure first contact in the general operation section.
2. On the top bar press the *BSL Settings* button. The custom range settings will display in the client area.
3. The current settings may be saved to file if required.
4. Change the input and output parameters as required.
5. The ID may be changed and used for your purposes.
6. Press program to update the user range in the connected device.

Please note that the custom setting apply when the top mounted switches are in the F position.

Version 2 (BSL332-?) Extended User Range Settings

1. Follow procedure "First Contact" in the general section.
2. On the top bar press the *SL Settings* button. The custom range settings will display in the client area.
3. The current settings may be saved to file if required before making any changes.
4. As the input shape or may be adjusted to correct non-linear input applications. See "Linearisation Tables (Shape)" in the "General Section".
5. Change the input and output parameters as required.
6. The ID and name fields are used for identification purposes.
7. Press program to update the user range in the connected device.



BSL335 Signal Splitter

The BSL335 is a field configurable isolating converter/splitter providing true 4-way galvanic isolation up to 1800Vrms for standard process signals. On standard models are 3 x 16 position encoder switches under a door flap to set input and output ranges. All models also have a user range set using the BSL300 configuration software.

- Small 12.4mm case.
- Wide range ac/dc power supply.
- Precision digital measurement and digital to analogue output after the isolation barrier. This removes all errors associated with the isolation process and ensures faster input to output response.
- (When fitted) 1100 input to output range combinations using the three encoder switches mounted under the top door, no re calibration is necessary.
- Models supplied without the range switches are supplied at a reduced cost and provide a higher level of security on range / calibration settings.
- All models include an independent user range.



On models fitted with the "Extended User Range Settings" have the following additional capabilities;

- Input linearisation.
- User engineering units and scaling.
- Reverse and direct acting.
- Signal limiting.
- 20 character name.

Order Code **BSL335-X X**

Supply: _____
 2 = 10V - 60Vdc / 16 - 42Vac 50/60Hz

Functionality: _____
 0 = Switch Ranges + User Range.
 2 = Switch Ranges + Extended User Range Settings.
 3 = Extended User Range (no switches, reduced cost).

General Specifications

Size: 12.4W x 113H x 108D (mm).
 Mounting: Clip for 35mm DIN-Rail.
 Housing material: ABS / Polycarbonate blend
 Connection: Pluggable screw terminals.
 Weight: 85g.
 Protection class: IP40.
 Calibration accuracy: <0.1%.
 Linearity: <0.1%.
 Operating temperature: -5...+65°C.
 Temperature drift: 0.01% per °C.
 Load change effect: < 0.05% (limited to 22mA)
 Response time: 500ms slow/ 25ms fast.
 Output drive: 10mA into 0 - 2kΩ, 20mA into 0 - 800Ω.
 Input impedance: Current input / < 100Ω. Voltage input / > 1MΩ.
 Loop power: 19V / 24mA (Input 4 = 4-20mA loop input)
 Overload continuous:
 Voltage input: 30V MAX.
 Current input: 100mA MAX.
 Noise immunity: 130dB CMRR.
 Input/output isolation: >1.8kVrms.
 EMC: AS/NZS 4251.1 CE EN 50081.1

The user range set using the BSL300 software is in operation when all three switches are in the F position or when no switches are fitted. No test equipment is required when changing ranges.

Switch IP and OP Selections

Range switches are not fitted on all models

IP	Input	OP	Outputs 1 & 2
1	0-10mA	1	0-10mA
2	0-20mA	2	0-20mA
3	4-20mA	3	4-20mA
4	4-20mA LP	4	0-1V
5	0-1V	5	0-2V
6	0-2V	6	0-5V
7	0-5V	7	1-5V
8	1-5V	8	0-10V
9	0-10V	9	2-10V
A	2-10V	A	0-20V
B	0-20V		
F	User range	F	User Range

Connection and Under Door Controls

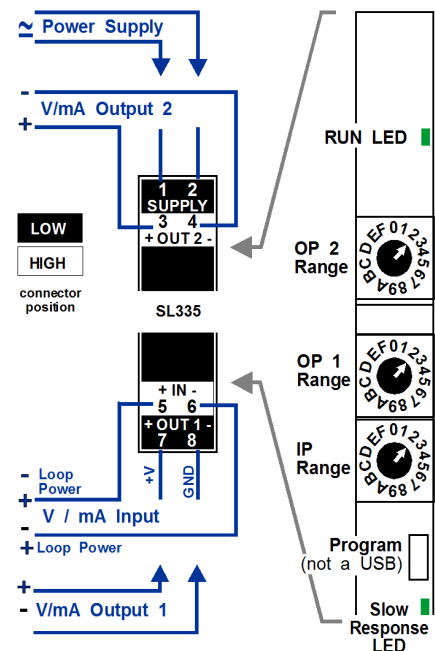

Version 0 (BSL335-20) Custom Range Settings

1. Follow procedure "First Contact" in the general section.
2. On the top bar press the *BSL Settings* button. The custom range settings will display in the client area.
3. The current settings may be saved to file if required.
4. Change the input and output parameters as required.
5. The ID may be changed and used for your purposes.
6. Press program to update the user range in the connected device.

Please note that the custom setting apply when the three top

mounted switches are in the F position.

Version 1 (BSL335-22) Extended User Range Settings

1. Follow procedure "First Contact" in the general section.
2. On the top bar press the *SL Settings* button. The custom range settings will display in the client area.
3. The current settings may be saved to file if required before making any changes.
4. As the input shape or may be adjusted to correct non-linear input applications. See "Linearisation Tables (Shape)" in the "General Section".
5. Change the input and output parameters as required.
6. The ID and name fields are used for identification purposes.
7. Press program to update the user range in the connected device.

BSL339 Signal Isolator

The BSL339 is a software configurable isolating converter providing true 3-way galvanic isolation up to 2500Vrms for standard process signals. The programming socket is under the front door flap. The USB isolator is used with the BSL300 Windows software to display real time input output and calibration parameters.

Key features of the BSL339;

- Small 12.4mm case size.
- Wide range AC/DC power supplies.
- 15 Input ranges and 11 output ranges.
- Precision digital measurement and digital to analogue output after the isolation barrier. This removes all errors associated with the isolation
- process and ensures faster input to output response.
- Input linearisation.
- User engineering units and scaling.
- Supply for power loop input devices.
- Reverse and direct acting output.
- Output signal limiting.
- Input filter for fast or slow response time.



Ordering Detail

Order Code	Supply
BSL339-10	80-300Vdc / 80-280Vac 50/60Hz
BSL339-20	10V - 60Vdc / 16 - 42Vac 50/60Hz

General Specifications

Size:	12.4W x 113H x 108D (mm).
Mounting:	Clip for 35mm DIN-Rail.
Housing material:	ABS / Polycarbonate blend
Connection:	Pluggable screw terminals.
Weight:	85g (including packaging).
Operating temperature:	-5...+65°C.
Temperature drift:	0.01% per °C.
EMC:	AS/NZS 4251.1 CE EN 50081.1
Load change effect:	< 0.05% (current limited to 22mA)
Response time:	LED on = 400mS, LED off = 25mS.
Output ranges:	0-1mA, 0-10mA, 0-20mA, 4-20mA, 0-1V, 0-2V, 0-5V, 1-5V, 0-10V, 2-10V, 0-20V
Output drive:	10mA into 0 - 2kΩ, 20mA into 0 - 800Ω.
Input ranges:	0-1mA, 0-10mA, 0-20mA, 4-20mA, 0-50mA, 0-1V, 0-2V, 0-5V, 1-5V, 0-10V, 2-10V, 0-20V, 0-50V, 0-100V, 0-200V.
Input impedance:	1mA/1kΩ, 10mA/100Ω, 100mA/36Ω (Term 6). Voltage input / > 1MΩ (Term 7).
Loop power supply:	19V / 24mA
Overload continuous:	
Voltage input:	900V MAX.
Current input:	100mA MAX.
Noise immunity:	130dB CMRR.
Input/output isolation:	>2.5kVrms.
Protection class:	IP40.
Calibration accuracy:	<0.1%.
Linearity:	<0.1%.

Connection and Controls

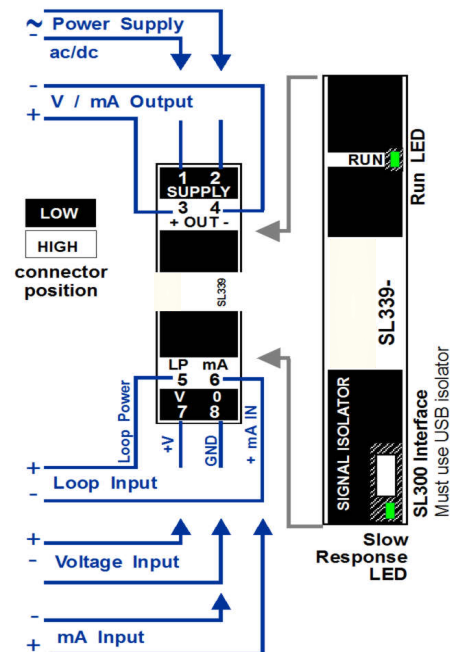

In the interest of development and improvement, BASI reserve the right to amend, without notice, details contained in this publication. BASI will accept no legal liability for any errors, omissions or amendments.

BSL339-?0 Extended User Range Settings

1. Follow procedure "First Contact" in the general section.
2. On the top bar press the *BSL Settings* button. The custom range settings will display in the client area.
3. The current settings may be saved to file if required before making any changes.
4. As the input shape or may be adjusted to correct non-linear input applications. See "Linearisation Tables (Shape)" in the "General Section".
5. Change the input and output parameters as required.
6. The ID and name fields are used for identification purposes.
7. Press program to update the user range in the connected device.

The screenshot shows the 'SL332/SL339 Settings' window. The 'Input' section includes a dropdown menu set to '0-1V', a 'Shape' dropdown set to 'Table', and a 'Measure Unit' dropdown set to 'V'. Below these are 'Minimum' (0.01) and 'Maximum' (0.99) fields with arrows. The 'Response' section has 'slow' and 'fast' options. A button 'Calibrate Input in Engineering Units' is at the bottom left. The 'Engineering Unit' is set to 'wiw7'. The 'Output 1' section includes a dropdown menu set to '1-5V', 'Minimum' (1.0), and 'Maximum' (5.0) fields. There are 'Limits' (off/on), 'Limit Min' (1.0), and 'Limit Max' (5.0) fields. The 'Action' section has 'dir' and 'rev' options. The 'Remote' section has 'off' and 'on' options. The top right shows 'Settings Read..' with a green arrow, a red 'V' icon, and a blue checkmark icon. The 'ID' field is '107' and the 'Name' field is 'DownWiggleLO-AD-RO'.

BSL340 Universal Transmitter

The BSL340 is a field configurable isolating transmitter/converter providing true 3-way galvanic isolation up to 2500Vrms for use with industrial probes and millivolt signals. Input and output are set using the BSL300 programmer connected to a PC USB via the BSL303 interface. Key features of the BSL340 are;

- Small case style.
- Wide range AC/DC power supply.
- Input linearisation.
- User engineering units and scaling.
- Differential and single ended input.
- Switch-able input loading
- Reverse and direct acting
- Signal limiting.
- Programmable sensor supply.
- Switch-able input filter (fast / slow)



Ordering Detail

Order Code	Supply Voltage
BSL340-10	80-300Vdc / 80-280Vac 50/60Hz
BSL340-20	10V-60Vdc / 16-42Vac 50/60Hz

General Specifications

Size:	12.4W x 113H x 108D (mm).
Mounting:	Clip for 35mm DIN-Rail.
Housing material:	ABS / Polycarbonate blend
Connection:	Pluggable screw terminals.
Weight:	85g (including packaging).
Protection class:	IP40.
Input accuracy:	< 0.1%.
Output accuracy:	< 0.1%.
Linearity:	< 0.1%.
Operating temperature:	0...+65°C.
Temperature drift:	0.01% per °C.
Auto input ranges:	Up to ±250mV or 500mV
Overload continuous:	20 x times input range MAX.
Noise immunity:	130dB CMRR.
Input/output isolation:	>2.5kVrms.
EMC:	AS/NZS 4251.1 CE EN 50081.1 , *

Millivolt Input

Minimum input:	-250mV
Maximum input:	624mV
Maximum input range:	500mV
Measurement unit:	mV
Measurement type:	Standard or differential.
Common mode range:	-3V to +6V
Engineering Scale:	minimum, maximum and unit.
Shape:	Linear or 101 user points.
Input impedance:	> 1MΩ.
	switch-able 30kΩ shunt.
Response time:	50mS fast 500mS slow.
AUX supply output:	0.01mA to 10.8mA (3.5V@10mA) 0.1V to 16V 110mA@10V).

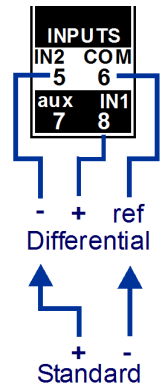

Process Output

Output calibration is entered as minimum and maximum of input engineering range.	
Output can be set as direct or indirect acting. Signal limits can be entered or disabled as required	
Ranges:	1mA, 10mA, 20mA, 1V, 2V, 10mA ii, 2kΩ, ???, 20mA into 0 - 800Ω. ???
Output drive:	
Load change effect:	< 0.05% (current limited to 22mA)

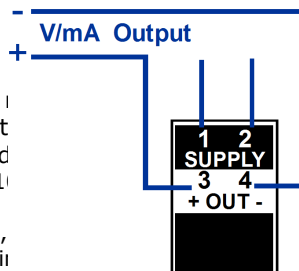

Thermocouple Input

Enter required maximum and minimum in measurement unit, 101 point linearisation is automatically calculated loaded for required range.	
Types:	B, E, J, K, N, R, S
Measurement unit:	°C, °F, °K
Input impedance:	switch-able 30k shunt.
Burn out:	Upscale, Downscale, None Link 5 and 7 for burnout options.
Response time:	50mS fast / 500mS slow

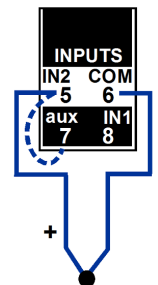

Resistance Transmitter

Minimum span:	1Ω
Maximum span:	50kΩ
Measurement unit:	Ω, kΩ
Measurement type:	2 wire connection.
Engineering Scale:	minimum, maximum and unit
Shape:	Linear or 101 user points
Response time:	50mS fast 500mS slow

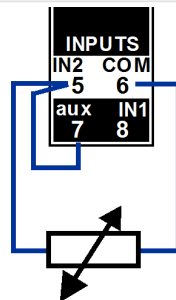

Potentiometer Transmitter

Minimum input:	0%
Maximum input:	100%
Measurement unit:	%Pot
Measurement type:	3 wire connection.
Engineering Scale:	minimum, maximum and unit
Shape:	Linear or 101 user points
Input impedance:	> 1MΩ
Response time:	50mS fast 500mS slow
AUX supply output:	0.5V

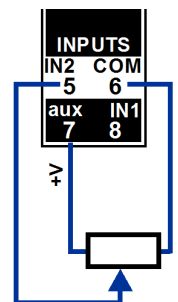

RTD Input

Enter required maximum and minimum in measurement unit, 101 point linearisation is automatically calculated and loaded for required range.

Types: pt100, pt1000

Measurement unit: °C, °F, °K

Response time 2W: 50mS fast / 500mS slow
 3W and 4W: 800mS

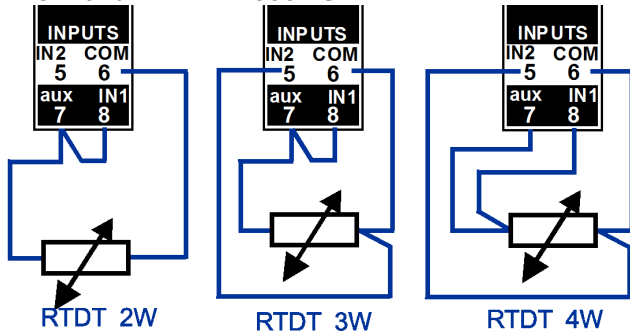

Strain Gauge Transmitter

Measurement unit: mV

Measurement type: Differential.

Common mode range: -3V to +6V

Tare Function: Button under lid.

Engineering Scale: minimum, maximum and unit.

Shape: Linear or 101 user points

Input impedance: > 1MΩ switch-able 30k shunt.

Response time: 50mS fast
500mS slow

AUX supply output: 0.01mA to 10.8mA (3.5V@10mA)
0.1V to 16V (110mA@10V)

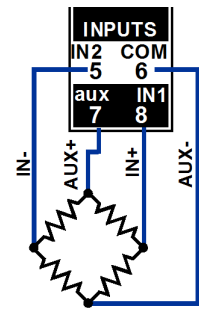

Common Connection and Controls

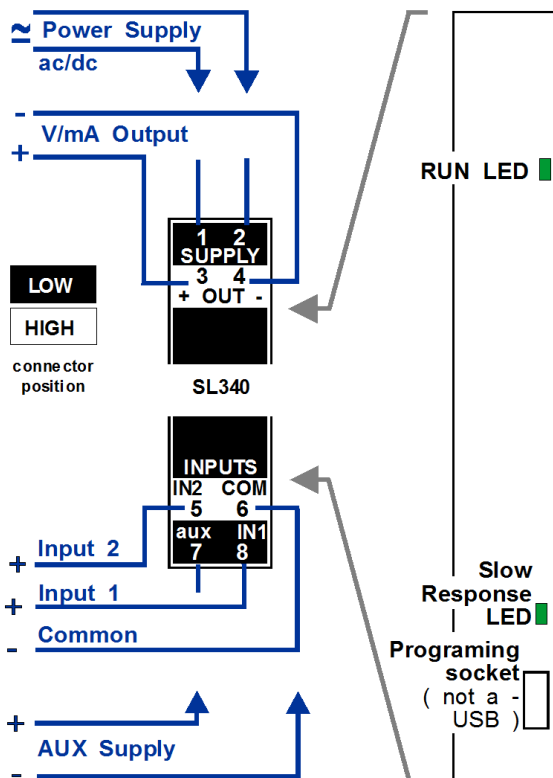

$$Range = \frac{Actual\ Load}{Capacity} \times Sensitivity \times Excitation$$

A load cell of 1000 kg capacity, with 2mV/V sensitivity and 10Vdc excitation has an "actual load" is 500 kg

$$max.,\ then\ Range = \frac{500\ kg}{1000\ kg} \times 2\ mV/V \times 10\ V = 10\ mV$$

The SL340 would be programmed as;

After programming the BSL340 the top mounted tare button MUST be pressed while measurement system is unloaded.

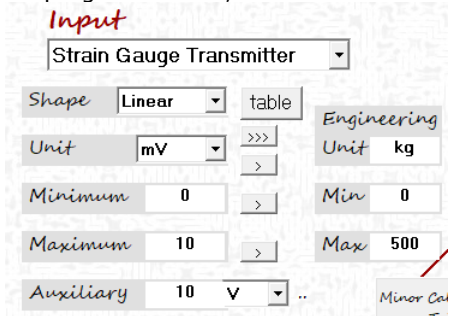

For strain gauge function without using the top mounted tare button use *mV Transmitter* in differential mode.

Display BSL340 Settings

1. Follow procedure "First Contact" in the general section.
2. On the top bar press the *SL Settings* button. The custom range settings will display in the client area.
3. The current settings may be saved to file if required before making any changes.
4. As the input shape is set to table the input output shape found by pressing the table button. See "Linearisation Tables (Shape)" in the "General Section".

5. Change the input drop down setting to change the basic module function required.

Different options will be displayed for each module function.

mV Transmitter parameters displayed.

Input

- mV Transmitter
- mV Transmitter**
- Thermocouple Transmitter
- RTDT 3W Transmitter
- RTDT 4W Transmitter
- RTDT 2W Transmitter
- Resistance 2W Transmitter
- Potentiometer
- Strain Gauge Transmitter

SL340 - Settings Settings Read..

Input

mV Transmitter

Shape

Unit Engineering Unit

Minimum Min

Maximum Max

Auxiliary ..

Loading

Response

In Type

Output

ID

Name

Minimum

Maximum

Limits

Limit Min

Limit Max

Action

Remote

Universal Input - Four Wire Resistance example

The mV input range can solve measurement problems. We have a constant current of constant voltage auxiliary supply along with a linearisation table and standard or differential measurement.

I wish to measure 0 to 10Ω but the resistance input is only a 2 wire connection. This means the measurement is affected by the lead resistance.

If I connect the input using the RTDT 4W connection above I can effectively run two wires to the sensor to supply a constant current and run an additional two wires to the sensor to measure the voltage produced.

I set the auxiliary output to 10mA and the measurement to 100mV differential.

By applying Ohm's law $E = I \times R$ the output will be 0 to 10 ohms.

If the current is too large for your sensor (may cause heating) you could set the auxiliary output to 1mA and the measurement to 10mV differential.

In addition you have the option to add a table to the input to improve linearity if required.

BSL350 Pulse Frequency Transmitter

The BSL350 is a software configurable pulse to process signal converter providing true 3-way galvanic isolation up to 2500Vrms. A variety of pulse signals and sensor types are supported. Input span may be 1 pulse every 5 seconds or frequency of 0 to 150kHz. The measurement may be over a narrow range for a deviation applications e.g. 47 to 53Hz. The AUX sensor supply supports adjustable, current and voltage settings reducing hazards in probe wiring and allowing the use of variable resistance sensors. Final calibration is set using the free BSL300 configuration software, no test equipment is required for accurate calibration. Final adjustment of the trigger level may be performed with the trigger capture button.



Key features of the BSL350;

- Small 12.4mm case size.
- Wide range AC/DC power supplies.
- Crystal based frequency measurement.
- Accurate trigger level setting and run time update.
- No isolation barrier errors.
- Custom input to output linearisation.

BSL300 user software settings

- Input sensor and AUX supply.
- Trigger level setting and capture.
- Input filter.
- Frequency measurement range.
- Input linearisation
- Process output range, limits and action.

General Specifications

Size:	12.4W x 113H x 108D (mm).
Mounting:	Clip for 35mm DIN-Rail.
Housing material:	ABS / Polycarbonate blend
Connection:	Pluggable screw terminals.
Weight:	85g (including packaging).
Operating temperature:	-5...+65°C.
Temperature drift:	0.01% per °C.
EMC:	AS/NZS 4251.1 CE EN 50081.1
Sensor power supply:	0.15 to 15V / 0.2 to 20mA, adjustable
Input/output isolation:	>2.5kVrms.
Protection class:	IP40.
Calibration accuracy:	<0.1%.
Linearity:	<0.1%.
Input span:	0.2Hz to 150kHz (200kHz with gain roll off).
LO Input maximum:	50Vac
LO Input trigger range:	50mV to 6V.
LO Input impedance:	100kΩ/1k5Ω user setting.
LO Gain 1 hysteresis:	60mV on trigger > 0.4V
LO Gain 5 hysteresis:	12mV on trigger < 0.4V
LO Gain 10 hysteresis:	6mV on trigger < 0.2V
HI Input maximum:	260Vac
HI Input trigger range:	8V to 200V.
HI Input impedance:	220kΩ.
HI Gain 1 hysteresis:	8.8V on trigger > 58.8V
HI Gain 5 hysteresis:	1.76V on trigger < 58.8V
HI Gain 10 hysteresis:	0.88V on trigger < 29.4V
Input/Output Response:	70msec to 100msec, see note about response time.
Output ranges:	0-1mA, 0-10mA, 0-20mA, 4-20mA, 0-1V, 0-2V, 0-5V, 1-5V, 0-10V, 2-10V, 0-20V
Output drive:	10mA into 0 - 2kΩ, 20mA into 0 - 800Ω.
Load change effect:	< 0.05% (current limited to 22mA)

WARNING

The trigger capture button and programming socket are at the same potential as terminal 8. This may be at a dangerous elevated voltage depending on your application.

Always use an BSL303 USB Isolator when connecting between your PC and the BSL350.

Ordering Detail

Order Code	Supply
BSL350-20	10V - 60Vdc / 16 - 42Vac 50/60Hz

Response Time

When programming the module you need to specify the frequency range minimum and maximum in measure units (Hz or kHz)

If MAX ≤ 150Hz and the input frequency is < 10Hz then the response is one cycle.

When input is 10Hz response is 100mS

When input is 1Hz response is 1 second.

The three wave forms on the right all have the same period, only the duty cycle has changed. When measuring low speed pulses the BSL350 is measuring period, it is not a pulse counter.

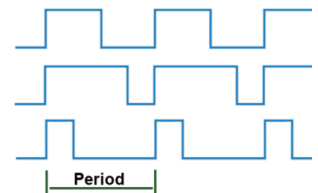

The BSL350 will work on frequencies over the specified 150kHz. This is achieved by using a digital divider on the input signal. The division factor is set from maximum frequency entered during programming.

If the maximum programmed as a very high and the input frequency low long update times are expected in the first 1% of the measurement range.

User Calibration

The BSL350 is configured using the BSL300 software with no compromises on measurement accuracy and speed. The first selection when programming is the input sensor or signal type. Default settings for that type are loaded and user settings continue from that point.

Setting the required function is easy to do however your BASI distributor can program your unit .

Automatic Trigger Update

You can specify the trigger point at time of ordering or programming, however many customers are unsure what the trigger point should be. If the BSL350 is connected to an input pulse/waveform the trigger level may be set using the button located under the top door.

Press and hold the Trigger Button until the **F**unction LED starts flash at a 1/2 second rate. Release the Trigger Button, the **R**un LED will stop flashing while the best input trigger for the input signal is determined.

The updated input trigger and input amplifier gain are permanently stored. When initially programming the trigger function is set to "Trigger Capture" or "Trigger tracking".

Trigger Capture

The stored trigger level input gain is overwritten when top trigger capture button is pressed.

Trigger Tracking

The stored level is overwritten using the same process as Trigger Capture however the pulse valley and peak levels will be continuously monitored. The trigger is continuously set half way between these levels.

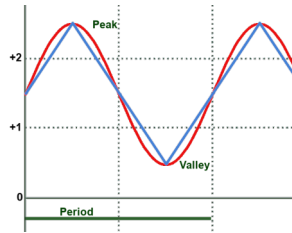

If input pulses derive from magnetic speed sensors the signal is generally sine with an equal positive and negative half (not offset as shown above). The SL350 only measures and triggers on the positive part of an input signal these signals will have a valley equal to 0 and the peak equal to the highest value or $Peak = \sqrt{2} \times V_{RMS}$ for a sine wave).

Input Display Screen (on PC app)

BSL350 measures frequency / period and converts the measurement into a standard process output. The input pulse valley and peak are also continuously measured.

Collected data is displayed on the screen example as follows;

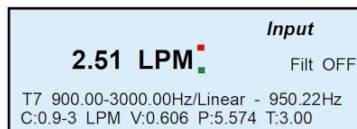

Location	Value	Description
Top left:	2.51 LPM	measured input. engineering units
Second left:	T7 900.00-3000.00 Hz /Linear 950.22Hz	Input terminal. MIN - MAX Measure units Shape. Measurement
Bottom left:	C:0.9-3 LPM V:0.606 (volts). P:5.574 T:3.00	Eng range. Eng units. Valley, input min. Peak, input max (volts). Trigger level (volts).

Connection and Controls

Run LED flashes each time the output updates.

Function LED flashes at the same rate as the input signal plus used during trigger capture.

BSL300 interface socket connects to a PC via an BSL303 USB Isolator. The interface socket is at the same potential a terminal 8.

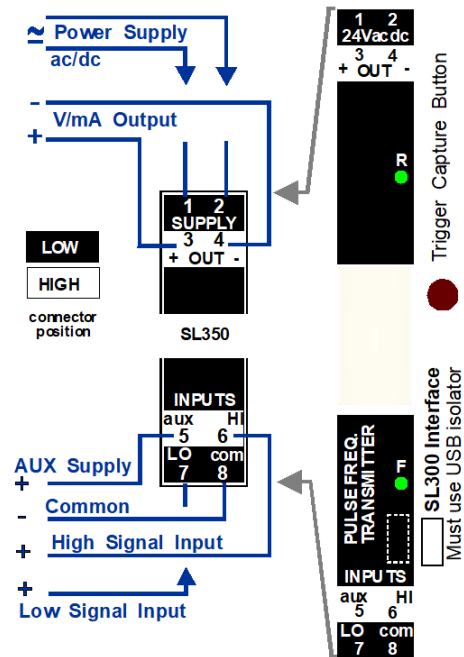

Terminals 1 to 2 power the unit with 2.5kVrms galvanic isolation to other terminals. Check labelling at the terminals for correct supply voltage.

Terminals 3 to 4 are the process signal output with 2.5kVrms galvanic isolation to other terminals.

Terminals 5 to 8 are the input connections with 2.5kVrms galvanic isolation to other terminals.

5kHz Low Pass Filter

Available on all sensor types the low pass filter may be useful in noisy environments. When enabled the rise and fall time is limited to about 100µs in the input amplifier.

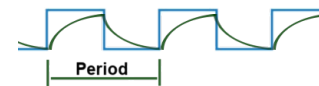

If a 50% duty cycle 5kHz square wave were applied the input amplifier will reproduce a signal looking more like saw teeth removing additional higher frequency noise and reducing amplitude by about 30% at 5kHz.

When using this filter the duty cycle and frequency of the signal must be considered. It is not uncommon for the input pulse to be a fixed ON width and variable OFF width, or a fixed OFF width and variable ON width.

Input and Sensor Settings

The first setting to be made when programming is to set the input sensor or signal type. Default settings for that type are loaded when this setting is changed replacing any existing settings.

NPN 3Wire Sensor

Three wire NPN sensor requires an external 5k6 pull up resistor for the signal into the LO input.

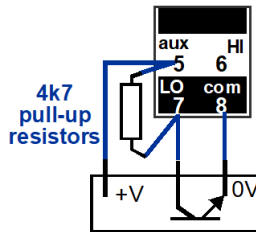

PNP 3 Wire Sensor

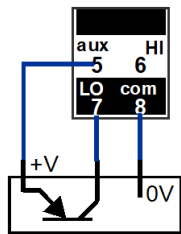

When selecting the NPN sensor the BSL350 connects an internal drop down resistor for the signal load.

NAMUR 2 Wire Loop Powered Sensor

The NAMUR is powered from a series 8.2V supply. When a target is detected current drawn is <1mA. With no target the current is >2.2mA.

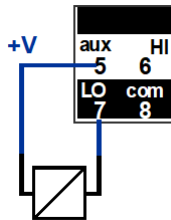

The LO input has an internal 1.5kΩ pull down resistor connected.

2 Wire Output Sensors

Sensors with floating 2 wire output, may be connected with a parallel constant current 4mA supply.

When the sensor is ON the voltage on terminals 7 and 8 is low (0 to 0.7V depending on sensor).

When off the voltage will increase to approximately 6V as the 4mA flows through the internal 1.5kΩ pull down resistor.

This technique has higher noise immunity as 4mA is always flowing through the detection circuits.

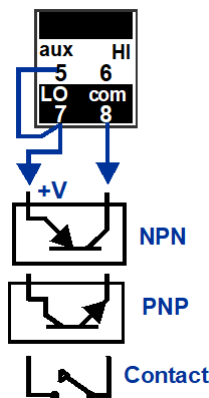

Inductive Speed Sensor

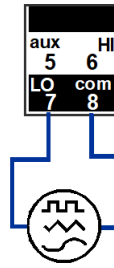

Inductive speed sensors give an increasing frequency and voltage output as ferromagnetic teeth are passed beneath the magnetic sensor. Trigger level is set low to suit detection at low speed.

Any Pulse Trigger 50mV-6V. 50Vac max

LO Input maximum: 50Vac
 LO Input trigger range: 50mV to 6V.
 LO Input impedance: 100kΩ/1k5Ω user setting.
 LO Gain 1 hysteresis: 60mV on trigger > 0.4V
 LO Gain 5 hysteresis: 12mV on trigger < 0.4V
 LO Gain 10 hysteresis: 6mV on trigger < 0.2V

All settings for the LO input are available for use on terminals 5, 7 and 8.

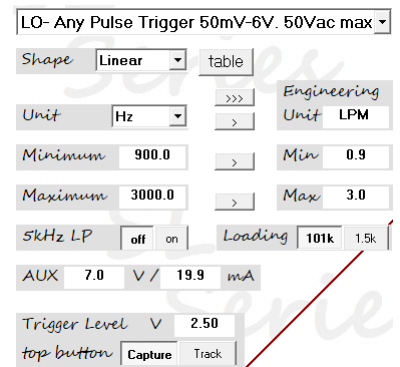

All previously defined sensor connections are supported.

Any Pulse Trigger 8V-260V. 260Vac max

HI Input maximum: 260Vac
 HI Input trigger range: 8V to 200V.
 HI Input impedance: 220kΩ.
 HI Gain 1 hysteresis: 8.8V on trigger > 58.8V
 HI Gain 5 hysteresis: 1.76V on trigger < 58.8V
 HI Gain 10 hysteresis: 0.88V on trigger < 29.4V

When using input terminals 6 and 8 terminals 5 and 7 are normally not required.

If building a mains frequency transducer terminal 8 should be connected to **N** and terminal 9 to the **Active**, the SL350 will operate safely with the leads reversed however the programming socket and trigger capture button located under the front lid will be at active potential.

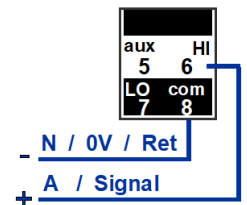

WARNING

The trigger capture button and programming socket are at the same potential as terminal 8. This may be at a dangerous elevated voltage depending on your application.

In the interest of development and improvement, BASI reserve the right to amend, without notice, details contained in this publication. BASI will accept no legal liability for any errors, omissions or amendments.

Table Of Contents

Install And Warnings.....	1
About.....	1
Warning Hazardous Voltages.....	1
Application Package and Driver.....	1
Program Install.....	1
General Operation.....	2
Program Icons and Function.....	2
What is the BSL303 and why is it required?.....	2
BSL303 connection and "First Contact".....	2
Connection Problem.....	3
Read BSL Module Program.....	3
Common Display Parameters.....	4
Entry Parameters.....	4
Linearisation Tables (Shape).....	5
Set Table Scale Input to Output.....	5
Create Table From <i>up to</i> Ten Known Points.....	6
Edit Displayed Points.....	7
Edit a table example.....	7
BSL332 Signal Isolator.....	8
Order Code BSL332-X X.....	8
Supply:.....	8
Functionality:.....	8
General Specifications.....	8
Select Pre-Calibrated Range.....	8
About Functionality Options.....	8
Input (IP) and Output (OP) Switch Selection.....	8
User Input / Output Button Calibration.....	9
Connection and under door controls.....	9
Change Response Time.....	9
Version 0 (BSL332-?0) User Range Settings.....	10
Version 2 (BSL332-?2) Extended User Range Settings.....	10
BSL335 Signal Splitter.....	11
Order Code BSL335-X X.....	11
Supply:.....	11
Functionality:.....	11
General Specifications.....	11
Switch IP and OP Selections.....	11
Connection and Under Door Controls.....	11
Version 0 (BSL335-20) Custom Range Settings.....	12
Version 1 (BSL335-22) Extended User Range Settings.....	12
BSL339 Signal Isolator.....	13
Ordering Detail.....	13
General Specifications.....	13
Connection and Controls.....	13
BSL339-?0 Extended User Range Settings.....	14
BSL340 Universal Transmitter.....	15
Ordering Detail.....	15
General Specifications.....	15
Process Output.....	15
Resistance Transmitter.....	15
Millivolt Input.....	15
Thermocouple Input.....	15
Potentiometer Transmitter.....	15
RTD Input.....	16
Common Connection and Controls.....	16
Strain Gauge Transmitter.....	16
Display BSL340 Settings.....	17
Universal Input - Four Wire Resistance example.....	18
BSL350 Pulse Frequency Transmitter.....	19
General Specifications.....	19
Ordering Detail.....	19



Response Time.....	19
User Calibration.....	19
Automatic Trigger Update.....	20
Trigger Capture.....	20
Trigger Tracking.....	20
Input Display Screen (on PC app).....	20
Connection and Controls.....	20
5kHz Low Pass Filter.....	20
Input and Sensor Settings.....	21
NPN 3Wire Sensor.....	21
PNP 3 Wire Sensor.....	21
NAMUR 2 Wire Loop Powered Sensor.....	21
2 Wire Output Sensors.....	21
Inductive Speed Sensor.....	21
Any Pulse Trigger 50mV-6V. 50Vac max.....	21
Any Pulse Trigger 8V-260V. 260Vac max.....	21
Table Of Contents.....	22