

IO.KAP-03.02(ENG)



# BASI INSTRUMENT AB

MANUFACTURE OF PRESSURE TRANSMITTERS  
AND CONTROL INSTRUMENTS

## USER'S MANUAL





### **FIELD COMMUNICATOR BKAP-03Ex, BKAP-03**

Edition A

SWEDEN JANUARY 2013

BASI Instrument AB., P.O. Box 53, SE-275 06 Vollsjö  
tel. +46 40 88 009 ; fax +46 40 92 98 77  
[www.basi.se](http://www.basi.se) e-mail: [info@basi.se](mailto:info@basi.se)

Symbols used

Symbol	Description
	Warning to proceed strictly in accordance with the information contained in the documentation in order to ensure the safety and full functionality of the device.
	Information particularly useful during installation and operation of the device.
	Information particularly useful during installation and operation of Ex device.
	Information on disposal of used equipment

**BASIC REQUIREMENTS AND SAFE USE**



- **The manufacturer will not be liable for damage resulting from incorrect installation, failure to maintain the device in a suitable technical condition, or use of the device other than for its intended purpose.**
- Installation should be carried out by qualified staff having the required authorizations to install electrical. The installer is responsible for performing the installation in accordance with these instructions and with the electromagnetic compatibility and safety regulations and standards applicable to the type of installation.
- The device should be configured appropriately for the purpose for which it is to be used. Incorrect configuration may cause erroneous functioning, leading to damage to the device or an accident.
- If a device is not functioning correctly, disconnect it and send it for repair to the manufacturer or to a firm authorized by the manufacturer.



- In order to minimize the risk of malfunction and associated risks to staff, the device is not to be installed or used in particularly unfavourable conditions, where the following dangers occur:
- possibility of mechanical impacts, excessive shocks and vibration;
  - excessive temperature fluctuation, exposure to direct sunlight;



Installation of intrinsic safety versions should be performed with particular care, in accordance with the regulations and standards applicable to that type of installation.

Changes in the production of transmitters may precede a paper updating for the user - the current user manuals are available at BASI Instrument AB.

## TABLE OF CONTENTS

1. USE APPLICATION.....	2
2. BASIC FEATURES AND TECHNICAL DATA .....	2
3. LIST OF COMPONENTS .....	3
4. USING KAP-03Ex COMMUNICATOR IN EXPLOSION DANGER ZONES .....	3
5. EXCHANGE OR UPDATING THE COMMUNICATOR'S SOFTWARE BY MEANS OF A PC .....	5
6. CONNECTING AND STARTING THE COMMUNICATOR.....	6
7. FINDING THE TRANSMITTER. ....	6
8. UPDATING DATA. ....	7
9. MAIN MENU .....	7
9.1. INTRODUCTION.....	7
9.2 COMMUNICATOR'S OPTIONS.....	8
<i>I PRESSURE TRANSMITTERS .....</i>	<i>8</i>
9.3. INFO .....	8
9.4 CONFIGURATION.....	9
9.5 CALIBRATION .....	13
9.6 OPERATING LCD.....	15
10.PROCESS VARIABLES .....	16
<i>II TEMPERATURE TRANSMITTERS.....</i>	<i>17</i>
11.1 INFO .....	17
11.2 CONFIGURATION .....	19
11.3 CALIBRATION .....	24
11.4 OPERATING LCD.....	26
12. PROCESS VARIABLES .....	27
FIG.1 KAP-03EX GENERAL VIEW .....	28
FIG.2 COVER OF KAP-03EX COMMUNICATOR .....	29

## 1. USE APPLICATION

The KAP-03 and KAP-03Ex field communicator is a portable device with its own battery power supply, used for communication and exchange of data with intelligent transmitters e. g. pressure, differential pressure, temperature transmitters. It features an output built as a standard current loop 4-20 mA, using FSK modulation type BEL202 with an implemented HART communication protocol revision 5 and revision 6.

The communicator is specially designed to configure intelligent transmitters manufactured by BASI.

The KAP-03 and KAP-03Ex depending on the loaded software can handle one of two groups of BASI transmitters:

- 1) The pressure transmitters, differential pressure transmitters and hydrostatic level probes:  
BDPT-3251, BPT3251, BPT128S,
  
- 2) The temperature transmitters:  
BTT-24, BTT3224ALW.

To change the group of transmitters is necessary to reprogramme of communicator according to the instructions on p. 5

The KAP-03 and KAP-03Ex allows also configuration of the other manufacturers transmitters with the HART protocol version 5 or 6 in the field of standard commands (GENERIC).

### **The communication with the transmitters enables:**

- Identification of a transmitter,
- Configuration of its output parameters:
  - Units and values of the beginning and the end of its measurement range,
  - Ballistic factor,
  - Conversion characteristics (linear, radical, special, quadratic),
- Reading of a currently measured value (e.g. pressure, output current, degree of output setting in %),
- Enforcement of output current with a given value,
- Transmitter calibration as regards master pressure,.
- Zeroing

There is a possibility of upgrade communicator KAP-03 using the application "KAP Loader Setup",

## 2. BASIC FEATURES AND TECHNICAL DATA

- Autonomous power supply from a lithium battery (3.6V / 1.5 Ah).
- Power consumption when active app. 8.5 mA.
- Power consumption when off app. 40 µA.
- Estimated time of constant operation with fully charged battery – app. 7 days.
- Automatic switch off after preprogrammed period of inactivity.
- Communicates displayed on an alphanumeric display 4x20 characters.

- Adjustment of contrast of the displayed characters..
- Plastic film keyboard to input data
- Acoustic signaling of event (e.g. pressed key).
- Communication in BELL202 standard, protocol HART rev5 and rev6 with adaptive adjustment of carrier amplitude.
- Operation with a resistor placed in the transmitter's current loop, with a resistance from 220 to 1100 Ohm.
- Possibility to connect an external power supply (9V stable /200mA) through the charging connector, in order to charge the communicator's battery.
- Battery charge time up to app. 8h for KAP-03 and up to app. 16h for KAP-03Ex
- Possibility to change the communicator's software by means of a "KAP Loader Setup" program using a mini USB connector (USB 1.1 or USB 2.0).
- EMC requirements fulfilled.
- Operating temperature range  $-10^{\circ}\text{C} \leq T_a \leq 50^{\circ}\text{C}$



If communicator was stored in a low temperature, it should be warmed up to the room temperature before switching on.

Available in intrinsic safety version: Communicator designated as KAP-03Ex is designed to be used in explosion danger zones (see point 4).

### 3. LIST OF COMPONENTS

The item consists of the following:

- communicator KAP-03Ex or KAP-03
- cover (for version KAP-03Ex the cover is marked as KAP03AE)
- connection wires with gripping devices
- connection cable USB
- "User's manual"
- Certificate of conformity for KAP-03Ex (certificate for KAP03 at request)

Declaration and ATEX certificates are available at [www.aplisens.pl](http://www.aplisens.pl)

## 4. USING KAP-03Ex COMMUNICATOR IN EXPLOSION DANGER ZONES

### 4.1. Introduction

Communicator in intrinsic safety version is designated as KAP-03Ex.

Communicator in normal version is designated as KAP-03.

Point 4 apply to KAP-03Ex. Other points apply to KAP-03Ex and KAP-03

### 4.2. Use of KAP-03Ex communicator in explosion danger zones

- 4.2.1. KAP-03Ex communicator is produced according to standards:  
EN60079-0:2009, EN60079-11:2012.

4.2.2. KAP-03 Ex communicators may be used in explosion danger zones marked with an anti-explosion structure marking.



II 2G Ex ia IIC T4 Gb  
KDB 07 ATEX 122X

It can also be used under conditions taking into account the following input/output parameters:

$$U_o / U_i = 3,9V / 30VDC$$

$$I_o / I_i = 18,7mA / 0,1A \text{ (liniowy)}$$

$$P_o / P_i = 18,2mW / 1W$$

$$C_i = 26nF (2,2\mu F + 10\% / 220\Omega)$$

$$L_i = 0$$

### 4.3. Identification and warning signs

4.3.1. Communicators in Ex version must feature permanent signs located on their body and cover:

- company logo and device type designation
- CE marking and notified unit number
- antiexplosion structure designation according to point 4.2.2
- Use in the cover KAP03AE only



4.3.2. Additionally, the communicator's body should feature the following:

- serial number and year of production
- output/input parameters
- the following inscription must be located near the power socket:  
„Charge with 9V  $\pm$ 2% only in explosion safe zone”.



### 4.4. Power

The communicator is powered by a lithium-ionic battery with nominal capacity of 1.55Ah and voltage 3.6V.

The battery and its protective elements form a unit covered in polyurethane resin and has the shape of a rectangular cube.

The charging socket is designed to match a concentric plug with an orifice, with its outside diameter of 5.5mm and a bolt  $\varnothing$ 2,5mm.



The charging circuit is protected at its beginning with a tube fuse  $I_n=160mA$   $U_n=250V$ .

The fuse with a frame is placed on the side of the battery and forms its part.

The fuse can be accessed by unscrewing the housing of the communicator, slightly lifting the battery and removing the cover of the fuse socket (Fig.1).

The communicator may be powered only by means of the above described battery set manufactured by BASI.

**The set is replaced in a safe zone by detaching the set from the PCB and unsoldering input wires from the terminals of the charging socket.**



**The set may only be performed by the manufacturer or a unit authorized by the manufacturer.**

### 4.5. Use

4.5.1. KAP-03Ex communicator in Ex version may be used only in the cover supplied together with the communicator with permanently applied designations as per point 4.3.1.



**Information on the method of connecting to the charging and measurement line as well as features and functionalities, the method of setting the unit, taking readouts when the communicator is working together with a converter are specified in the latter part of the User's Manual.**

#### 4.5.2. Charging

The discharged battery is indicated by a blinking battery light on the display.

The battery of KAP-03Ex communicator is charged by connecting a mains charger plug with a coaxial plug with internal connection diameter of 5,5mm and plug orifice Ø2.1mm to the charging socket.

Output voltage of the charger is stabilized and has a nominal value of 9VDC±2%, output current app. 200mA.

Charger output voltage is insulated from the mains with a transformer with reinforced

insulation (designation  ).



The communicator should be charged only in a safe zone. While charging, it is not allowed to connect the communicator's measurement clamps to the signal line leading to the danger zone.

If the battery is fully charged, the communicator may operate for app. 170 hours non stop (7 days).

Charging from the moment the battery is fully discharged until fully charged is app. 16 hours.

#### 4.5.3. No changes, repairs or interventions are allowed in the communicator's electronic system.



The communicator may not be powered by sources of power other than battery set manufactured by BASI.

The damage analysis and repair may only be performed by the manufacturer or a unit authorized by the manufacturer.

**Attention:** Fig.1 KAP-03Ex general view – see page 28,

Fig.2 Cover of KAP-03Ex communicator – see page 29.

## 5. EXCHANGE OR UPDATING THE COMMUNICATOR'S SOFTWARE BY MEANS OF A PC

Software version installed in the communicator can be checked according to p 9.2.2 Manual's.

To replace the software (eg software to handle the pressure transducers on the software for temperature transmitters, or install the latest software version is necessary:

- a) take programme "KAP Loader Setup"
- .b) install it's on PC computer
- c) Start the "KAP Loader Setup" programme on the PC
- d) Connect the Communicator to the PC using USB
- e) put on the Communicator (if the Communicator was on during connecting to the PC it should be switched off and again switched on)

The Communicator confirms each successful connection to the PC by a single beep (while the LCD screen is blank). The "KAP Loader Setup" programme signals successful connection by showing a moving stripe in the lower right corner of the PC display screen. Breaking the communication with the PC (before completing the transmission between "KAP Loader Setup" and the Communicator, e.g. by disconnecting the USB cable) causes that the Communicator leaves the mode of software replacement. Then the procedure should be repeated beginning.

A more detailed description of the exchange of software in KAP-03 and KAP-03Ex is available in "Help" of "KAP Loader Setup".

## 6. CONNECTING AND STARTING THE COMMUNICATOR

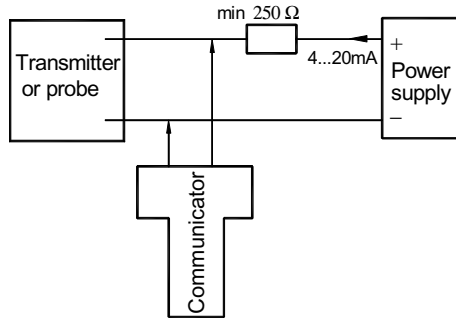

Schematics of connecting KAP-03 communicator to the power and measurement line of the transmitter or probe

Communicator KAP-03 is started by pushing the ON/OFF key.

After switching it on a welcome picture is displayed on the Communicator's screen, showing the producer's name and the Communicator's type.

The line's amplitude is automatically adjusted depending on the line loading that ranges between 250Ω and 1100Ω.

## 7. FINDING THE TRANSMITTER.

During searching for the transmitter the progress bar shows on the Communicator's screen. In the searching time addresses from 0 to 15 are inspected. The procedure is repeated at maximum three times.

If the transmitter possesses address 0 the Communicator will find it, and stop searching. After the search has been finished the address of the found transmitter and its serial number are displayed. Then pushing any key causes change to the mode of updating.

```

FOUND DEVICE
ADDRESS:
ID NR:
> ANY KEY<
  
```

If the transmitter possesses any other address than 0 it is possible to search for other devices after having pushed key F4 [>>>].

```

FOUND DEVICE
ADDRESS:
ID NR:
[ ][ ][ENTER][>>>]
  
```



If the Communicator does not find the transmitter a message appears on the display informing that it is possible to restart it by pushing key F1 [RESTART].

--- NO DEVICE---

CHECK CONNECTION

[RESTART ][ ] [ ] [ ]

## 8. UPDATING DATA.

After the transmitter has been found its data become updated. The progress bar is displayed on the Communicator's screen. After data update the main MENU appears on the screen. The transmission between the Communicator and the transmitter is signalled by the pulsing cursor in the upper left corner of the screen.

## 9. MAIN MENU

### 9.1. INTRODUCTION

9.1.1) The way of moving over the main menu is described by means of the following signs:

- sign [ < ] – means moving to the left along the same MENU level
- sign [ > ] – means moving to the right along the same
- sign [ ↵ ] – means moving to the MENU level below or command confirmation
- sign [ ↑ ] – means moving to the MENU level above.

#### 9.1.2) The Communicator's keys:

- RE – collecting data from the transmitter
- PF – key unavailable
- PV – process variables
- F1, F2, F3, F4 – function keys

#### 9.1.3) Typing in numbers with comma\*

A single short pressing the F1 key [ < ] causes removing one digit before the cursor whereas a longer pressing it results in removing the whole number.

Next figures and point may be typed in by pressing appropriate keys of the keyboard.

After typing in each figure the cursor automatically moves to the next right position.

It is possible to type in maximum 5 figures and the point.

Pressing the F3 key [ ↵ ] acknowledges the typed in value (the cursor vanishes).

#### 9.1.4) Typing in alphanumeric figures \*

Moving on the screen is possible with the use of the F1 key [ < ] and F2 key [ > ]. A given cell may be modified when the pulsing cursor is situated in it. By pressing an appropriate key of the keyboard we may type in alphanumeric figures. Figures are changed by single short or longer key pressing.

Pressing the F3 key [ ↵ ] acknowledges the typed in value (the cursor vanishes).

#### 9.1.5) Typing in integral number \*

A single short pressing the F1 key [ < ] causes removing one digit before the cursor whereas a longer pressing it results in removing the whole number.

Next figures may be typed in by pressing appropriate keys of the keyboard.

After typing in each figure the cursor automatically moves to the next right position.

Pressing the F3 key [ ↵ ] acknowledges the typed in value (the cursor vanishes).

## 9.2 COMMUNICATOR'S OPTIONS.

### 1) Contrast

Contrast adjustment is performed by means of the F2 [ + ] and F1 [ - ] keys.

Pressing the F3 key [ >|< ] causes a return to the factory settings.

Resetting the Communicator does not change performed contrast adjustments.

### 2) Info

In the tag "INFO" incorporates the following information about the Communicator:

- Software version
- The Communicator's electronics version
- Loader's version

### 3) Time to screen saver

The time to screen saver – is a time distance after which the screen saver will be activated. The time to screen saver is presented in minutes.

#### **Time change**

The time may be changed after pressing the F3 key [ ↵ ] and by typing in a value between 0 and 99 (only integers).

Value 0 means that the screen saver shall not be activated.

### 4) Change of calibration code

This function allows to change calibration code.

The original value is: 00000000.

This code should be entered before pressure calibration and current calibration (item 9.5 see page 13).

**Code entering:** see page 10, item 9).

## **I PRESSURE TRANSMITTERS**

### 9.3. INFO

This tab enables viewing the transmitter's parameters and data.

Pressing key F4 [REFRESH] causes renewed taking data from the transmitter.

The [REFRESH] function may also be activated by pressing key RE at any time.

The following parameters are available:

- 1) **IDENTIFICATION NUMBER**
- 2) **MESSAGE** Key F3 [ >>> ] enables scrolling through the whole message.
- 3) **DATUM**
- 4) **TAB LABEL**
- 5) **TAB DESCRIPTION**
- 6) **SERIAL NUMBER**
- 7) **CHARACTERISTIC**
- 8) **UNITS**
- 9) **UPPER LIMIT OF RANGE**
- 10) **LOWER LIMIT OF RANGE**
- 11) **BEGINNING OF ADJUSTABLE RANGE**
- 12) **END OF ADJUSTABLE RANGE**
- 13) **MINIMUM BREADTH OF RANGE**
- 14) **TIME CONSTANT**
- 15) **SAVING LOCK**

- 16) **DEVICE ADDRESS**
- 17) **NUMBER OF PREAMBLES**
- 18) **HEAD NUMBER**
- 19) **ELECTRONICS VERSIONS**
- 20) **PROGRAMME VERSION**
- 21) **TSD**
- 22) **UCS**
- 23) **MANUFACTURER'S CODE OF DEVICE**
- 24) **MANUFACTURER'S CODE OF IDENTIFICATION**
- 25) **DISTRIBUTOR CODE**
- 26) **FLAGS**
- 27) **ERROR FLAGS**

If the value of errors amounts to 0 it means that there were no errors notified during the transmission, and no configuration change took place.

If the value of an error flag is different from 0 then in the upper left corner of the screen an exclamation sign appears.

The errors may be removed by running the "RESET CONFIGURATION FLAG" function which is available at the „CONFIGURATION – TRANSMITTER CONFIGURATION" tab.

After this action the exclamation sign displayed in the upper left corner of the screen vanishes.

## **9.4 CONFIGURATION**

### **9.4.1) CONFIGURING TRANSMITTER**

In this tab it is possible to modify the following parameters of the transmitter:

#### **1) Device address**

This function enables changing the transmitter address in a range from 0 to 15

**Typing in figures** – the process of typing in figures should be performed according to the description in item 9.1.5. It is possible to type in 2 figures.

If a number from beyond the range 0 - 15 is typed in an error message will appear on the screen.

#### **2) Number of preambles**

This function enables changing the number of preambles within a range from 3 to 20.

**Typing in figures** – the process of typing in figures should be performed according to the description in item 9.1.5.

If a number from beyond the range 3 - 20 is typed in an error message will appear on the screen (parameter too small or too large).

#### **3) ID number**

This function enables changing the ID number within a range from 0 to 16777215.

**Typing in figures** – the process of typing in figures should be performed according to the description in item 9.1.5. It is possible to type in 8 figures.

Typing in a number larger than 16777215 is impossible. Such command is not sent to the transmitter and the Communicator goes to a higher menu level.

#### 4) Message

This function enables changing the message text.

**Typing in characters** – the process of typing in characters should be performed according to the description in item 9.1.4. It is possible to type in up to 32 characters.

#### 5) Tag label

This function enables changing the label..

**Typing in characters** – the process of typing in characters should be performed according to the description in item 9.1.4. It is possible to type in up to 8 characters.

#### 6) Tag description

This function enables changing the description.

**Typing in characters** – the process of typing in characters should be performed according to the description in item 9.1.4. It is possible to type in up to 16 characters.

#### 7) Tag date

This function enables changing the date in the following format: XX.XX.XXXX (day, month, year)

**Typing in characters** – the process of typing in characters should be performed according to the description in item 9.1.5 in accordance with the above-presented format.

#### 8) Head number

This function enables changing the head number within a range from 0 to 16777215.

**Typing in characters** – the process of typing in characters should be performed according to the description in item 9.1.5. It is possible to type in up to 8 characters.

Typing in a number larger than 16777215 is impossible. Such command is not sent to the transmitter and the Communicator goes to a higher menu level.

#### 9) Changing the lock code

This function enables changing the lock code.

The lock code consists of 8 characters.

##### Typing in the code

All the characters must be typed in otherwise the Communicator does not accept it and goes to a higher menu level. The following characters may be typed in: 0, 1, 2, 3, 4, 5, 6, 7, 8, 9, A, B, C, D, E, F. Other characters are locked. Each character is typed in by one short pressing an appropriate key. The typed in characters may not be removed, these may only be overwritten. In order to change the code one must fill out the line OLD and the line NEW with eight characters and then acknowledge it by pressing the F3 key [ ↵ ].

-CHANGE PROTECT CODE -

OLD: 1234567█

NEW: 1234567█

[ < ] [ > ] [ ↵ ] [ ↑ ]

The Communicator confirms each correctly performed operation by displaying message „CODE CHANGED”, and pressing the F3 key [ ↵ ] enables its saving. If the lock code is typed in incorrectly the Communicator signals that situation by displaying message „INCORRECT CODE” - then press the F3 key [ ↵ ] to be given a repeated chance of typing in the code.

### 10) Saving lock

This function enables switching on and switching off the saving lock by providing an appropriate code.

**Typing in the code** – according to the description in item 9) page 10.

### 11) Alarm mode

This function enables switching on and off the alarm mode.

The alarm mode is switched on by pressing the F3 key [ ↵ ] and typing in the code of that alarm, which should be activated – in accordance with the description in the following table.

**A full code is a sum of component codes described in the following table.**

<b>CODE</b>	<b>DESCRIPTION</b>
1	Error of a measuring circle break – dynamic signalling 0 – no error, 1- error
2	Errors in the ADC transmitter – static signalling, 0 – no error, 1- error
4	Errors of RAM, EEPROM, PROGRAM - static signalling 0 – no error, 1- error
8	Errors in the local quartz oscillator, processor or transmitter oscillator - static signalling 0 – no error, 1- error
64	Alarm current 0 – high (22 mA), 1 – low (3.6 mA)
128	Current range Mod 0-normal (range 3.9-20.5mA, 1 – NAMUR-Compliant (range 3.8-20.5mA)

**Typing in the alarm code** – the process of typing in characters should be performed according to the description in item 9.1.5. It is possible to type in 3 characters.

### 12) External push-button

This function enables switching on and off the possibility of zeroing and setting the beginning and end of range by delivery of a pressure, by means of magnetised elements (casing AL and ALW) or external push-buttons (casing ALE).

### 13) Resetting configuration flags

This function enables removal of transmission errors.

## 9.4.2) CONFIGURING PV

In this tab it is possible to modify the following parameters of the transmitter:

### 1) Pressure unit

This function enables changing the pressure unit to be used.

Changing to the unit that should be used is performed by choosing the appropriate unit and acknowledging it with the F3 key [ ↵ ]. The F1 [ < ] and F2 [ > ] keys serve for moving between the available units.

#### The following units are available:

- FtH<sub>2</sub>O 68°F
- kPa
- InHg 0°C
- Pa
- InH<sub>2</sub>O 68°F
- kG/cm<sup>2</sup>
- G/cm<sup>2</sup>
- mmH<sub>2</sub>O 4°C
- mbar
- InH<sub>2</sub>O 4°C
- bar
- MPa
- psi
- ATM
- mmHg 0°C
- Torr
- mmH<sub>2</sub>O 68°F
- mH<sub>2</sub>O 4°C

### 2) Beginning of adjustable range

This function enables changing the beginning value of the adjustable range.

The value may be set in the following ways:

- By giving a pressure – a pressure delivered to the transmitter is saved in its memory as the beginning value of the range to be set.
- By typing in a number – the beginning value of the range to be set is typed in with the help of the transmitter's keyboard.

**Typing in a number** – the process of typing in should be performed according to the description in item 9.1.3. It is possible to type in 5 figures and the point.

### 3) End of adjustable range

This function enables changing the end value of the adjustable range. The value may be set in the following ways:

- By giving a pressure – a pressure delivered to the transmitter is saved in its memory as the end value of the range to be set.
- By typing in a number – the end value of the range to be set is typed in with the help of the transmitter's keyboard.

**Typing in a number** – the process of typing in should be performed according to the description in item 9.1.3. It is possible to type in 5 figures and the point.

**4) Characteristic**

This function enables choosing a conversion characteristic for the transmitter. The following kinds of characteristics are available:

- Linear (mx+b)
- Special
- Radical (sqrt(x))
- Third grade radical (sqrt(x^3))
- Fifth grade radical (sqrt(x^5))
- Square (x^2)

**5) Time constant**

This function enables changing the time constant.

**Typing in figures** – the process of typing in should be performed according to the description in item 9.1.3.

It is possible to type in 5 figures and the point. If the typed in number, i.e. time constant value, is larger than 30 seconds it will not be sent to the transmitter and message "TOO LARGE PARAMETER" will be displayed on the transmitter's screen.

**9.5 CALIBRATION**

**1) ZEROING**

The function for zeroing the transmitter is performed in order to eliminate the shift in its characteristic after installing it on a new object. After the ZEROING function has been executed the pressure becomes stabilised and the current pressure is displayed on the Communicator's screen in the form of a number and unit. If the displayed value is appropriate the zeroing operation should be acknowledged by pressing the F3 key [ ↵ ]. The Communicator confirms performance of the zeroing by displaying the following message: „FIRST PROCESS VARIABLE ZEROED (PV)“.

**2) PRESSURE CALIBRATION**

Before calibration ought to be enter calibration code: 00000000.

Change of calibration code: see item 9.2 options of communicator page no. 8

This function enables calibrating the upper and the lower value of pressure.

The to be calibrated is chosen by pressing the key F1 [ < ] or the F2 key [ > ] and acknowledged by pressing the F3 key [ ↵ ].

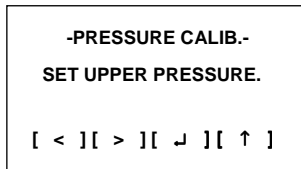
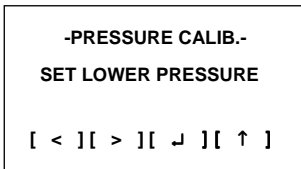

After choosing the pressure to be calibrated (the upper or the lower one) the pressure becomes stabilised and the current pressure is displayed on the Communicator's screen in the form of number and unit. When the chosen pressure is displayed it should be acknowledged by pressing the F3 key [ ↵ ] and the master pressure value should be typed in.

**Typing in figures** – according to the description in item 9.1.3.

After carrying out calibration operation the Communicator displays message „CALIBRATION SUCCESSFULLY EXECUTED”.

```

- WAIT UNTIL-
STAB. OF PRESSURE
XXXXXX  XXX
[ ] [ ] [ ↓ ] [ ↑ ]

```

```

WRITE PATTERN
PRESSURE VALUE
XXXXX■  XXX
[ < ] [ > ] [ ↓ ] [ ↑ ]

```

```

-PRESSURE CALIB.-
FINISHED SUCCESSFULL
[ ] [ ] [ ] [ OK ]

```

The values of assumed calibration points do not have to be equal to the upper and bottom limits of the basic range but these may not go beyond them, i.e. be higher and lower respectively. The breadth of the calibration range may not be smaller than the minimum breadth of set range. In order to reach the best possible accuracy it is recommended that the calibration points and the beginning and end points of the set range have the same or near values.

### 3) CURRENT CALIBRATION

Before calibration ought to be enter calibration code: 00000000.

Change of calibration code: see item 9.2. options of communicator page no. 8

#### a) The upper or bottom limit of range

```

- CALIB. OF CURRENT -
SET I (- - -)
X.XXXX■  mA
[ < ] [ > ] [ ↓ ] [ ↑ ]

```

```

READ CURRENT
FROM AMPEROMETER
AND WRITE IT
[ ] [ ] [ ] [ OK ]

```

```

- CALIB. OF CURRENT -
CALIB. I (- - -)
X.XXXX■  mA
[ < ] [ > ] [ ↓ ] [ ↑ ]

```

The Communicator confirms performance of the calibration by displaying message: „CURRENT CALIBRATION SUCCESSFULLY EXECUTED”

#### b) Setting a current of 4 mA or 20 mA

```

CURRENT LOOP
SET:
4mA
[ ] [ ] [ ] [ OK ]

```

```

READ CURRENT
FROM AMPEROMETER
AND WRITE IT
[ ] [ ] [ ] [ OK ]

```

```

- CALIB. OF CURRENT -
CALIB. I (- - -)
X.XXXX■  mA
[ < ] [ > ] [ ↓ ] [ ↑ ]

```

The Communicator confirms performance of the calibration by displaying message „CURRENT CALIBRATION SUCCESSFULLY EXECUTED”

### 2) RESETTING THE ORIGINAL VALUES

This function enables return to the settings that have been done at the production stage of the transmitter:

- Zeroing
- Pressure calibration
- Current calibration



## 9.6 OPERATING LCD.

This function is available only for the transmitters equipped with an LCD display.

### 1) SWITCHING ON / OFF LCD.

This function enables switching on and off the LCD display.

### 2) REVERSE

This function enables displaying values on the transmitter's LCD display in the reverse form.

### 3) TURN

This function enables turning the values displayed on the LCD display by 180°.

After executing this function the message about restarting is displayed.

The effect of the turning of the displaying is visible after the restarting.

### 4) PROCESS VARIABLES

This function enables displaying an appropriate process variable on the LCD screen of the transmitter.

It is possible to display values of current, pressure, range percentage or user's range.

### 5) COMMA

This function enables setting a comma in any position of the number displayed on the transmitter's LCD screen.

### 6) CONTRAST

Contrast adjustment is performed by means of the F2 [ + ] and F1 [ - ] keys.

Pressing the F3 key [ >|< ] causes a return to the in-factory pre-set settings.

Resetting the Communicator does not change performed contrast adjustments.

### 7) USER'S RANGE

#### a) User's units

This function enables changing units in which the values are displayed on the transmitter's LCD screen. After displaying the current user unit and pressing the F3 key [ ↵ ] units may be changed.

**Typing in characters and figures** - according to the description in item 9.1.4

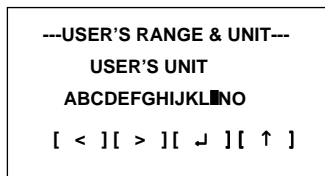

#### b) Beginning of range

This function enables changing the beginning value of the range, which is displayed on the transmitter's LCD screen. The current value is displayed on the screen. The F3 key [ ↵ ] enables modification of the value.

**Typing in figures** – according to the description in item 9.1.3.

**c) End of range**

This function enables changing the end value of the range, which is displayed on the transmitter's LCD screen. The current value is displayed on the screen.

The F3 key [  $\downarrow$  ] enables modification of the value.

**Typing in figures** – according to the description in item 9.1.3.

**8) LOCK FOR THE LOCAL SETTINGS**

This function enables switching on or off the lock for the local settings.

The current status is signalled by displaying one of the following two messages: ON, OFF.

The status may be changed by means of the F3 key [  $\downarrow$  ].

**10. PROCESS VARIABLES**

This function is available after pressing the PV key on the Communicator. It enables current viewing the following process variables:

- FIRST PROCESS VARIABLE PV
- SECOND PROCESS VARIABLE SV
- THIRD PROCESS VARIABLE TV
- FOURTH PROCESS VARIABLE FV
- RANGE PERCENTAGE
- CURRENT (mA)

The information is refreshed every 0.9 seconds. Moving between the available variables is possible by means of the F1 [ < ] and F2 [ > ] keys.

## **II TEMPERATURE TRANSMITTERS**

### **11.1 INFO**

This tab enables viewing the transmitter's parameters and data..

Pressing key F4 [REFRESH] causes renewed taking data from the transmitter.

The [REFRESH] function may also be activated by pressing key RE at any time.

The following parameters are available:

- 1) **IDENTIFICATION NUMBER**
- 2) **MESSAGE Key F3 [>>>] enables scrolling through the whole message.**
- 3) **DATUM**
- 4) **TAB LABEL**
- 5) **TAB DESCRIPTION**
- 6) **SERIAL NUMBER**
- 7) **CHARACTERISTIC – processing the percentage of range on current**
- 8) **UNITS**
- 9) **UPPER LIMIT OF RANGE**
- 10) **LOWER LIMIT OF RANGE**
- 11) **UPPER LIMIT OF TEMPERATURE - range of temperature compensation**
- 12) **LOWER LIMIT OF TEMPERATURE - range of temperature compensation**
- 13) **BEGINNING OF ADJUSTABLE RANGE**
- 14) **END OF ADJUSTABLE RANGE**
- 15) **MINIMUM BREADTH OF RANGE**
- 16) **TIME CONSTANT**
- 17) **SAVING LOCK**
- 18) **DEVICE ADDRESS**
- 19) **NUMBER OF PREAMBLES**
- 20) **SENSOR NUMBER**
- 21) **ELECTRONICS VERSIONS**
- 22) **PROGRAMME VERSION**
- 23) **TSD – transmitter-specific cmd revision**
- 24) **UCS – universal command revision**
- 25) **MANUFACTURER'S CODE OF DEVICE**
- 26) **MANUFACTURER'S CODE OF IDENTIFICATION**
- 27) **DISTRIBUTOR CODE**
- 28) **FLAGS**
- 29) **ERROR FLAGS**

If the value of errors amounts to 0 it means that there were no errors notified during the transmission, and no configuration change took place.

If the value of an error flag is different from 0 then in the upper left corner of the screen an exclamation sign appears.

The error flags may be removed by running the "RESET CONFIGURATION FLAG" function which is available at the „CONFIGURATION – TRANSMITTER CONFIGURATION" tab.

After this action the exclamation sign displayed in the upper left corner of the screen vanishes.

**30) STATUSES OF VARIABLES**

- a) **PV STATUS** – status of first process variable.
- b) **SV STATUS** – status of second process variable
- c) **TV STATUS** – status of third process variable.
- d) **CURRENT STATUS** – current status

**31) STATUS OF TRANSMITTER**

The displayed value is the sum of the statuses values.

<i>Value</i>	<i>NAME OF NOTIFIED STATUS.</i>
1	RAM_TEST_ERROR
2	FLASH_CRC_ERROR
4	BAD_CRC_IN_SEGMENT_INFO
8	OSCILLATOR_FAULT
16	HT430_INIT_ERROR
32	ADC_INTERFACE_MASTER_ERROR
64	ADC_INTERFACE_SLAVE_ERROR
128	ADC_RESPOND_TIMEOUT
256	SENSOR_FAILURE
512	SENSOR_NOT_CONNECTED
1024	PRIMARY_VARIABLE_NOT_VALID
2048	PRIMARY_VARIABLE_OUT_OF_LIMITS
4096	SECONDARY_VARIABLE_OUT_OF_LIMITS
8192	ANALOG_OUTPUT_SATURATED
16384	OUTPUT_CURRENT_FIXED
32768	HOT_START_OCCURE

**32) RANGE OF CURRENT****33) ALARM CURRENT**

**34) ALARM MASK** - Alarm mask table is described in the configuration of the transmitter input.

**35) RANGE OF INPUT****36) TYPE OF LINEARISATION**

**37) COMPENSATION OF COLD JUNCTIONS** - applies to thermoelements only.

**38) TYPE OF CONNECTION****39) PV VALUE****40) DEVIATION OF CHANNEL 1****41) DEVIATION OF CHANNEL 2**

**42) RESISTANCE OF WIRES CHANNEL 1** - applies to sensors res. only.

**43) RESISTANCE OF WIRES CHANNEL 2** - applies to sensors res. only.

**44) CONSTANT TEMPERATURE OF COLD JUNCTIONS**-applies to thermoelements only.

## 11.2 CONFIGURATION

### 11.2.1) CONFIGURING TRANSMITTER

In this tab it is possible to modify the following parameters of the transmitter:

#### 1) Device address

This function enables changing the transmitter address in a range from 0 to 15. Addresses from 1 to 15 are designed for mode **multidrop**.

**Typing in figures** – the process of typing in figures should be performed according to the description in item 9.1.5. It is possible to type in 2 figures. After typing in each figure the cursor automatically changes its position for the next one. It is possible to type in for example figure 2 instead of 02 without fear – both forms are accepted by the device.

If a number from beyond the range 0 - 15 is typed in an error message will appear on the screen.

#### 2) Number of preambles

This function enables changing the number of preambles within a range from 3 to 20.

**Typing in figures** – the process of typing in figures should be performed according to the description in item 9.1.5.

If a number from beyond the range 3 - 20 is typed in an error message will appear on the screen (parameter too small or too large).

#### 3) ID number

This function enables changing the ID number within a range from 0 to 16777215.

**Typing in figures** – the process of typing in figures should be performed according to the description in item 9.1.5. It is possible to type in 8 figures.

Typing in a number larger than 16777215 is possible. Such command is not sent to the transmitter and the Communicator goes to a higher menu level.

#### 4) Message

This function enables changing the message text.

**Typing in characters** – the process of typing in characters should be performed according to the description in item 9.1.4. It is possible to type in up to 32 characters.

#### 5) Tag label

This function enables changing the label.

**Typing in characters** – the process of typing in characters should be performed according to the description in item 9.1.4. It is possible to type in up to 8 characters.

#### 6) Tag description

This function enables changing the description.

**Typing in characters** – the process of typing in characters should be performed according to the description in item 9.1.4. It is possible to type in up to 16 characters.

#### 7) Tag date

This function enables changing the date in the following format: XX.XX.XXXX (day, month, year).

**Typing in characters** – the process of typing in characters should be performed according to the description in item 9.1.5 in accordance with the above-presented format.

## 8) Sensor number

This function enables changing the sensor number within a range from 0 to 16777215.

**Typing in characters** – the process of typing in characters should be performed according to the description in item 9.1.5. It is possible to type in up to 8 characters.

Typing in a number larger than 16777215 is impossible. Such command is not sent to the transmitter and the Communicator goes to a higher menu level.

## 9) Changing the lock code

This function enables changing the lock code.

The lock code consists of 8 characters and is written in code HEX (0...9 ABCDEF).

### Typing in the code

All the characters must be typed in otherwise the Communicator does not accept it and goes to a higher menu level. The following characters may be typed in: 0, 1, 2, 3, 4, 5, 6, 7, 8, 9, A, B, C, D, E, F. Other characters are locked. Each character is typed in by one short pressing an appropriate key. The typed in characters may not be removed, these may only be overwritten. In order to change the code one must fill out the line OLD and the line NEW with eight characters and then acknowledge it by pressing the F3 key [ ↵ ].

```
-CHANGE PROTECT CODE-  
OLD: 1234567█  
NEW: 1234567█  
[ < ] [ > ] [ ↵ ] [ ↑ ]
```

The Communicator confirms each correctly performed operation by displaying message „CODE CHANGED”. If the lock code is typed in incorrectly the Communicator signals that situation by displaying message „INCORRECT CODE” - then press the F3 key [ ↵ ] to be given a repeated chance of typing in the code.

## 10) Saving lock

This function enables switching on and switching off the saving lock by providing an appropriate code.

**Typing in the code** – according to the description in item 9) page 20.

## 11) Resetting configuration flags

This function enables removal of flag of configuration change.

## 11.2.2) CONFIGURING PV

In this tab it is possible to modify the following parameters of the transmitter:

### 1) Temperature unit

This function enables changing the temperature unit to be used.

Changing to the unit that should be used is performed by choosing the appropriate unit and acknowledging it with the F3 key [ ↵ ]. The F1 [ < ] and F2 [ > ] keys serve for moving between the available units.

Depending on the type of transmitter the following units can be available :

- °C
- K
- °F
- °Rk
- mV
- V
- ohm
- kohm

### 2) Beginning of adjustable range

This function enables changing the beginning value of the adjustable range.

**Typing in a number** – the process of typing in should be performed according to the description in item 9.1.3. It is possible to type in 5 figures and the point.

### 3) End of adjustable range

This function enables changing the end value of the adjustable range.

**Typing in a number** – the process of typing in should be performed according to the description in item 9.1.3. It is possible to type in 5 figures and the point.

### 4) Time constant

This function enables changing the time constant.

**Typing in figures** – the process of typing in should be performed according to the description in item 9.1.3.

It is possible to type in 5 figures and the point. If the typed in number, i.e. time constant value, is larger than 30 seconds it will not be sent to the transmitter and message "TOO LARGE PARAMETER" will be displayed on the transmitter's screen.

### 5) Value PV

Function enables mathematical enumerating for process variable:

- a) CHANNEL 1
- b) CHANNEL 2
- c) CHANNEL 1 – CHANNEL 2
- d) CHANNEL 2 – CHANNEL 1
- e) MAX. (CHANNEL 1; CHANNEL 2)
- f) MIN. (CHANNEL 1; CHANNEL 2)
- g) AVER. (CHANNEL 1; CHANNEL 2) – The arithmetic mean of the two channels.
- h) AV2. (CHANNEL 1; CHANNEL 2) – The average value of the two channels either value of channel 1 or 2, if the latter (2) has a status different from the (1).

### 11.2.3) CONFIGURING INPUT SIGNAL OF TRANSMITTER

#### 1) type of connection.

Function makes possible the change of connecting type to transmitter sensor:

- a) 2 WIRE.
- b) 3 WIRE.
- c) 4 WIRE.
- d) 2 SENSORS 2 WIRE.
- e) 2 SENSORS 3 WIRE.

#### 2) The resistance of wires of channel 1.

Function allows to enter a values of resistance to the channel 1

**Typing in figures** – according to the description in item 9.1.3

#### 3) The resistance of wires of channel 2.

Function allows to enter a values of resistance to the channel 2

**Typing in figures** – according to the description in item 9.1.3

#### 4) Range of input.

Function allows to change the range:

- a) -10 – 100 mV (recommended for thermoelement)
- b) -10 – 1000 mV
- c) 0 – 400  $\Omega$  (recommended for PT100)
- d) 0 – 2000  $\Omega$

#### 5) Type of linearisation.

This function enables changing the type of linearisation

- a) WITHOUT LINEARISATION.
- b) INPUT TABLE (the edition of table is described in item 11.2.3.10)
- c) Pt10 a=0.003850                      l) TC TYPE B
- d) Pt50 a=0.003850                      m) TC TYPE E
- e) Pt98 a=0.003923                      n) TC TYPE J
- f) Pt100 a=0.003850                      o) TC TYPE K
- g) Pt100 a=0.003916                      p) TC TYPE N
- h) Pt500 a=0.003850                      r) TC TYPE R
- i) PT1000 a=0.003850                      s) TC TYPE S
- j) Ni100 W100=1.617                      t) TC TYPE T
- k) Cu100 W100=1.426

#### 6) Deviation of channel 1.

Function adds algebraically, the deviation for the process variable for channel 1

**Typing in figures** – according to the description in item 9.1.3

#### 7) Deviation of channel 2

Function adds algebraically, the deviation for the process variable for channel 2

Typing in figures – **according to the description in item 9.1.3.**

#### 8) Cold Junctions Compensation:

- a) WITHOUT COMPENSATION
- b) TEMPERATURE MEASUREMENT OF COLD JUNCTIONS.
- c) CONSTANT TEMPERATURE OF COLD JUNCTIONS.

#### 9) Constant temperature of cold junctions

Function has the ability to change the temperature of cold junctions.

Typing in figures – **according to the description in item 9.1.3**

#### 10) Input array.

Function allows to introduce the user array. You can write to the array to 60 points.

Typing in figures – **according to the description in item 9.1.3.**



<b>--INPUT ARRAY--</b> <b>NR OF POINTS : X</b> <b>STATUS: XXXXXX</b> <b>[ RST ][ ] [ ↓ ] [ ↑ ]</b>	<b>POINT: X OF X</b> <b>IN: mV/ohm</b> <b>OUT: mV/ohm/C</b> <b>[ ] [ ] [ OPE ] [ ↑ ]</b>	<b>POINT: X OF X</b> <b>IN: mV/ohm</b> <b>OUT: mV/ohm/C</b> <b>[ DEL ] [ INS ] [ EDT ] [ ↑ ]</b> <b>_</b>
-------------------------------------------------------------------------------------------------------------	---------------------------------------------------------------------------------------------------	-----------------------------------------------------------------------------------------------------------------------

[RST] – reset of user's table  
 [OPE] – operations on a given point  
 [EDT] – modification of a point in the array  
 [DEL] – deleting of a point from an array  
 [INS] – insertion of a point to the array

<b>----- EDIT POINT -----</b> <b>IN: X.XXXX mV/ohm</b> <b>OUT: X.XXXX mV/ohm/C</b> <b>[ &lt; ] [ &gt; ] [ ↓ ] [ ↑ ]</b>
----------------------------------------------------------------------------------------------------------------------------------

## 11.2.4) TRANSMITTER OUTPUT CONFIGURATION

### 1) Range of current.

Function allows a selection of a suitable current range:

- a) NORMAL (3.9 – 20.8) mA.
- b) NAMUR (3.8 – 20.5) mA.

### 2) Alarm current.

This function enables choosing a alarm current:

- a) LOW
- b) HIGH
- c) USER'S –possibility of entry of self-worth.

Typing in figures – **according to the description in item 9.1.3.**

- d) LAST VALUE.

### 3) Characteristic (processing on current of the percentage range)

- a) Linear (mx+b)
- b) Special
- c) Radical (sqrt(x))
- d) Third grade radical (sqrt(x^3))
- e) Fifth grade radical (sqrt(x^5))
- f) Outputs table
- g) Square (x^2)

#### 4) Mask alarms.

<b>Value</b>	<b>Name of displayed error:</b>
1	RAM memory error
2	CRC programme error
4	Error of CRC data memory
8	Oscillator error
16	HART modem error
32	Transmitter error of galvanic barrier
64	Error from primary side of galvanic barrier
128	Error from secondary side of galvanic barrier
256	Sensor error
512	Disconnected sensor
1024	PV inappropriate
2048	PV outside the limits
4096	SV outside the limits

Entered value should be the sum of the individual active alarms.  
Typing in figures – **according to the description in item 9.1.5.**

### 11.3 CALIBRATION

Before calibration ought to be enter calibration code: 00000000.

Change of calibration code: see item 9.2 options of communicator page no. 8

This function enables calibrating the upper and the lower value of temperature.

The to be calibrated is chosen by pressing the key F1 [ < ] or the F2 key [ > ] and acknowledged by pressing the F3 key [ ↵ ].

#### 1) CURRENT CALIBRATION

Setting a current of 4 mA or 20 mA

<b>CURRENT LOOP</b> <b>SET:</b> <b>4mA</b> [ ] [ ] [ ] [ ] [ OK ]
----------------------------------------------------------------------------

<b>READ CURRENT</b> <b>FROM AMPEROMETER</b> <b>AND WRITE IT</b> [ ] [ ] [ ] [ ] [ OK ]
-------------------------------------------------------------------------------------------------

<b>CALIB. OF CURRENT</b> <b>CALIB. 1 (- - -)</b> <b>X.XXXX■ mA</b> [ < ] [ > ] [ ↵ ] [ ↑ ]
-----------------------------------------------------------------------------------------------------

The Communicator confirms performance of the calibration by displaying message „CURRENT CALIBRATION SUCCESSFULLY EXECUTED“.

## 2) Calibration of transmitter input.

### BTT3298ALW transmitter

Function makes possible calibration of channel 1 -( transmitter with a single sensor)  
or channel 1 and 2 - (transmitter with two sensors).

<b>--CALIBRATION INPUT--</b> <b>CALIBRATION CH1</b>  [ < ] [ > ] [ ↵ ] [ ↑ ]	<b>--CALIBRATION INPUT--</b> <b>CALIBRATION CH2</b>  [ < ] [ > ] [ ↵ ] [ ↑ ]
---------------------------------------------------------------------------------------	---------------------------------------------------------------------------------------

Calibration is realized by two points (lower and upper point of calibration).

<b>--CALIBRATION INPUT--</b> <b>LOWER CALIBRATION</b> <b>POINT</b>  [ < ] [ > ] [ ↵ ] [ ↑ ]	<b>--CALIBRATION INPUT--</b> <b>UPPER CALIBRATION</b> <b>POINT</b>  [ < ] [ > ] [ ↵ ] [ ↑ ]
---------------------------------------------------------------------------------------------------------	---------------------------------------------------------------------------------------------------------

In aim of calibration is necessary to put on the sensor a standard temperature and wait on her stabilize.

<b>SET TEMPERATURE</b> <b>AND WAIT FOR IT TO</b> <b>STABILIZE</b>  [ OK ]
---------------------------------------------------------------------------------------

Then is necessary to write the worth of a standard temperature

<b>- LOWER CAL. POINT -</b> <b>WRITE VALUE PATTERN</b>  <b>100.00 °C</b>  [ < ] [ > ] [ ↵ ] [ ↑ ]
------------------------------------------------------------------------------------------------------------------

After carrying out calibration operation the Communicator displays message „CALIBRATION SUCCESSFULLY EXECUTED“.

The values of assumed calibration points do not have to be equal to the upper and bottom limits of the basic range but these may not go beyond them, i.e. be higher and lower respectively. The breadth of the calibration range may not be smaller than the minimum breadth of set range. In order to reach the best possible accuracy it is recommended that the calibration points and the beginning and end points of the set range have the same or near values.



### 3) PROCESS VARIABLES LCD1.

This function enables displaying an appropriate process variable in the upper right corner of the LCD display. It is possible to display values of current, range percentage.

### 4) COMMA

This function enables setting a comma in any position of the number displayed on the transmitter's LCD screen.

### 5) USER'S RANGE

#### a) User's units

This function enables changing units in which the values are displayed on the transmitter's LCD screen.

After displaying the current user unit and pressing the F3 key [↵] units may be changed.

**Typing in characters and figures** - according to the description in item 9.1.4

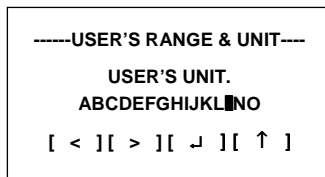

#### b) Beginning of range

This function enables changing the beginning value of the range, which is displayed on the transmitter's LCD screen. The current value is displayed on the screen.

The F3 key [↵] enables modification of the value.

**Typing in figures** – according to the description in item 9.1.3.

#### c) End of range

This function enables changing the end value of the range, which is displayed on the transmitter's LCD screen. The current value is displayed on the screen.

The F3 key [↵] enables modification of the value.

**Typing in figures** – according to the description in item 9.1.3.

### 6) LOCK FOR THE LOCAL SETTINGS

This function enables switching on or off the lock for the local settings.

The current status is signalled by displaying one of the following two messages: ON, OFF.

The status may be changed by means of the F3 key [↵].

## 12. PROCESS VARIABLES

This function is available after pressing the PV key on the Communicator. It enables current viewing the following process variables:

- FIRST PROCESS VARIABLE PV
- SECOND PROCESS VARIABLE SV
- THIRD PROCESS VARIABLE TV
- FOURTH PROCESS VARIABLE FV
- RANGE PERCENTAGE
- CURRENT (MA)

The information is refreshed every 0.9 seconds. Moving between the available variables is possible by means of the F1 [ < ] and F2 [ > ] keys.



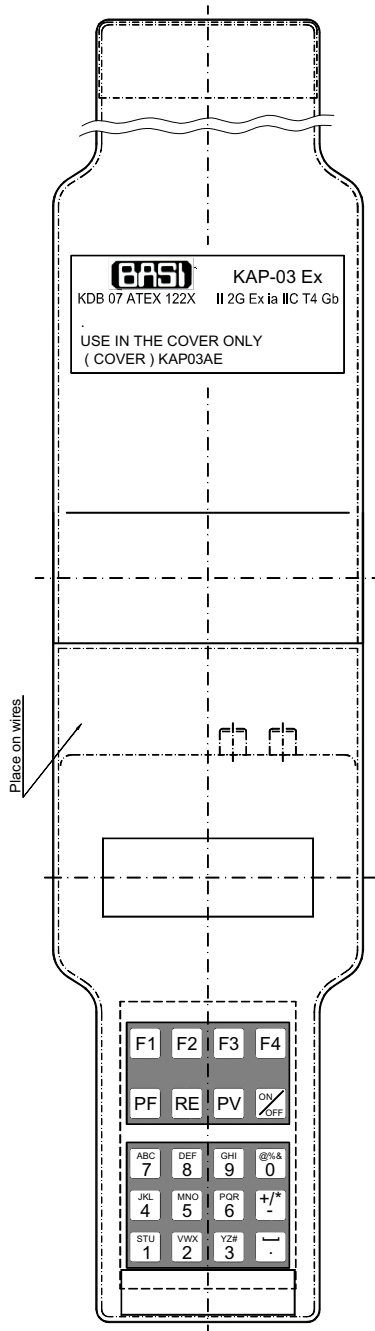

Fig.2 Cover of KAP-03Ex communicator

