



ULTRASONIC LEVELMETER BULT200 MANUAL

Used for process control in the liquid/solid level and other objects position measurement



Compact 2-wire Series

Safety instructions

The instrument for low voltage DC power supply (DC24V), power supply should meet the technical requirements

The metal housing should be connected with the earth

Please read the manual of this instrument carefully before putting the instrument into operation

All operations described in this manual must be carried out only by trained specialist personnel

This manual is for products that have the appearance of the following electronic units:

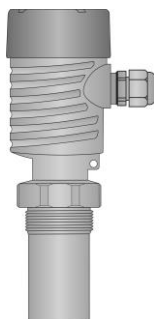

Table of contents

1. Introduction

Uses:

Liquid level, solid level or object position measurement.

Application:

The liquid level surface , material surface or solid surface that the ultrasonic can transmission effectively. Such as: storage tanks, troughs, measuring boxes, ponds, tanks, wells, drains, granaries, silos, moving objects.

Features:

- Two-wire connection, strong ultrasonic emission, stable and reliable measurement
- Optional HART output function, HART7.5 version, and backward compatible
- Without HART hand-held Communicator, HART parameters can be simply set by the instrument itself
- Large LCD display, easy to debug and observe
- Over-voltage and over-current protection, lightning protection
- Intelligent signal processing technology to ensure that the instrument to adapt to a variety of working conditions
- All plastic probe,good acid and alkali anti-corrosion, to adapt to harsh environments

The measuring range:

The meter has the following range specifications:

Liquid level: 4m、6m、8m、12m、15m、20m、30m

Solid Level: 3m、5m、7m、10m、15m

Note:

1. The above range is only for relatively calm liquid level measurement, for the liquid level fluctuations, liquid volatile easy to make the ultrasonic probe surface condensation,solid level measurement and other conditions, the effective range of about 50% of the above data, it is recommended to select a larger range (higher power) .
2. Outdoor installation in cold areas, should prevent the probe surface frost or icing.Probe lengthened type is optional, the probe can enter into the container inside.Or select the four-wire with probe heating function type.

2. Structure:

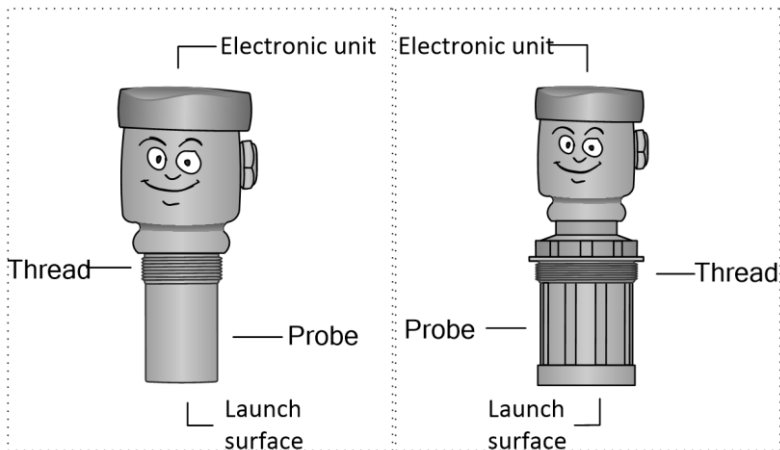

4m, 6m, 8m

12m, 20m, 30m

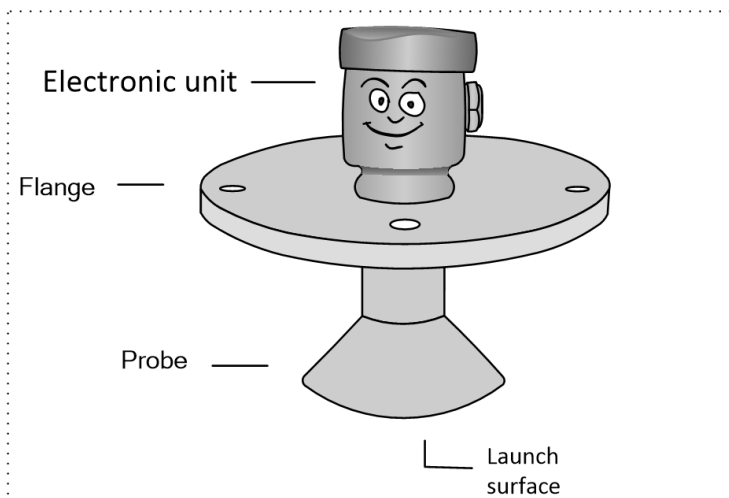

20m, 30m Horn Type (Small beam angle)

3. Measuring principle

Level meter consists of an ultrasonic probe and an electronic unit. Level meter is mounted on top of the container, under the control of the electronic unit, the ultrasonic probe transmitting ultrasonic pulses to the measured object. Sound waves are reflected by the surface of the object, part of the echo received by the probe and converted to electrical signals. The meter measures the time between pulse transmission and reception. The time is proportional to the distance from the probe to the measured object. The electronic unit detects this time and calculates the measured distance based on the known sound velocity. Level value can be obtained by the subtraction.

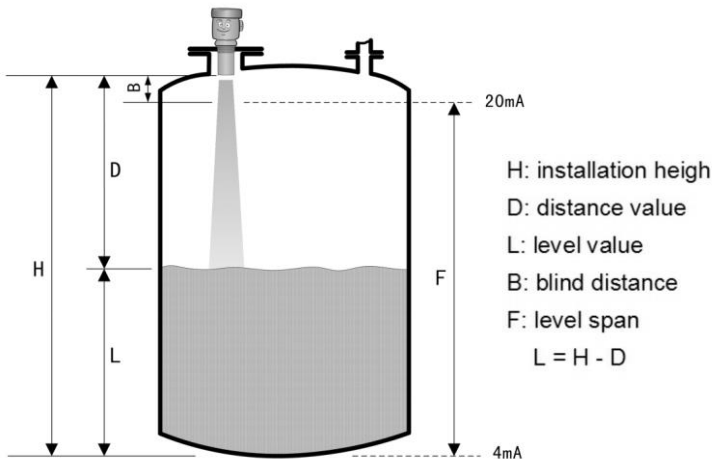

The speed of ultrasonic wave in the air is affected by the air temperature, therefore, the Ambient temperature needs to be detected when the level meter works, and the sound speed is compensated to ensure the measurement accuracy

.Blind zone: Span F may not extend into the blind zone B. Level echo from the blind zone cannot be evaluated due to the transient characteristics of the sensor.

4. Technical data

The measuring range:

Type Condition	4m	6m	8m	12m	20m	30m
Relatively calm liquid, flat solid	4.00m	6.00m	8.00m	12.00m	20.00m	30.00m
Drastic fluctuation, strong volatile liquid	3.00m	4.00m	6.00m	9.00m	16.00m	25.00m
Blocky, particles solid			4.00m	6.00m	12.00m	20.00m

The blacking distance:(From the sensor surface)

MODEL	4m	6m	8m	12m	20m	30m
Blacking distance	0.20m	0.25m	0.30m	0.50m	0.80m	1.00m

Accuracy	0.2% of full span (in air, stationary plane, standard signal strength)
Display resolution	1mm (Less than 10m type) 1cm (more than 10m type)
Display	4 digit LCD
Output current	4-20mA (HART function is optional)
Output load	0-500Ω
Parameter set up	3 Membrane buttons
Temperature range	Electronic unit : -40°C~+75°C (LCD: -20°C~+70°C) Sensor(PVC/ABS): -40°C~+75°C Sensor(PTFE/PVDF): -40°C~+100°C
Temperature compensation	Full range automatically.
Pressure range	-0.04~+0.1MP(Except for the following models) 4m/6m/8m,4m/6m/8m-F:-0.04~+0.2MP

Power supply	DC24V($\pm 10\%$), 30mA
Cable diameter	$\Phi 6\sim\Phi 12\text{mm}$
Single wire diameter	$\Phi 0.5\sim\Phi 1.78\text{mm}$
Cable gland	PG13.5/M20
Measure cycle	1.5 second (changeable)
Beam angle	5°(3db) for range :12m-D and 20m,30m horn probe 8°(3db) for any other range probe
Housing material	Aluminium,Plastic(ABS)、
Sensor material	ABS/PVC/PTFE/PVDF
Protect grade	IP67
Fix	Thread ,flange or bracket

Mounting dimensions

ABS/PVC Probe

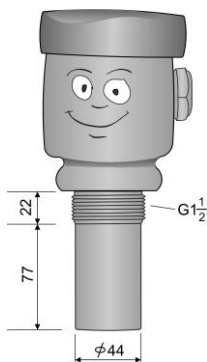

4m-S、6m-S

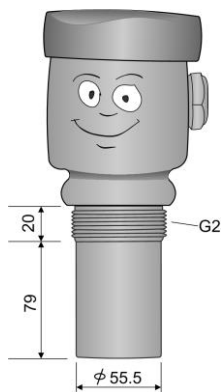

4m、6m、8m、
12m (Standard)

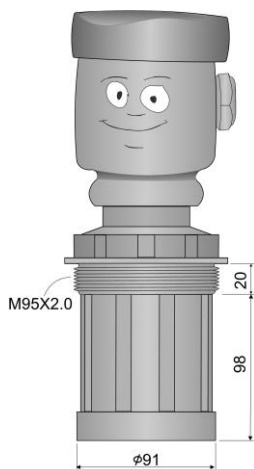

12m-D (Small beam
angle) 20m、30m

PTFE/PVDF Probe

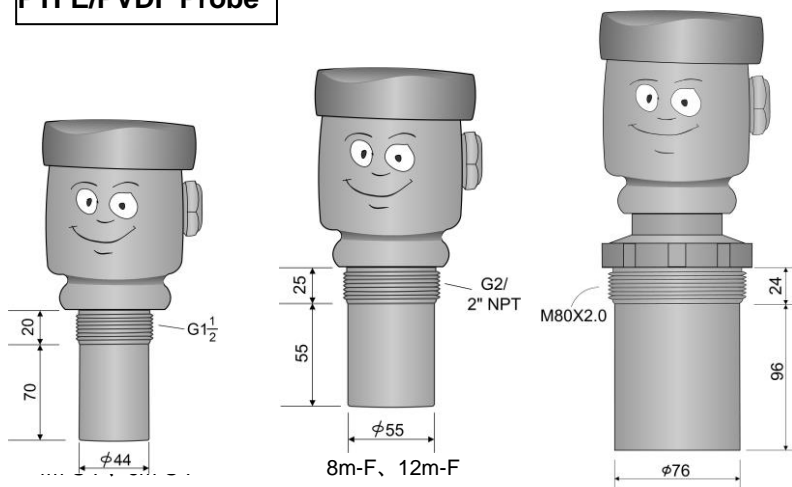

Horn Probe

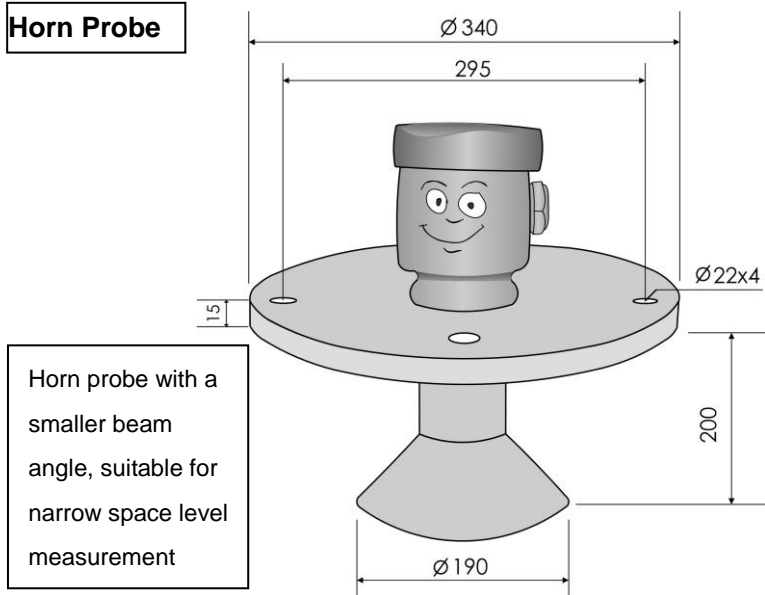

20m, 30m Horn type

Probe launch surface dimensions :

PTFE/PVDF probe is a flat probe, the front of other materials probe structure is horn.

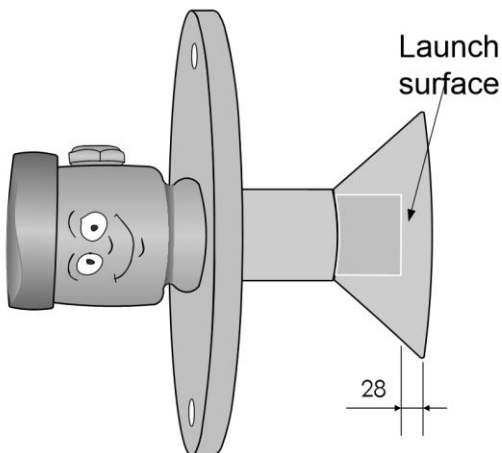
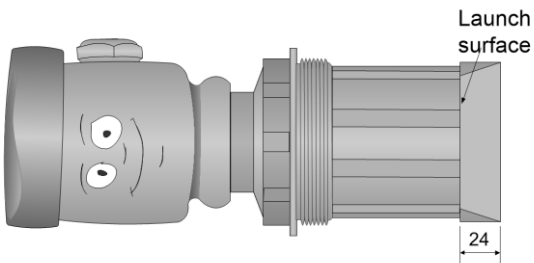
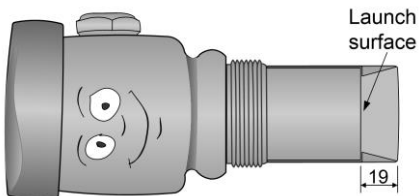

Note:

The detection distance and the dead zone value should be calculated from the launch surface of the probe.



Panel layout of the electronics unit

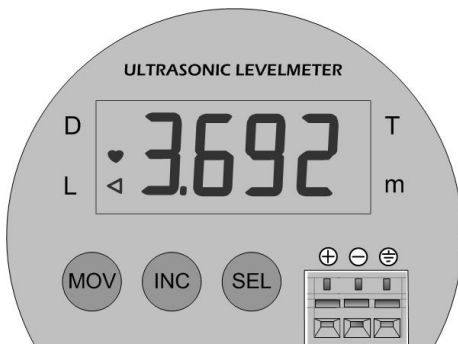

Wiring diagram

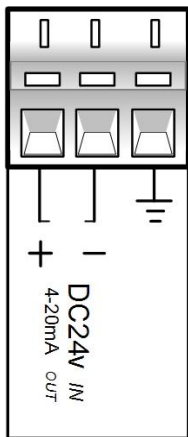

Use a small slotted screwdriver
Insert the wire as shown above

Note:

The power supply for the level meter is DC24v, please note the wiring marked, and the actual wiring marking on the level meter. The external loop should have a current supply capability of 30mA.

Outdoor use, the metal housing should be connected to the earth, in order to ensure the instrument lightning protection capability.

HART Communications and Settings (Optional).

- Comply with the HART 7.5 standard ,backward compatible.
- Have been tested by the HART Foundation accredited laboratory.
- Part of HART settings can be setup by the instrument's button.
- Support the common functions of the HART Communicator.
- Support all HART 7 Universal Command and some Common Practice Command.

Common features:

- Read and Write Identifier,Tags or Messages.
- Read Primary Variable(Level Value),Loop Current and Percent Of Range.
- Read Secondary Variable (Distance Value).
- Read Tertiary Variable (temperature Value) .
- Write Polling Address(0~63).
- Set Range Value.
- Trim Loop Current.

Connection with the HART Communicator.

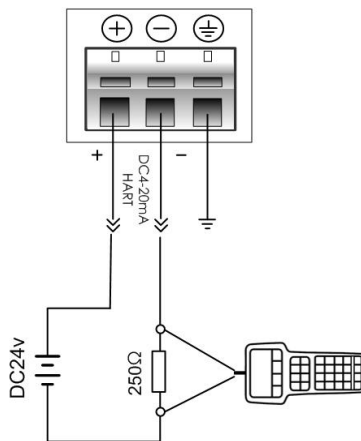

Operation

Display and keys

The series is displayed with 4 digit LCD.

The series has 3 keys, with its functions as follow:

SEL	Selection of the display content or parameter
INC	Changing the value of the certain digit from 0 to 9 in turn
MOV	Selection of the digit to be changed

Two working mode

The instrument has two working mode:



Measurement mode

Program mode.

Press **SEL** and **MOV** simultaneously to switch between these two mode. After entering the Program mode, the corresponding indicator will change.

Measurement mode

The **level** value, the **distance** value and the **temperature** value will be shown in turn by pressing the **SEL** key in measurement mode. Please pay attention to the indicate symbol:

Display Value	LCD	Description
Level Value		Flashing arrows point to L(Level)
Distance Value		Flashing arrows point to D (Distance)
Temperature		Flashing arrows point to T (Temperature)

POWER ON Power on the instrument shows the boot symbol. After a few seconds, the level or distance value is displayed. The ▲ symbol flashes on the left of the screen, indicating that an echo is received. At the same time, the symbol ▲ point to the variable abbreviation (L, D, T) on the panel to indicate the corresponding current display value.

When the meter is powered on, reset or exited from the parameter setting status, the level or distance value is first displayed, which is determined by the currently selected measurement variable (selected in the parameter setting).

KEYS Press the **SEL** , the level meter can switch to select the display level value, distance value, temperature value.

Press the button should be released immediately.

In running state, **INC/MOV** key is invalid.

Press the **SEL**, **MOV** key together and instantly release the key to enter or exit the parameter setting state.

RESET Press **SEL** and **MOV** at the same time and hold for more than 4s can reset the meter and enter into the parameter setting state, press the **SEL**, **MOV** key at the same time and instantly release to exit.

DISPLAY AND CURRENT OUTPUT

Level and distance unit is the meter (foot can be set in the inner setting), the temperature is °C.

The distance value is directly obtained by the level meter, level value is the installation height value to subtract the measured distance value obtained. Therefore, the distance value must be accurate, the installation height must be accurately set.

Ambient temperature affects the accuracy of sound velocity, temperature values should be displayed correctly.

Without HART function, the current output corresponds to the measured variable (level or distance) selected in the parameter. With HART function, the current corresponds to the level only.

Installation height must be accurate and should be greater than or equal to the distance measurement value. If it

is less than the distance measurement value, then the left two symbols flashing at the same time, the level value and the corresponding current value does not change, but the distance value changes (If the PV is set as the distance value, the current output changes).

If the level meter displays only the boot symbol for a long time after power on, or if the **SEL** key is pressed, the instrument level and distance measurement display 0.000 while the symbol do not flashing that the level meter fails to work normally.

Program mode

When **SEL** and **MOV** keys are pressed simultaneously, the instrument can enter or exit of the mode.

Press **SEL** key to select the content in turn in program mode, please pay attention to the symbol in the following examples.

Parameters	Significance
Installation height	The distance from the surface of the probe to the bottom of the container; unit is m (ft can be choose from the inner setting).
Full span	The 20mA output corresponding to the maximum value of the PV. Can also be programmed by the hart hand-held programmer.
Zero span	The 4mA output corresponding to the minimum value of the PV. Can also be programmed by the hart hand-held programmer.
PV select	Select the 4-20mA corresponding to the level or the distance value. When the setting is HL99 the current corresponding to the distance value. The any other value the current corresponding to the level value. (This parameter is not available with

	HART function, the current output corresponds to the level value.)
Address select	Setting the local HART polling address (00~63) (This parameter is only available with HART function)
Inner password	The password for inner parameters setting. Users do not need to set up this parameter.

With HART function

Parameters	LCD
Installation height	5278
Full span	6000
Zero span	0000
Address select	Pd00
Inner password	00



Without HART function

Parameters	LCD
Installation height	5278
Full span	6000
Zero span	0000
PV Select	HL00
Inner password	00

SET PARAMETERS

- In Measurement mode, press **SEL**, **MOV** simultaneously into **program mode**. The LCD displays the value of **Installation height**:



- press **MOV**, to select a certain bit, the bit will be dark, then press **INC** to change the digit:



3. press **MOV** , to select other bits, and press **INC** to change the digits:



4. press **SEL** to save the value and select next parameter, **full span**:



5. as the same way, to change the value of full span.

6. press **SEL** to save the value and select next parameter, **zero span**:



7. as the same way, to change the value of full span.

8. press **SEL** to save the value and select next parameter, **pv select** or **address select**:(If there is no HART function, the parameters is pv select.)



9. as the same way, to change the value of pv select.

10. the last parameter is **inner password**, it needn't to be change.



11. press **SEL** back to preceding parameters, check the values.

12. press **SEL** and **MOV** simultaneously, the instrument can exit of the operating mode.

The current output correspondence

Current = $[(PV(\text{Primary Variable}) - \text{Zero span}) / (\text{Full span} - \text{Zero span})] * 16\text{mA} + 4\text{mA}$

e.g:

① The Primary variable is Level (the variable is selected as HL00), the Level value is 3.626m, the Full scale is set to 6.000m, the Zero scale is set to 0.000m, the current output is:

$$[(3.626 - 0.00) / (6.000 - 0.000)] * 16\text{mA} + 4\text{mA} = 13.67\text{mA}$$

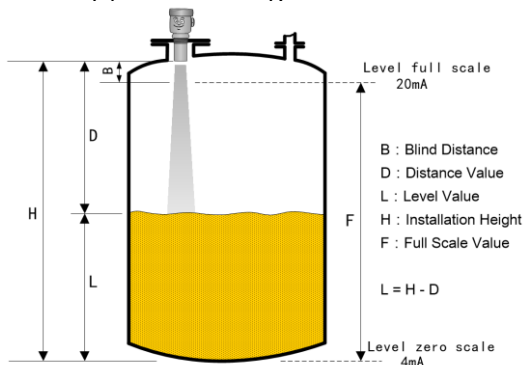

② The Primary variable is distance (the variable is selected as HL99), the distance value is 2.365m, the Full scale is set to 6.000m, the Zero scale is set to 0.500m, the current output is:

$$[(2.365 - 0.500) / (6.000 - 0.500)] * 16\text{mA} + 4\text{mA} = 9.43\text{mA}$$

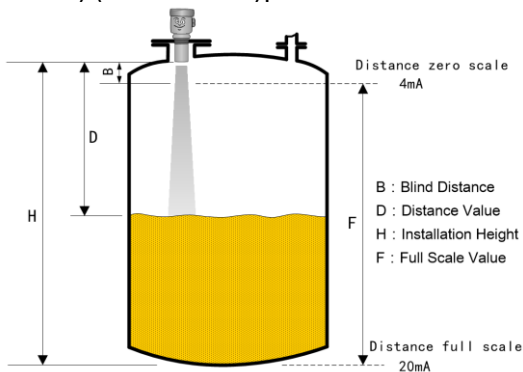

PV is distance value (HL99)

Instrument inspection

1. Power supply should be correctly connected by the identification. The voltage of Level meter is DC24V. External power supply should have a 30mA current supply capability to meet the startup current requirements.

2. Place the level meter perpendicular to the wall, the measured distance must not within the blind distance and there should no obstacles. Power up the level meter.

3. The level meter first shows the boot symbol and then shows the level value.

4. Press the **SEL** key, the meter can switch display distance value, temperature value and level value.

5. Slowly move the level meter, the level or distance value displayed on the meter should be changed accordingly.

When moving within close range (1m), speed should not exceed 0.1m / s.

There is a detection window inside the level meter. The target beyond the detection window needs to have a judgment time of about 5s. The measurement window below 10m is usually $\pm 0.5\text{m}$, and the window above 10m is $\pm 1.2\text{m}$. Due to the detection window, the distance sudden change from far to near about 1/2 of the distance, errors may occur. The sudden change of distance usually does not exist in the actual measurement.

6. Press **SEL** and **MOV** keys simultaneously to enter the program mode, set the installation height, full scale, zero scale and other parameters

The installation height must be greater than or equal to the maximum distance value of the level meter. If the distance value is greater than the installation height, the left symbol flashes, the level value does not change, and the current output does not change if PV is set as the level value. But if the PV is set as the distance value ,the current will change.

7. Use ammeter to measure 4-20mA current output.

8. Connect the HART hand-held communicator to the level meter to test the functions related to HART communication.

The full scale , zero scale and POLLING address via the HART hand-held communicator is the same as the result set by the keys on the meter.

Installation height can not be set by the HART hand-held communicator.

5. Installation

Reasonable installation is critical factor of the instrument's normal working.

Level meter installed in the top of the container. Probe launch surface perpendicular to the liquid or material surface. If a sealed container mounting flange should be used. Other cases can be mounted bracket.

Flange mounting, **plastic** flange recommendations formulated according to the size of the thread on the level meter. 20m, 30m horn type level gauge has been directly equipped with flange (DN200).

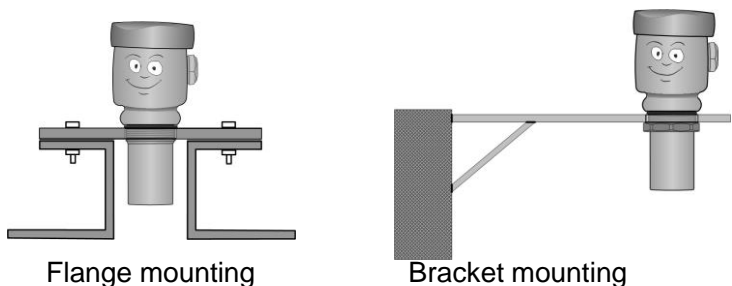

Mounting measures

■ Ultrasonic emission, having a small spread angle. If other objects within the spread angle obstruct and form equal to or less than 90° reflection angle, reflection will occur. If the reflection is very strong, measurement errors will result. The smooth and flat side of the container does not reflect the ultrasonic waves coming from above. **The installation distance between the meter and the side wall should be**

more than 10% of the measuring range and not less than 0.4m.

■ When flange mounting, plastic material flange is recommended. It is best to specify the size of the installation flange when ordering, direct preparation by the manufacturer.

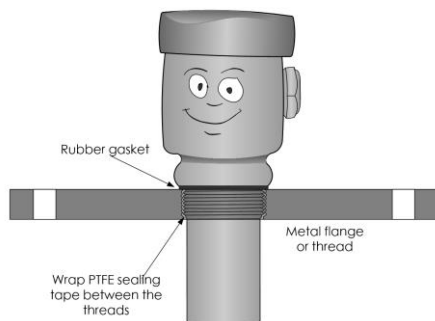

If installed on metal flange or metal thread, please install as above. To avoid resonance, resulting in measurement errors (large measure liquid level than actual value)

■ In the case of a closed container, the flanges and short tube on the container shall meet the following requirements:

Type	4m, 6m, 8m	12m, 20m, 30m	20m, 30m Horn
Requirement	Flange diameter should not be less than 65mm, short socket of the inner wall is smooth and large diameter, the length should be short, < 400mm.	Flange diameter should not be less than 100mm, flange socket length should be less than 150mm and the inner wall is smooth. The probe should extend from the mounting opening.	Flange diameter should not be less than 200mm, flange socket length should be less than 200mm, the probe should be extended from the mounting opening.

■ Install the installation as far away from the uneven container wall, away from the ladder in the container, sprue, mixing

blades and other things that can block the sound waves.

■ Installation port, flange socket too long, will affect the sound wave propagation, reduced effective range. The probe should be extended from the mounting opening or close to it

■ If there is fluctuation in liquid level, or if there are float balls, foam, strong liquid volatility, probe easy condensation, objects that block sound waves, etc., which can be solved by adding a plastic tube to the container, so that the sound waves spread only in the plastic pipe, to ensure the stable and reliable of the measurement .It requires plastic pipe wall is smooth, flat, seamless. The pipe should from the flange to the bottom of the container. Two small holes must open in upper and lower ends of each side of the tube , to ensure consistent level of inner and outer tube. If the plastic tube can not be down to the bottom of the container, a oblique truncated short tube can be use

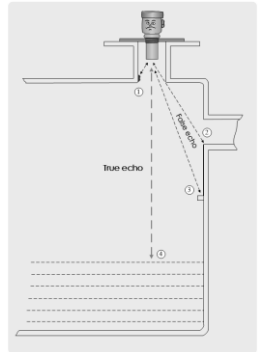

use

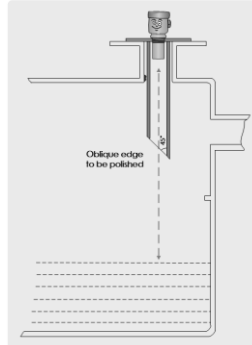
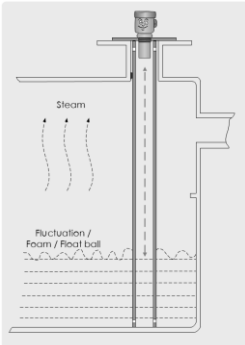

Add plastic tube effectively eliminate all kinds of interference and improve detection ability

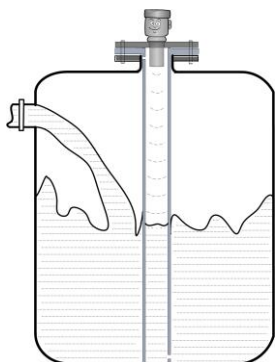

Add plastic tube to make level measurement stable

Add inclined plastic tube shielding produce false signal location

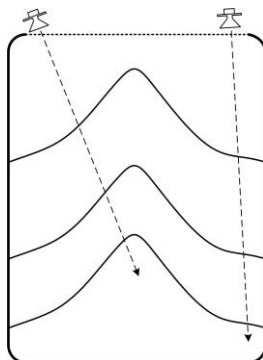

Level measurement instrument installation position and angle signal position

■ Make sure the distance between the probe surface and the maximum level exceeds the blind distance.

Instrument can be properly increased the height of installation. When using the closed container, the inner wall of the the tube should be smooth, and its inner diameter should not be larger than the inner diameter of the flange of the container. The increased height installation will reduce the effective range.

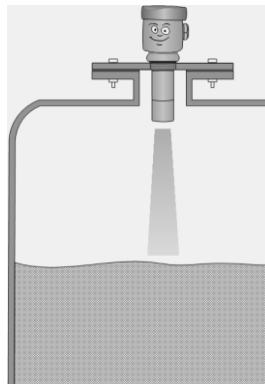
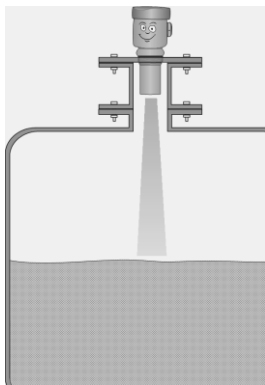

Level meter higher installation,
eliminate blind effect

Probe lengthened, to avoid
frosting, icing

■ When install to the cold area, such as measuring the level of liquid in a closed container, should choose the lengthen probe of the level meter, make the sensor extend into the container to avoid frosting or freezing.

Or select a four-wire level meter with electric heating function.

■ level meter probe launch surface should be as vertical as possible

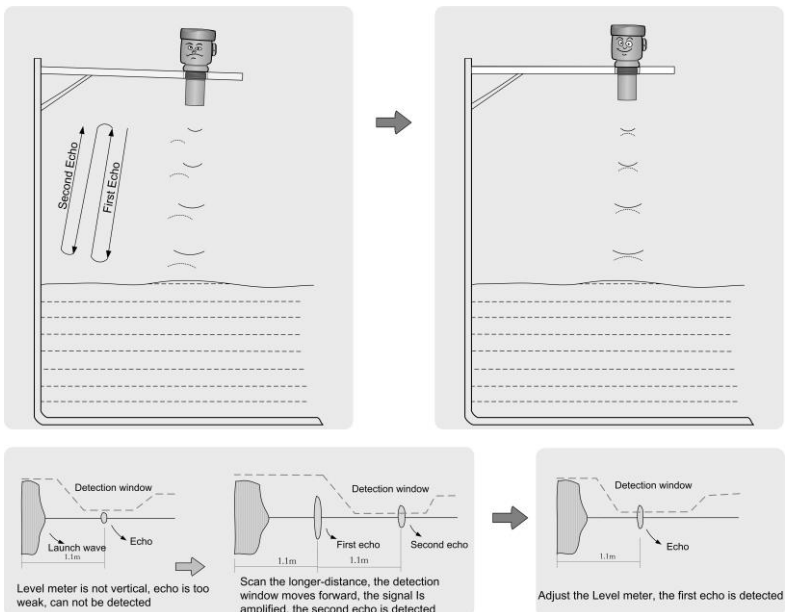

Level meter installation is not vertical, the measurement level value may be smaller than the actual value or impossible to measure

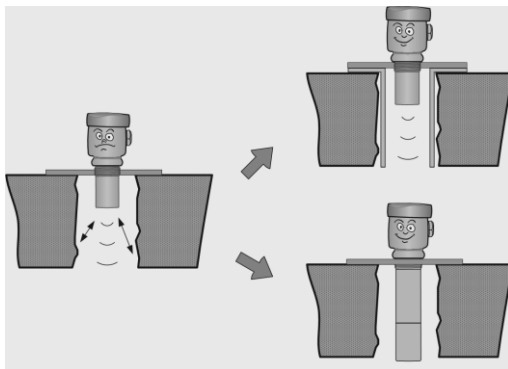

Irregular openings, easy to produce false signals, plastic short tube can be mounted or choose the lengthen probe type.

Power work

The meter will first appear the boot logo after it is powered on. The level value will be displayed after a few seconds, while the ▲ symbol on the left side of the display flashes, indicating that an echo has been received.

The actual measurement of the level meter is the distance from the probe to the liquid surface or material surface, then converted to the level value, which is very important principle.

Press the **SEL** key to view the distance value and temperature values. If the distance value is the same as the actual value, it indicates that the level meter status is good state and the relevant parameters can be set.

Press **SEL** and **MOV** keys simultaneously to enter the program mode, set the installation height, full scale, zero scale and other parameters, then press the SEL button to save. Then press **MOV**, **SEL** simultaneously to return to measurement status. The meter will display the correct level value while outputting the correct current signal.

The relevant HART communication parameters can also be set via the Hart hand-held Communicator.

If there is a measurement error, please refer to the section "Troubleshooting" below and read through the "Installation" section again to identify the problem and resolve it, or consult the manufacturer.

Instrument seal

After the instrument setting is completed and working , Tighten the water proof cable gland, the cable is preferably to bend downwardly , to prevent water infiltration.

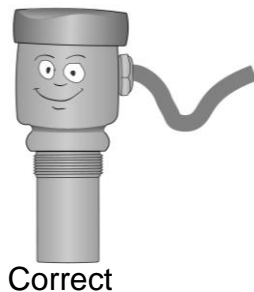
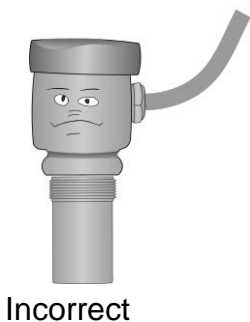

6. Troubleshooting

The failure of the meter should be judged from the following aspects:

1. First of all, to determine whether the instrument power supply is normal.

2. After that, confirm that the instrument itself has no trouble.

Align the meter with the ground or wall to see if the meter can be properly tested.

3. Check the parameter settings to confirm that the parameters are set correctly.

4. Compare the mounting requirements, check the mounting.

5. Check the application environment, whether there are adverse factors affecting the measurement.

6. Check whether the level metre had been water damaged, causing corrosion of the electronic circuit.

7. Refer to the next page of the symptoms and solve the problem.

8. Consult the the level meter supplier or manufacturer.

Trouble-shooting

Trouble Phenomenon	Trouble Reason	Solution
The level meter does not display	Power supply error. Wiring error. Instrument water, corrosion of the corridor line	Check the power supply and the current output Check the wiring. Return to factory maintenance
The meter is display but it does not work Or sometimes impossible to measure	The sensor doesn't aim at the liquid or the material. The surface has great fluctuations or large volatile liquid Liquid surface with lots of foam. The container is empty and the bottom is not flat. Over the range.	Adjust the sensor and aim at the material. Add a tube to the container or switch to a larger range of level meter Add a tube to the container or use radar level meter Use instrument with a lager range. Use instrument with a lager range.
The instrument shows unstable or the measured value has a great deviation.	The level enters the blanking distance. There is strong electromagnetic interference There is Obstruction of the ultrasonic wave.	Increase the installation height of the instrument. or prevent the level too high. Increase shielding to the instrument. Change the installation site or using a plastic tube.