

MANUAL

BASI

Ultrasonic Open Channel Flow Meter

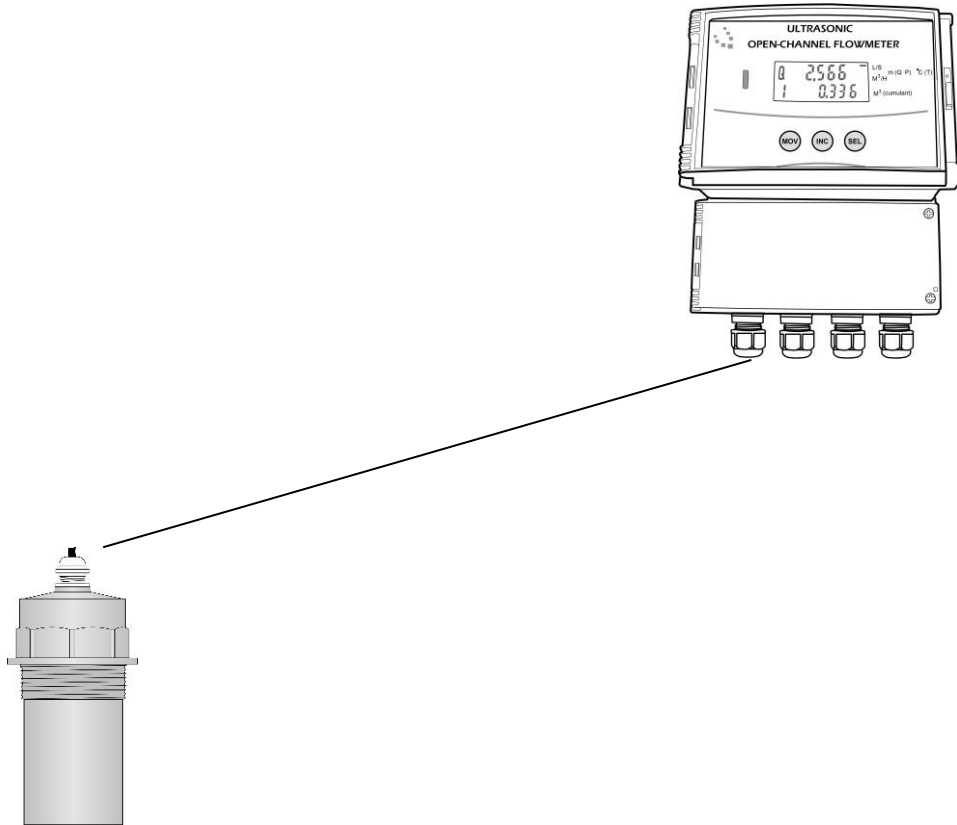

Catalog

1.	Introduction	2
1.1	Application	2
1.2	Features	2
1.3	Structure	3
1.4	Measuring principle: Time-of-flight method.....	4
1.5	Technical data.....	5
2.	Installation	6
2.1	Installation considerations	6
2.2	Mounting dimensions	9
3.	Wiring.....	12
3.1	The host	12
3.2	Wiring diagram.....	12
3.3	The cable	13
3.4	The terminal blocks	13
4.	Operation	14
4.1	Display and keys	14
4.2	Two working mode	14
5.	Calibration	22
	General consideration.....	23
6.	Serial communication-Modbus-RTU	23
	Address number.....	23
	Baud rate.....	23
	Parity Check	24
	Function code	24
	Abnormal corresponding	24
	Electrical connection	24
	The RTU mode.....	24
7.	Trouble-shooting	27

1. Introduction

1.1 Application

The BUFM660 series is a remote version ultrasonic open channel flow meters (O.C.M.). It consists of two elements, a wall mounted host, which has a display and an integral keypad for programming, and a probe, which must be mounted directly above the surface to be monitored. Both of the host and the probe are plastic leak-proof structure.

The BUFM660 series OCM can be widely applied to the environmental protection, water treatment, irrigation, chemical, and other industries.

1.2 Features

BUFM660 series O.C.M. is capable of the following functions:

- High detection accuracy, the flow meter measurement changes with 1mm, the accuracy of change in level is 1 mm;
- Suitable for a variety of weirs and flumes, Parshall flumes (ISO), Right-angle triangle weir, Rectangular weir;
- Displays flow rate in L/S or M³/h;
- Excellent anti-interference capability;
- Clear display with enhanced 14 digit two line backlit LCD;
- The cable length between probe and host up to 1000m;
- The probe with leak-proof structure and IP68 protect grade;
- Chemically resistant probe materials for maximum application flexibility;
- Provided 4-20mA output and RS485 serial communication (MODBUS-RTU) output;
- Provided programmable 6 relays at most for alarms;
- Three button for programming or remote control for easy configuration and operation (opt.) ;

1.3 Structure

The BUFM660 series O.C.M. consists of a probe and a host. The remote control is optional.

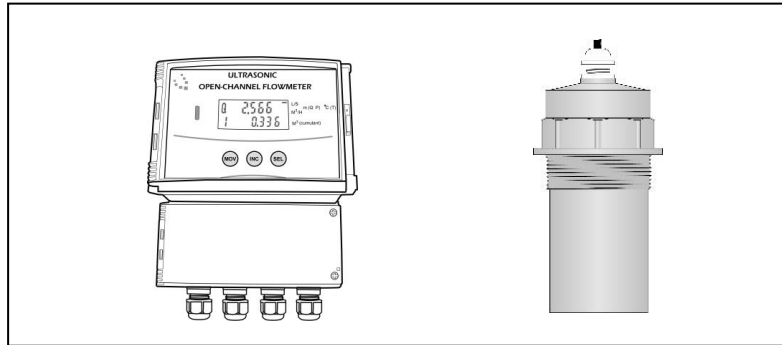

1.4 Measuring principle: Time-of-flight method

The probe is mounted on the top of the flume, and ultrasonic pulses are transmitted by the probe to the surface of the monitored material. There, they are reflected back and received by the probe. The host measures the time t between pulse transmission and reception. The host uses the time t (and the velocity of sound c) to calculate the distance d between the sensor bottom and the monitored liquid surface: $d = c \cdot t / 2$. As the host knows the installation height H from parameters setting, it can calculate the level as follows: $h = H - d$.

Since speed of sound through air is affected by changes in temperature, the BUFM660 O.C.M. has integrated a temperature sensor to improve accuracy.

For determined flumes, there is a fixed functional relationship between the instantaneous flow and liquid level. The formula is $Q = h(x)$. Q means instantaneous flow, h means liquid level in flumes. So the host can calculate the flow rate through determined flumes and the level value.

It is very important to understand the working principle for further installation and operation.

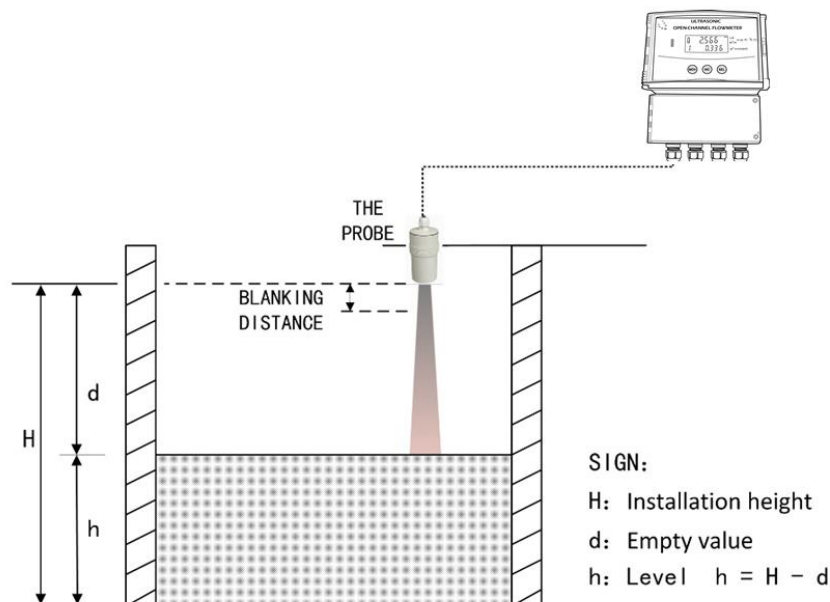

Blind zone: Level echo from the blind zone cannot be evaluated due to the transient characteristics of the sensor. Span F may not extend into the blanking distance B.

1.5 Technical data

1.5.1 The host

Type	BUFM660 (host)
Power supply	DC24V ($\pm 5\%$) 0.2A; AC220V ($\pm 20\%$) 0.1A
Display	2 lines 14 digit backlit LCD
The instantaneous flow rate range	0.0000~99999L/S or m ³ /h
The maximum of cumulative flow	9999999.9 m ³
Accuracy of change in level	1mm or 0.2% of measured distance from the probe at still water. (whichever is greater)
Resolution	1mm
Analogue output	4-20mA into 500 Ohms, corresponding to instantaneous flow rate.
Relays outputs	6 multi-function SPDT relays at most (optional) , rated 5A /250VAC/30VDC, high, low and failsafe alarm and control corresponding to instantaneous flow rate or level.
Serial communication	RS485, MODBUS-RTU standard protocol
Ambient temperature	-40°C ~70°C
Temperature compensation	Integral in probe
Pressure range	± 0.1 MP (press definitely)
Measure cycle	1 second (changeable)
Parameter setting	3 induction buttons / remote control
Cable gland	PG9 /PG11/ PG13.5
Material	ABS
Protect grade	IP67
Fix	Hang
Dimensions	248H*184W*122D(mm)

1.5.2 The probe

Type	BLB-4 (probe)
Range	0.00-4.00m
Blind zone	0.20m
Ambient temperature	-40°C~70°C
Temperature compensation	Integral in probe
Pressure range	0.2MPa
Beam angle	10 (3db)
Cable length	10m standard (can be extended to 1000m)
Material	ABS, PVC or PTFE (optional)
Protect grade	IP68
Fix	Screw (G2) or flange (DN65/DN80/etc.)

2. Installation

Reasonable installation is critical factor of the instrument's normal working. Installation must be carried out by trained person in accordance with the manual.

2.1 Installation considerations

2.1.1 hints for the host mounting

- The host should not be mounted in a confined space where temperatures may exceed the normal working temperature (-40~+70), if the host is mounted outside, it must be protected from direct sunlight or severe weather conditions.
- Ensure that the mounting surface is not subject to vibration and is not in close proximity to high voltage cables, contactors or drive controls.
- Select appropriate knockouts in the base of the enclosure and fit appropriate cable glands to maintain the IP67 rating.
- Do not use excessive force when tightening the fixing and avoid any distortion of the enclosure.
- Pay attentions to the dimensions of the host and the enclosure.

2.1.2 Hints for probe mounting

- The probe can be supplied as standard or with a screw nut or with an ordered flange.
- For applications requiring chemical compatibility the probe is available fully enclosed in PTFE.
- The use of metallic fittings or flanges is not recommended.
- For exposed or sunny locations a protective hood is recommended.
- Make sure that the probe is mounted perpendicular to the monitored surface and ideally, at least 0.25 meters above it, because the probe cannot get response in the blind zone.
- The probe has a 10 inclusive conical beam angel at 3 db and must be mounted with a clear unobstructed sight of the liquid to be measured. But smooth vertical sidewalls weir tank will not cause false signals.
- The probe must be mounted upstream of the flume or weir.
- Do not over-tighten the bolts on flange.
- The stilling well can be used when there is volatility in the water or needs to improve the accuracy of level measurement. The still well connect with the bottom of the weir or flume, and the probe measures the level in the well.
- When install to the cold area, should choose the lengthen sensor and make the sensor extend into the container, shun frost and icing.
- For Parshall flume, the probe should be installed in a position the 2/3 contraction away from the throat.
- For triangular weir and rectangular weir, the probe should be installed on the upstream side, the maximum water depths over the weir and 3~4 times away from the weir plate.

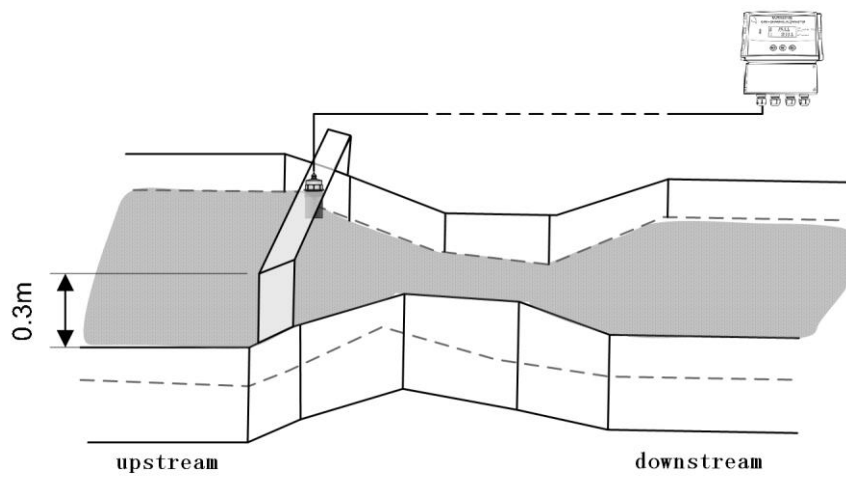

Parshall flume

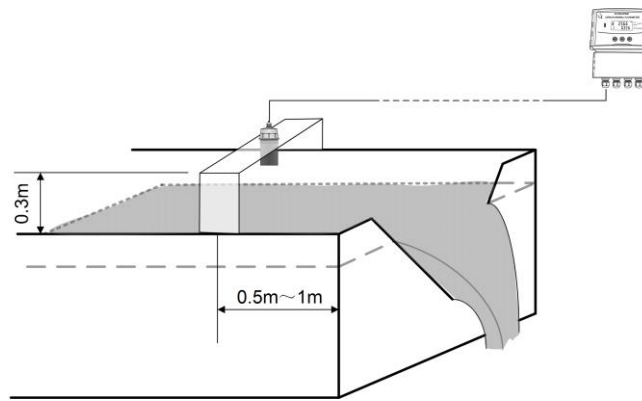

triangular weir

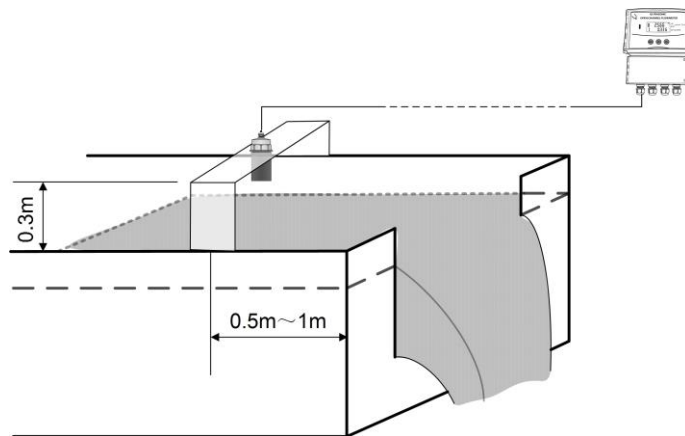

rectangular weir

2.2 Mounting dimensions

- The host

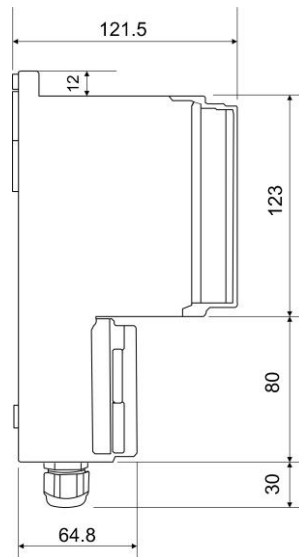
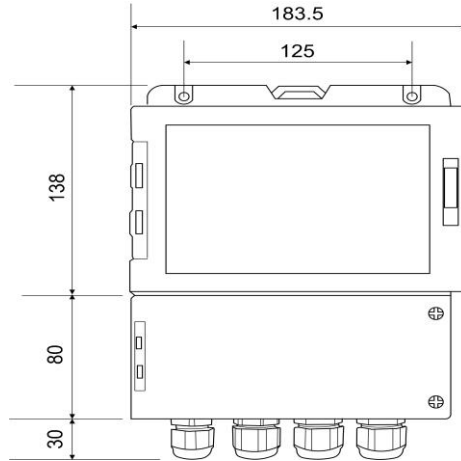

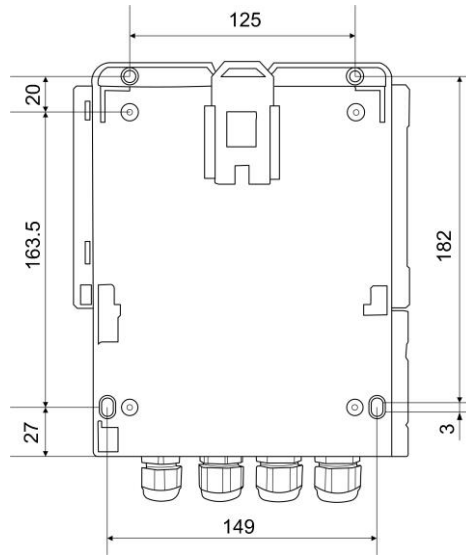

- The probe

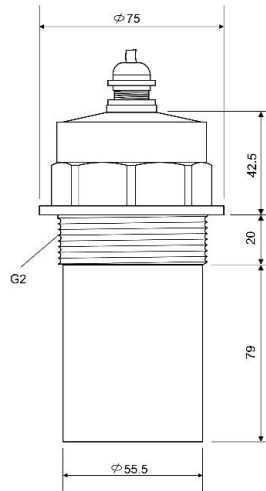

- The remote control

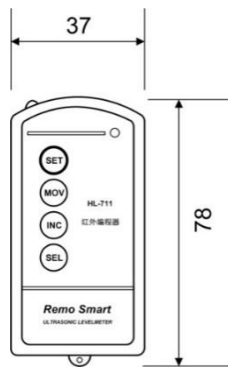

3. Wiring

The BUFM660 series O.C.M. has one LCD show and three keys for setting and some terminal blocks, which are located within the host housing and can be operated when the terminal cover is open.

3.1 The host

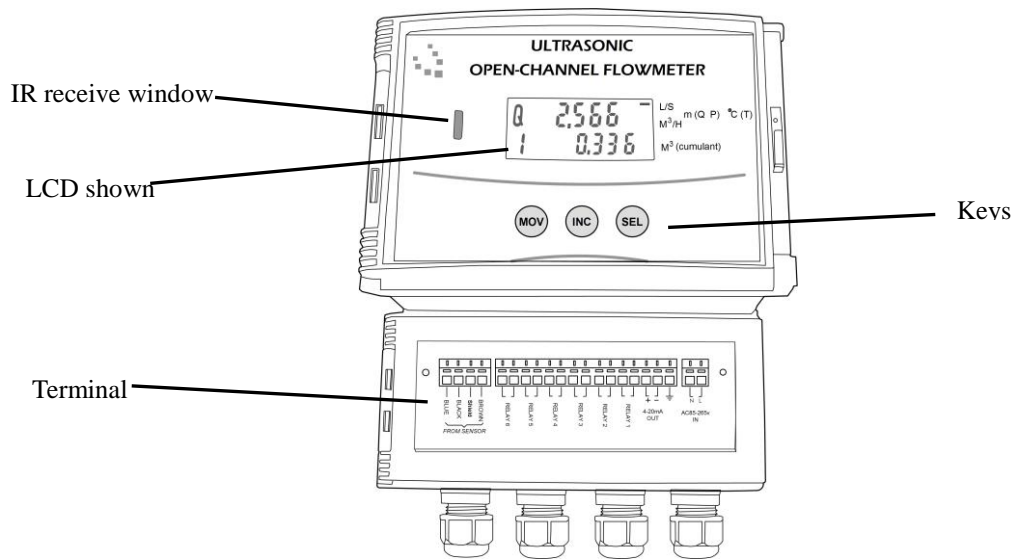

3.2 Wiring diagram

Remove the terminal cover to expose the terminals shown below. The wiring instructions are on bottom of the terminals as below.

- DC24V power supply

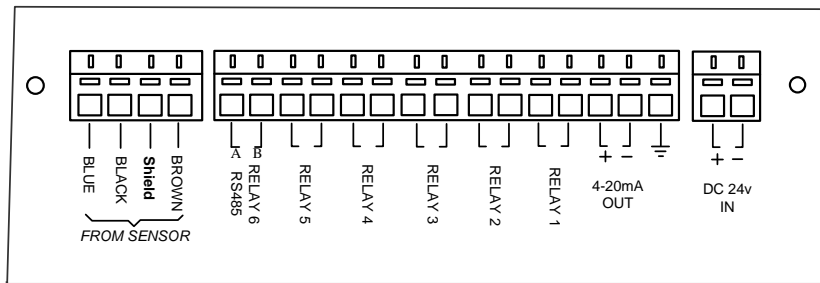

- AC220V power supply

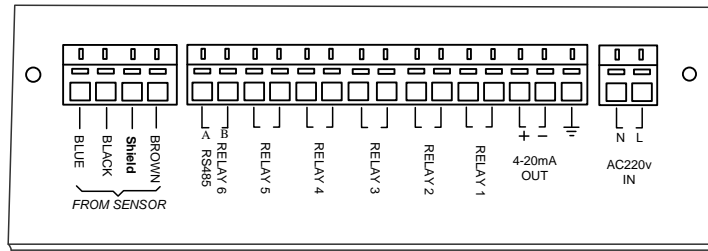

NOTES: The connection maybe different according to the different power supply and signal output.

When the RS485 serial communication function is provided, the relays can be provided with 5 pcs at most.

Carefully confirm the marked power supply terminals, to ensure the correct power supply connection.

3.3 The cable

The cable between probe and host is 10m standard. Users can extend the cable when desired, and the max distance between probe and host is 1000m.

The cable with three core shield wire is recommended.

3.4 The terminal blocks

The terminal blocks are all self-tightening ones. Use a straight screwdriver to wire as follow.

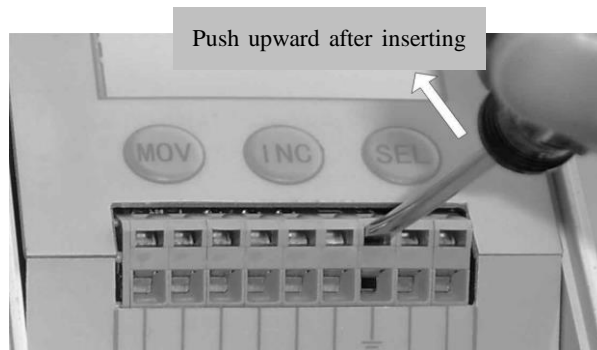

4. Operation

4.1 Display and keys

The BUFM 660 series is displayed with 14 digit LCD in 2 rows, and it has three keys, with its functions as follow:

Keys	Functions
SEL	Selection of the display content or parameter
INC	Changing the value of the certain digit from 0 to 9 in turn
MOV	Selection of the digit to be changed

4.2 Two working mode

The instrument has two working mode: running mode and programming mode. In running mode, the measurement is displayed. In programming mode, data is displayed to assist with setting some parameters.

4.2.1 Running mode

When the power is turned on, the instrument takes several seconds to initialize and then runs into the running mode to start the normal level and flow measurement.

In the upper line, there are four values which can be shown in turns by pressing **SEL** key : the instantaneous flow rate, liquid level value , distance value and temperature value.

In the lower line, the cumulative flow rate will be shown, and if there is active relay, then the number of the relay can be shown in the lower line.

To the left of the main display there will be alphabets shown to indicate the selected duty. And the measurement units are shown on the right side.



the instantaneous flow rate



liquid level value

distance value 

the temperature 

Notes:

- The instantaneous flow rate will be shown at first after powered on or exiting from programming mode.
- There are two units of measurement on the right side of the panel for instantaneous flow rate: M³/H and L/S, there is “-” symbol point to the current unit. It can be set up in programming mode with FU00 parameters to choose which unit to be shown.

- The unit of measurement for accumulated flow rate is M³, and the unit for liquid level and space is M, the unit for temperature is °C。
- The output current is always corresponding to the instantaneous flow rate, no matter which value disappears on the panel.
- The maximum of accumulated flow rate is 9999999.9m³, it will start from 0 to accumulate again after the maximum.
- The accumulated flow rate is saved per minute, it can be set up in programming mode with FCab parameters to reset or keep continuous accumulation.
- If the symbol “-” on the right side of the LCD display keeps flashing, that means the communication between the probe and the host is normal.
- If there is no echo, the BUFM660 will show like this.







-
- The installation height (H) must be set NO less than (\cong) the measured distance (D) value. If H is less than D, then the symbol in the left side will keep flashing, except the distance value, the instantaneous flow rate and level value and the output current will not change.
 - The BUFM660 series can provide 6 relays which may be used for control purposes. These relays are for *light duty* and should be used as signal relays only, with control functions being performed by external control relays.







4.2.2 Programming mode







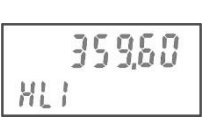

In the programming mode data is displayed to assist with parameter setting.



When **SEL** and **MOV** keys are pressed simultaneously and released them immediately, the instrument can enter or exit of the mode. Press **SEL** key to select the content, they will be shown in turn. In each parameter, press **MOV** to choose the changeable digit, the chosen digit will become dark, and press **INC** to change the value, numbers are shown 0-9 in turns. After setting the right values, press **SEL** to save and turn into next parameter.

Please pay attention to the sign in the following examples.

Significance	Shown parameters	Notes
Weir type number (Must be set correctly)		There are three types of weir can be chosen in this version BUFM660: Parshall flumes (ISO), Right-angle triangle weir, rectangular weir. This parameter displays in the form of "Pabc", "P" is unchangeable, the latter three digits "abc" determines the chosen weir type number. Please referring to the follow "the weir type number table".
Installation height (Must be set correctly)		The height is the distance from the bottom of transmitter to the bottom of the weir. The unit is M (meter).
Full scale of instantaneous flow rate (Must be set correctly)		The 20 mA output current corresponding instantaneous flow rate. Please set the value at first , the unit of the flow rate can be chosen in the latter parameters "Fuab". This parameter displays in the form of five digits "abcd0". The former four digits are changeable, the final digit "0" is unchangeable. And the position of the decimal is decided by the first parameter "Weir type number".
Calibration of output current		This parameter is used for correction of small output current error. The front two digits before the decimal point are used for correction of 20 mA, when the value increases, the 20mA output current will also increase. The latter two digits are used for correction of 4 mA, when the value increases, the 4 mA output will also increase, and vice versa.

The address number (RS485)		In RS485 serial communication, the instrument is used as slave, each one has an address number. The valid number addresses are in the range 0-247.
Communications setting		<p>This parameter displays in the form of “Cabc”, the last three digits “abc” are changeable, which decide the baud rate 、 transmission mode and parity check. The first digit “a” corresponds to baud rate (bit/s). When a=0, the baud rate is 19200; a=1, the rate is 9600; a=2, the rate is 4800.</p> <p>The second digit “b” corresponds to transmission mode. When b=0, the mode is RTU; b=1, the mode is ASCII (invalid now).</p> <p>The third digit “c” corresponds to parity check. When c=0, means even check; c=1 means odd check; c=2, means no check (8N2); c=3, means no check (8N1).</p>
Communications delay		The delay time for meter to send the data after receiving the master’s request. The format of this parameters is “d-bc”, the last two digits “bc” are changeable, and the value of “bc” decides the delay time in milliseconds. Such as d-10 means the instrument will send data after 10 milliseconds.
Status of relay No.1 (Correspond to instantaneous flow rate)		<p>The format of this parameter is “EC-ab”, the front two digits “EC” are unchangeable, the latter two “ab” determine the states of relay No.1.</p> <p>“a” corresponds to the contact status. When a=0, the relay No.1 is normally open; a=1, the relay No.1 is normally close.</p> <p>“b” corresponds to the high or low alarm status. When b=0, the relay No.1 is used as a low alarm, b=1, the relay No.1 is a high alarm.</p>
On and off point value of relay No.1 (Correspond to instantaneous flow rate)		The on and off point value of relay No.1, when the instantaneous flow rate is greater or less than this value, then the relay No.1 will work as its setting status. This parameter displays in form of 5 digit number, they can be adjusted except the final “0”. When all the five digits are “0”, then the relay No.1 will keep open status and stop working, no matter what kinds of status value be set.
Status of relay No.2 (Correspond to instantaneous flow rate or Accumulated Flow Pulse)		This parameter determines the status of relay No.2, its setting form is same with previous Relay No.1. But when it is set at “EC20”, the relay No.2 is used to output the Accumulated Flow Pulse. Accumulated flow for each additional 1m ³ , relay 2 will be

		energized again. The hold time is 500ms, after it will be disconnecting.
On and off point value of relay No.2 (Correspond to instantaneous flow rate)		Same with on and off point value of No.1. Correspond to instantaneous flow rate. But when the relay No.2 is set as Accumulated Flow Pulse , then this value is invalid, no need to set this parameter.
Status of relay No.3 (Correspond to level in the weir)		This parameter determines the status of relay No.3, its setting form is same with previous Relay No.1.
On and off point value of relay No.3 (Correspond to level in the weir)		Same with on and off point value of No.1. Correspond to level in the weir.
Status of relay No.4 (Correspond to level in the weir or Accumulated Flow Pulse)		This parameter determines the status of relay No.4, its setting form is same with previous Relay No.1. But when it is set at “EC20”, the relay No.4 is used to output the Accumulated Flow Pulse. Accumulated flow for each additional 1m ³ , relay 4 will be energized again. The hold time is 500ms, after it will be disconnecting.
On and off point value of relay No.4 (Correspond to level in the weir)		Same with on and off point value of No.1. Correspond to level in the weir. But when the relay No.4 is set as Accumulated Flow Pulse , then this value is invalid, no need to set this parameter.
Status of relay No.5 (Correspond to level in the weir or fault alarm)		This parameter determines the status of relay No.4, its setting form is same with previous Relay No.1. But when it is set at “EC20”, the relay No.5 is used as fault alarm, if there is fault with sensor or no signal detected, the relay No.5 will be closed , if not, it will keep opening.
On and off point value of relay No.5		Same with on and off point value of No.1. Correspond to level in the weir. But when the relay No.5 is set as fault alarm, then this value is invalid, no need to set this parameter.
The delay time of relays action		This parameter displays in form of “F-ab”, the last two digits “ab” determines the delay time of relays action. The unit is seconds. Such as it is set as “F-05”, it means the delay time of relays action is 5 seconds. This parameter is designed to prevent repeatedly open and close of the relays caused by the liquid surface fluctuation, also to avoid frequent opening of pump and alarms.

The unit selection of instantaneous flow rate		This parameter displays in the form of “FUab”, the last two digit “ab” determines the unit of instantaneous flow rate. When ab=00, the unit is L/S; ab=01, the unit is M ³ /H.
Reset setting of accumulated flow rate		This parameter displays in the form of “FCab”, when ab=00, then the instrument will reset the accumulated flow rate from zero after setting. But next time when it is powered on again, the accumulated flow rate will be reset too. when the value “ab” is set as any other values , the accumulate rate will not reset anymore. So if you want to reset the former accumulated flow rate and keep the later accumulated flow rate, then, set “FC00” at first then press SEL to save the setting, and press SEL and MOV simultaneously to exit the setting mode, the accumulated flow rate will be reset from zero. Then enter the setting mode again, and set this parameter as “FC01”, then save the setting and exit.
The inner password		The password for further settings, no need to set this parameter for customer. Please press SEL to next parameter or press SEL and MOV simultaneously to exit this setting mode.

The weir type number table:

Weir Type Number	Weir Type	Throat Width (ISO)	Head Height	Note
001	Parshall flume	1 in	0.21m	On the left side of the head height(highest level)is allowed values(L/S) for the display unit. Since 019,when displayed in m ³ /h to allow head height is as follows
002	Parshall flume	2 in	0.24m	
003	Parshall flume	3 in	0.33m	
004	Parshall flume	6 in	0.45m	
005	Parshall flume	9 in	0.6m	
006	Parshall flume	1 ft	0.75m	
007	Parshall flume	1ft6in	0.75m	
008	Parshall flume	2 ft	0.75m	

009	Parshall flume	2ft6in	0.75m	(more than this value,unable to display properly).	
010	Parshall flume	3 ft	0.75m		
011	Parshall flume	4 ft	0.8m		
012	Parshall flume	5 ft	0.8m		
013	Parshall flume	6 ft	0.8m		
014	Parshall flume	7 ft	0.8m		
015	Parshall flume	8 ft	0.8m		
016	Parshall flume	10 ft	1.07m		
017	Parshall flume	12 ft	1.37m		
018	Parshall flume	15 ft	1.67m		
019	Parshall flume	20 ft	1.83m		1.504m
020	Parshall flume	25 ft	1.83m		1.314m
021	Parshall flume	30 ft	1.83m		1.175m
022	Parshall flume	40 ft	1.83m	0.985m	
023	Parshall flume	50 ft	1.83m	0.84m	

Weir Type Number	Weir Type (ISO)	Head Height
101	30°triangular weir	31cm
102	45°triangular weir	31cm
103	60°triangular weir	31cm
104	90°triangular weir	31cm
105	120°triangular weir	31cm

Weir Type Number	Weir Type (ISO)	Gaps width	Head Height
201	Bordered rectangular weir	0.25m	31cm
202	Bordered rectangular weir	0.50m	46cm
203	Bordered rectangular weir	0.75m	62cm
204	Bordered rectangular weir	1.00m	62cm

Weir Type Number	Weir Type (ISO)	Gaps width	Head Height
211	Boundless rectangular weir	0.25m	31cm
212	Boundless rectangular weir	0.50m	46cm
213	Boundless rectangular weir	0.75m	62cm
214	Boundless rectangular weir	1.00m	62cm

Notes:

- Push the buttons firmly, but not too hard, to avoid damaging the circuit boards. Also, to avoid entering incorrect data, do not push the buttons too fast.
- When the instrument is used for pump control, please avoid to directly connect the relays to pump power supply circuit.
- When there is RS485 serial communication, the relay No.6 is invalid.
- The remote control can also be used to configure the parameters. There are four keys **SET**, **MOV**, **INC**, **SEL**. **MOV**, **INC** and **SEL** three keys have same functions as they are in the host panel. **SET** key is used to enter or exit the programming mode.

5. Calibration

The instrument should be calibrate indoor before installation to ensure the normal performance.

General consideration

- Let the probe be perpendicular to a wall, and make sure the measuring distance is larger than the blacking distance, and no barriers within the beam angle zone.
- Wiring and connecting the instrument correctly according to the guide .
- Turn on the power and after a few seconds the instrument will enter the running mode. And press **SEL** key to check the instantaneous flow rate, liquid level value, distance value and temperature value.
- Move the probe slowly, the level value and distance value should change slowly accordingly.
- Press **SEL** and **MOV** keys simultaneously and then enter the operating mode. Adjust the weir type number, and the installation height, then press **MOV** and **SEL** keys simultaneously to exit, then the instantaneous flow rate and level value should change accordingly, and the accumulate flow rate will increase too.
- Adjust the full scale of instantaneous flow rate, and test the output current with a multi-meter, the output current should change, too. Because the output current is always in accordance with the instantaneous flow rate.
- Adjust the status of relays, and test with a multi-meter whether the relays act in correct time delay.
- If the instrument has RS485 serial communication function, it should be tested with the host computer online.

6. Serial communication-Modbus-RTU

The serial communication is optional for ULFM O.C.M, with standard Modbus protocol, RTU serial transmission mode. (This function should be confirmed when it is ordered.)

Address number

The valid address numbers are in the range 0-247, and the address number is corresponding to the address code in Modbus communication. It can be set in the programming mode.

Baud rate

This series allows the following baud rate(RTU mode): 19200bit/s, 9600bit/s, 4800bit/s. The baud rate can be set in the programming mode.

Parity Check

Three check modes: Odd parity, even parity and no parity. The check mode can be set in the programming mode.

Function code

According to the specific application of this instrument, only one function code "03" is used, to read the read holding registers. Other Modbus function code is not valid in this instrument.

Abnormal corresponding

According to the specific application of this instrument, three abnormal data are supported in the RTU mode.

- 01: false function
- 02: false data address
- 03: false data

Electrical connection

The instrument supports the EIA/TIA-485 standard 2-wire communication link.

This instrument does not require polarity of the bias circuit.

The cable is suggested to be a pair of balanced twisted-pair cable, and shielded cable is best. When the baud rate is 9600bit / s, maximum length of the cable (AWG26 specification and above) is 1000m.

The RTU mode

The RTU frame format: the representation of data is hexadecimal byte. Each byte has 11 bits: 1 start bit, 8 data bits, 1 parity check bit, 1 stop bit, 2 stop bits when without parity check.

1) The master request:

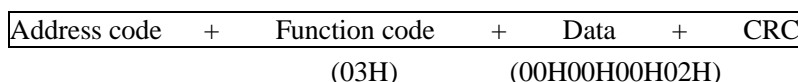

In the master request frame format, the value of "Function code" and "Data" are fixed. And the address code is the hexadecimal values of the instrument's address number.

- Address code: The address of the receiver, in RTU mode it is coded with one hexadecimal byte, which is corresponding to the decimal valid number (0-247).
- Function code: the code is "03H", because only one function code "03" is used to read the read holding registers.
- Data: the data has 4 bytes, the first 2 bytes are the address of register to read, the last 2

bytes are the number of register to read. “00H00H00H05H” means that the master requires 5 data from the first address, each data has 2 bytes, and total 10 bytes. That means the master requires: 3 bytes instantaneous flow rate, 1 byte the flow unit code, 4 bytes accumulated flow rate and 2 bytes level value.

- CRC : Cyclic Redundancy Check has 2 bytes, and the low byte first.
- For example: the master send the request as follow:
“02H 03H 00H00H 00H05H 85H0FAH”

2) **The slave response :**

Address code	+	Function code	+	Data	+	CRC
		(03H)		(0AH+10 bytes data)		

- Address code : the address of the receiver. This parameter contains one byte of information. In RTU mode it is coded with one hexadecimal byte, which is corresponding to the decimal valid number (0-247).
- Function code: the code is fixed “03H”, to send the value of the holding registers.
- Data: the data has 11 bytes, “1 byte number of data ”and “10 bytes data”.
“1 byte number of data “ is “0AH”, which means the slave returns 10 bytes values.
“10 bytes data” is “3 bytes instantaneous flow rate” and “1 byte flow rate decimal point position code” and “4 bytes accumulated flow rate” and “2 bytes level value”.
- For example: the slave response as follow
“02H 03H 0AH 00H81H9DH 02H 00H00H0AH33H 01H8AH D5HF6H”.
“02H 03H 0AH” means: the No.2 address instrument answer the response from the master, with its order to send the value of the holding registers with 10 bytes data.
“00H81H9DH” means the instantaneous flow rate is 00H81H9DH in hexadecimal, with its decimal value “33311”;
“02H” means the decimal point position is 2 digits from the bottom, so the instantaneous flow rate is 333.11, with its unit code same with its setting in programming mode.
“00H00H0AH33H” means the accumulated flow rate in hexadecimal, with its decimal value “2611”, the accumulated flow rate has one decimal point before the last digit, and its unit is “M3”, so the accumulated flow rate is “261.1M3”.
“01H8AH” means the level value in hexadecimal, with its decimal value “394”, and its unit is “mm”, so the level is 394mm.

7. Trouble-shooting

Trouble Phenomenon	Trouble Reason	Solution
The instrument does not show, and does not work.	Power supply error. Wiring error.	Check the power supply. Check the wiring.
The instrument doesn't work but with show.	The probe doesn't aim at the liquid or the material. The surface has great fluctuations. Liquid surface with lots of foam. The container is empty and the bottom is not flat.	Adjust the sensor and aim at the material. Add a tube to the container or Use the static water Wells. Add a tube to the container. Add the water and the instrument will work well.
The instrument shows unstable or the measured value has a great deviation.	Wrong setting about the weir type number or the installation height or the flow rate unit. The level enters the blanking distance. There is strong electromagnetic interference. There is Obstruction of the ultrasonic wave. There are floaters on the liquid.	Check the settings. Increase the installation height of the instrument, or prevent the level too high. Increase shielding to the instrument. Change the installation site or using a plastic tube. Eliminate floater.
The probe is fixed in circular tube	Suggest the diameter of the tube is greater than 80 mm, the length is not more than 400 mm.	

