

FEATURES

- Compact size and energy dense
- Higher voltage
- Quick charge and discharge
- RoHS & Reach compliant

APPLICATIONS

- Pulse power demand
- Ride thru power support
- Back up power
- Stand alone or augment existing energy/power source



GENERAL SPECIFICATIONS

Item	Performance
Operating temperature	-15°C to +70°C @ 3.8V -15°C to +85°C @ 3.5V
Storage temperature	-25°C to +70°C
Capacitance	10F
Capacitance tolerance	+/-20%
Rated voltage	3.8 VDC / 3.5 VDC
Minimum rated voltage	2.2 VDC
Surge voltage	4.2 VDC
Temperature characteristics	Capacitance change: Within ±50% of initial measured value at +25°C (-15°C to +70°C) Internal resistance: Within ±800% of initial measured value at +25°C (at -15°C)
Endurance (At rated voltage & max. operating temp)	After 1000 hours: Capacitance change: ±30% of initial rated value Internal resistance: Within 2 times of initial specified value
Projected cycle life (From rated voltage to 1/2 rated voltage at 25°C)	After 500,000 cycles: Capacitance change: Within ±30 % of initial rated value Internal resistance: Within 2 times of initial specified value
Shelf life	After 1000 hours storage, at 70°C without load, the capacitor shall meet the specified endurance limits.

DIMENSIONS

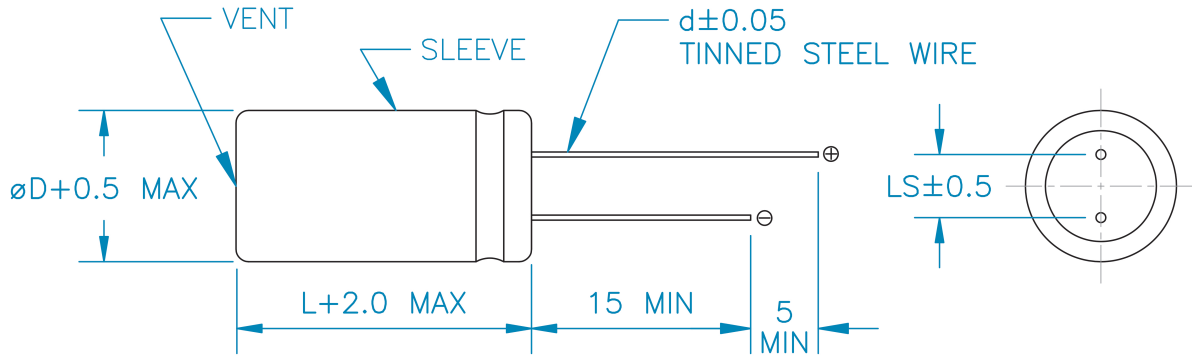

STANDARD PRODUCTS

Part Number	UL	Nom. Cap. (F)	ESR AC (mΩ) (1 KHz)	ESR DC Typical (mΩ)	Leakage Current (mA)	Dimensions (mm)				Rated Current (A)	Max Current (A)	Weight/Unit (grams)
						D	L	d	LS			
TPLC-3R8/10MR8X14		10	500	1500	0.001	8	14	0.6	3.5	0.05	0.5	1.9