

CVT10 Pro

Fiber Converter



Specifications

Change History

Document Version	Release Date	Description
V1.0.0	2022-08-01	First release

Introduction

The CVT10 Pro fiber converter offers a way to convert optical signals to electrical signals, or electrical signals to optical signals, for connecting the sending card to the LED screen. Delivering a full-duplex, efficient and stable data transmission that is not easily interfered with, this converter is ideal for long-distance transmission.

The CVT10 Pro adopts a dustproof and waterproof design. It can be mounted horizontally in a rack, or mounted onto a scaffold in a suspended way with truss clamps, which is easy, secure and reliable.

Certifications

CE, FCC, IC, UL, CB, RCM

If the product does not have the relevant certifications required by the countries or regions where it is to be sold, please contact NovaStar to confirm or address the problem. Otherwise, the customer shall be responsible for the legal risks caused or NovaStar has the right to claim compensation.

Features

- Models include the CVT10 Pro-S (single-mode) and the CVT10 Pro-M (multi-mode).
- 2x optical ports with hot-swappable optical modules installed at the factory, bandwidth of each up to 10 Gbit/s
- 10x Gigabit Ethernet ports, bandwidth of each up to 1 Gbit/s
 - Fiber in and Ethernet out
If the input device has 8 or 16 Ethernet ports, the first 8 Ethernet ports of the CVT10 Pro are available.
If the input device has 10 or 20 Ethernet ports, all the 10 Ethernet ports of the CVT10 Pro are available. If Ethernet ports 9 and 10 are found unavailable, they will be available after upgrading in the future.
 - Ethernet in and fiber out
All the 10 Ethernet ports of the CVT10 Pro are available.
- 1x type-B USB control port

Appearance

Front Panel





Name	Description
PWR	Power indicator Always on: The power supply is normal.
STAT	Running indicator Flashing: The device is functioning normally.
OPT1/OPT2	Optical port indicators Always on: The optical fiber connection is normal.
1–10	Ethernet port indicators Always on: The Ethernet cable connection is normal.
CVT	Working mode indicator Always on: The device is in fiber converter mode. OPT 1 is the primary port and OPT 2 is the backup port.
DIS	Reserved

Rear Panel

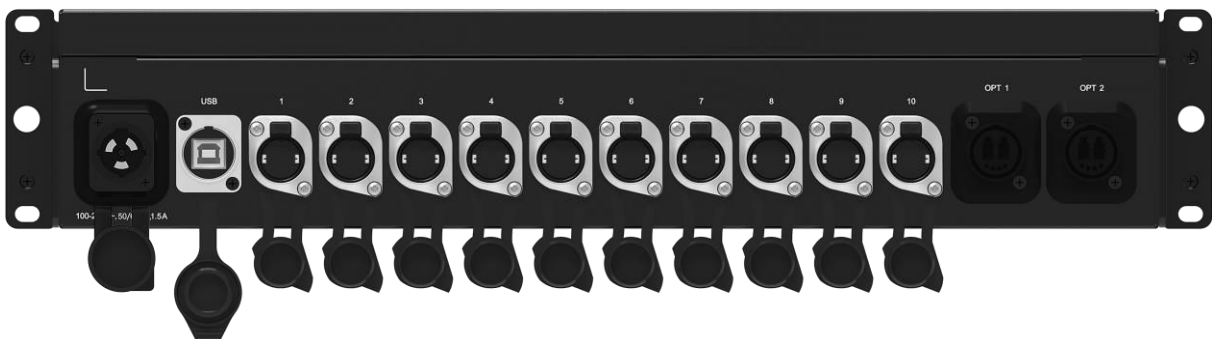

Name	Description
100-240V~, 50/60Hz, 1.5A	Power input connector (PowerCON) For the PowerCON connector, users are not allowed to plug in hot. Pour le connecteur PowerCON, les utilisateurs ne sont pas autorisés à se connecter à chaud.
USB	Type-B USB control port Connect to the control computer (NovaLCT V5.4.0 or later) for upgrading the CVT10 Pro program, not for cascading.
1–10	Gigabit Ethernet ports
OPT1/OPT2	10G optical ports OPT 1 is the primary port and OPT 2 is the backup port.

Name	Description	
	CVT10 Pro-S optical module description: <ul style="list-style-type: none"> • Hot swappable • Transmission rate: 9.95 Gbit/s to 11.3 Gbit/s • Wavelength: 1310 nm • Transmission distance: 10 km 	CVT10 Pro-S optical fiber selection: <ul style="list-style-type: none"> • Model: OS1/OS2 • Transmission mode: Single-mode twin-core • Cable diameter: 9/125 μm • Connector type: LC • Insertion loss: ≤ 0.3 dB • Return loss: ≥ 45 dB
	CVT10 Pro-M optical module description: <ul style="list-style-type: none"> • Hot swappable • Transmission rate: 9.95 Gbit/s to 11.3 Gbit/s • Wavelength: 850 nm • Transmission distance: 300 m 	CVT10 Pro-M optical fiber selection: <ul style="list-style-type: none"> • Model: OM3/OM4 • Transmission mode: Multi-mode twin-core • Cable diameter: 50/125 μm • Connector type: LC • Insertion loss: ≤ 0.2 dB • Return loss: ≥ 45 dB

Dimensions

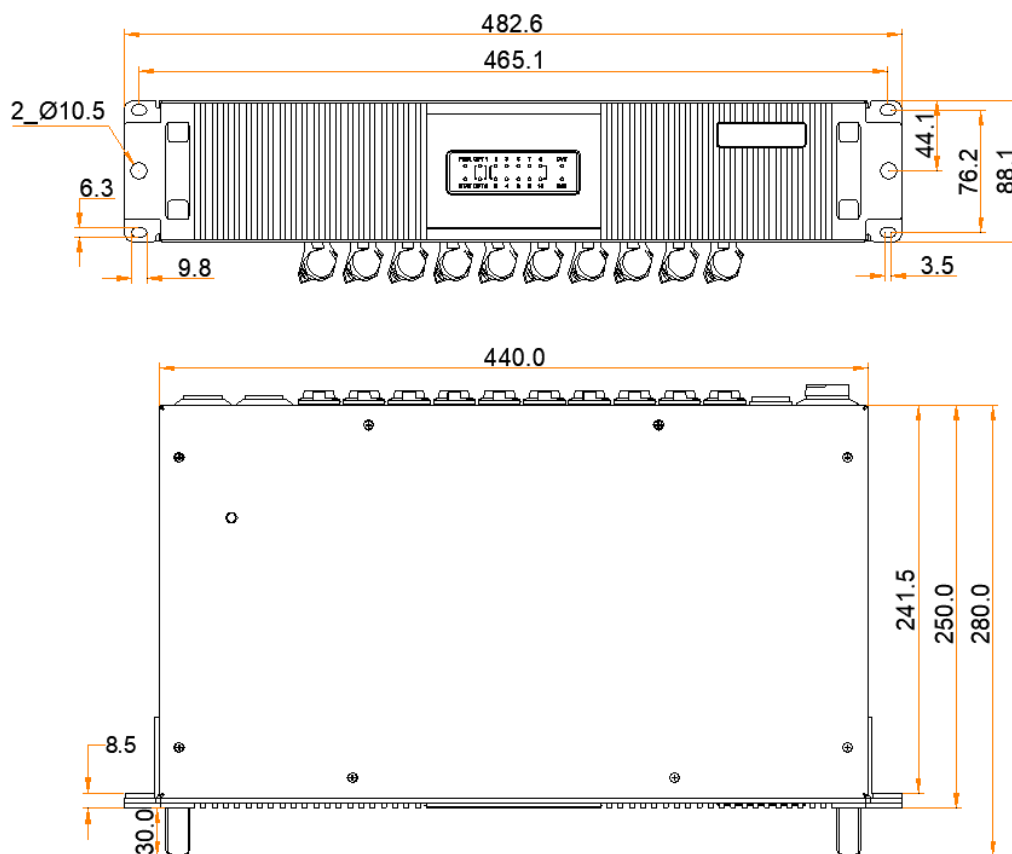

Tolerance: ± 0.3 Unit: mm

Applications

The CVT10 Pro is used for long-distance data transmission. Users can decide a connection method based on whether the sending card has optical ports.

The Sending Card Has Optical Ports

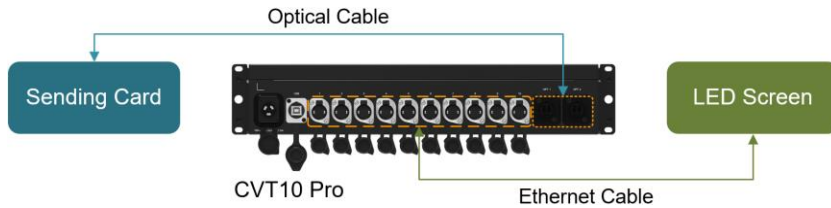

The Sending Card Has No Optical Ports

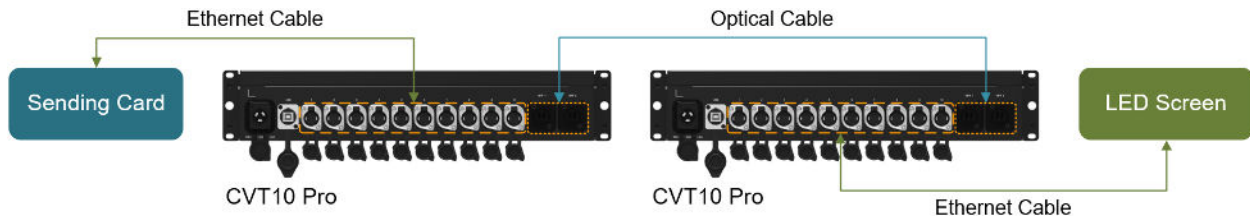

Specifications

Electrical Specifications	Power supply	100-240V~, 50/60Hz, 1.5A
	Rated power consumption	22 W
Operating Environment	Temperature	-20°C to +55°C
	Humidity	10% RH to 80% RH, non-condensing
Storage Environment	Temperature	-20°C to +70°C
	Humidity	10% RH to 95% RH, non-condensing
Physical Specifications	Dimensions	482.6 mm × 88.1 mm × 280.0 mm
	Net weight	5.9 kg
	Gross weight	7.8 kg Note: It is the total weight of the product, accessories, and packing materials packed according to the packing specifications.
Packing Information	Carrying case	535.0 mm × 199.0 mm × 430.0 mm, white cardboard box
	Packing box	550.0 mm × 440.0 mm × 215.0 mm, kraft paper box
	Accessories	1x Power cord 1x USB cable 1x Certificate of Approval
IP Rating	IP65	

The amount of power consumption may vary depending on various factors such as product settings, usage, and environment.

Notes and Cautions

Notes for Installation

Caution: The equipment must be installed in a restricted access location.

Attention: L'équipement doit être installé dans un endroit à accès restreint.

When the product needs to be installed on the rack, 4 screws at least M5*12 should be used to fix it. The rack for installation shall bear at least 25kg weight.

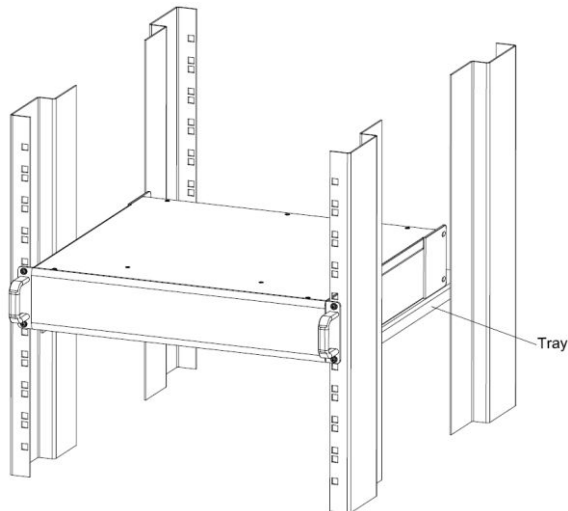

- Elevated Operating Ambient - If installed in a closed or multi-unit rack assembly, the operating ambient temperature of the rack environment may be greater than room ambient. Therefore, consideration should be given to installing the equipment in an environment compatible with the maximum ambient temperature (T_{ma}) specified by the manufacturer.
- Reduced Air Flow – Installation of the equipment in a rack should be such that the amount of air flow required for safe operation of the equipment is not compromised.
- Mechanical Loading – Mounting of the equipment in the rack should be such that a hazardous condition is not achieved due to uneven mechanical loading.
- Circuit Overloading – Consideration should be given to the connection of the equipment to the supply circuit and the effect that overloading of the circuits might have on overcurrent protection and supply wiring. Appropriate consideration of equipment nameplate ratings should be used when addressing this concern.
- Reliable Earthing – Reliable earthing of rack-mounted equipment should be maintained. Particular attention should be given to supply connections other than direct connections to the branch circuit (e.g. use of power strips).

When mounting the product in a suspended way, use $\phi 10\text{mm}$ bolts for the truss clamps.

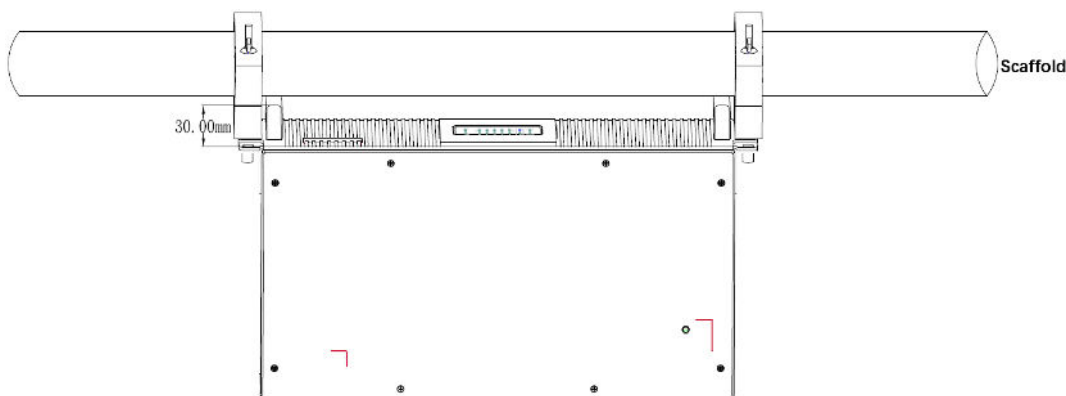

FCC Caution

Any changes or modifications not expressly approved by the party responsible for compliance could void the user's authority to operate the equipment.

This device complies with part 15 of the FCC Rules. Operation is subject to the following two conditions: (1) This device may not cause harmful interference, and (2) this device must accept any interference received, including interference that may cause undesired operation.

Note: This equipment has been tested and found to comply with the limits for a Class A digital device, pursuant to part 15 of the FCC Rules. These limits are designed to provide reasonable protection against harmful interference when the equipment is operated in a commercial environment. This equipment generates, uses, and can radiate radio frequency energy and, if not installed and used in accordance with the instruction manual, may cause harmful interference to radio communications. Operation of this equipment in a residential area is likely to cause harmful interference in which case the user will be required to correct the interference at his own expense.

Others

This is Class A product. In a domestic environment, this product may cause radio interference in which case the user may be required to take adequate measures.

Copyright © 2022 Xi'an NovaStar Tech Co., Ltd. All Rights Reserved.

No part of this document may be copied, reproduced, extracted or transmitted in any form or by any means without the prior written consent of Xi'an NovaStar Tech Co., Ltd.

Trademark

 is a trademark of Xi'an NovaStar Tech Co., Ltd.

Statement

Thank you for choosing NovaStar's product. This document is intended to help you understand and use the product. For accuracy and reliability, NovaStar may make improvements and/or changes to this document at any time and without notice. If you experience any problems in use or have any suggestions, please contact us via the contact information given in this document. We will do our best to solve any issues, as well as evaluate and implement any suggestions.

| [Official website](http://www.novastar.tech)
| www.novastar.tech

| [Technical support](mailto:support@novastar.tech)
| support@novastar.tech