



NEO



Solar Mounting Solutions

Mount Bracket

Culture

Mission:

- Adhere to innovation
- To meet customers' requirements
- To win global market
- To keep excellent and professional
- To build first-class green energy brand

Value:

- Communication
- Win-win Benefits
- Cooperation,
- Service
- Competition

Spirit:

- Professional focus
- Full participation;
- Great unity,
- Open and profound mind

Vision:

- Sincere credibility and top-level of service
- Scientific standard and high-quality of products

The First Sun



Pantile Mount Side Fixing

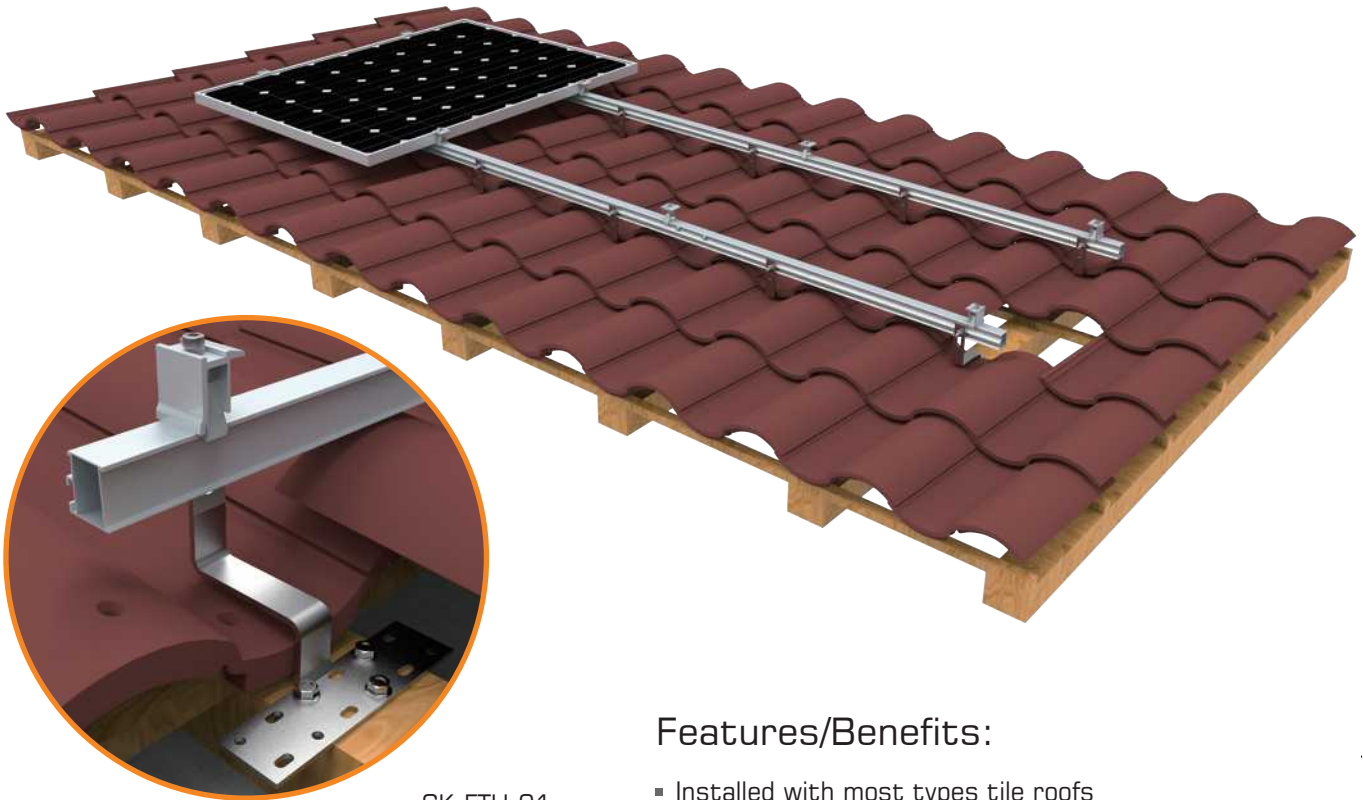

CK-FTH-01

Features/Benefits:

- Installed with most types tile roofs
- Portrait & Landscape orientation
- Pre-assembled
- Made of SUS 304
- Height adjustable
- Easy installation



Portrait Orientation

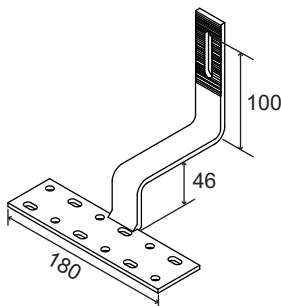

CK-FTH-01

Landscape Orientation

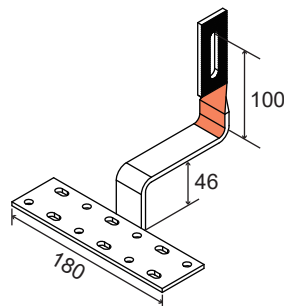

CK-FTH-01B

Height Adjustable

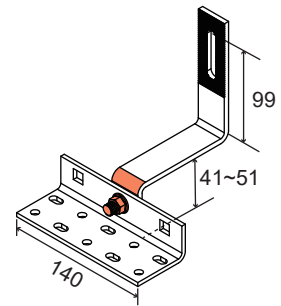

CK-FTH-09

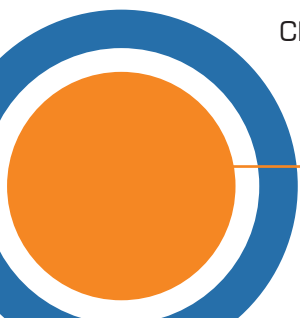

Pantile Mount Bottom Fixing

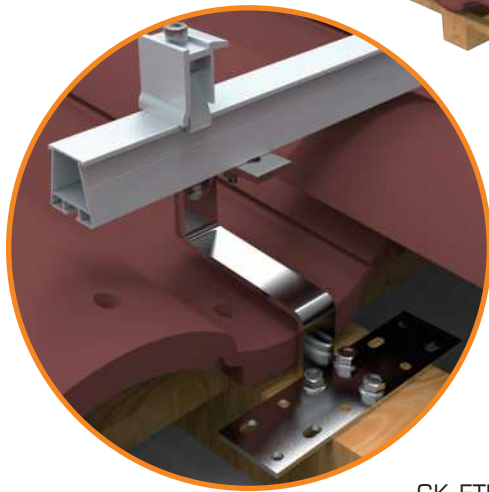
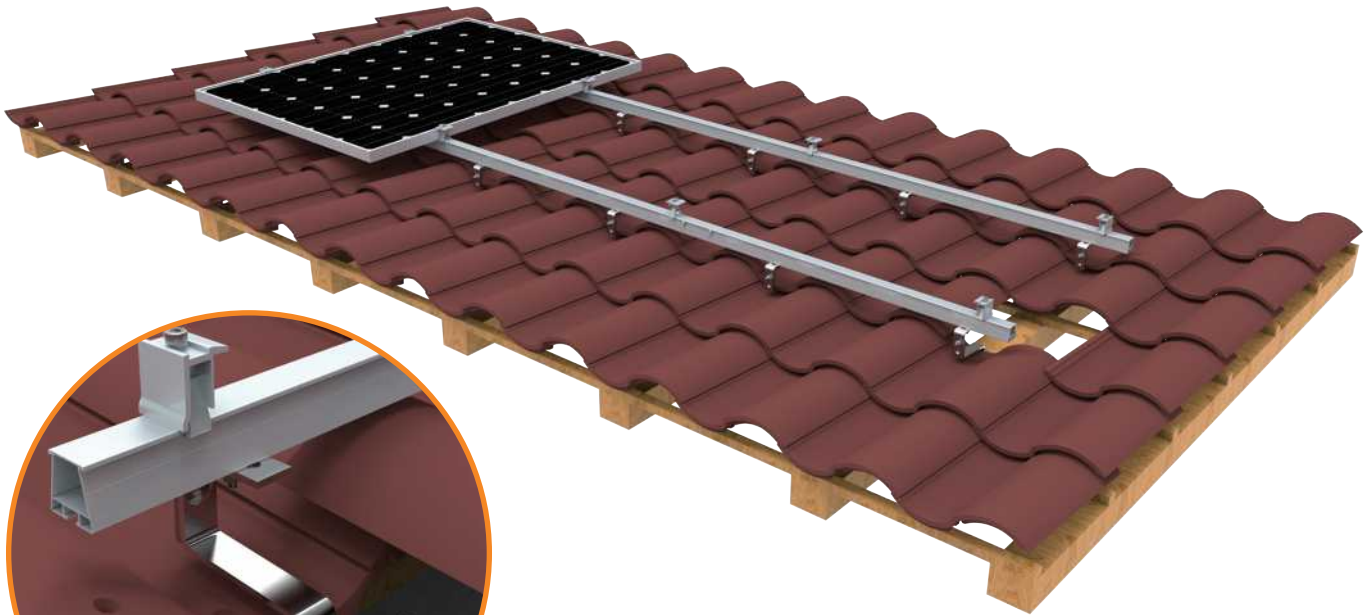

CK-FTH-073

Features/Benefits:

- Installed with most types tile roofs
- Portrait & Landscape orientation
- Pre-assembled
- Made of SUS 304
- Height adjustable
- Easy installation
- Firmly bottom fixing



Height adjustable over tile

Height adjustable at batten

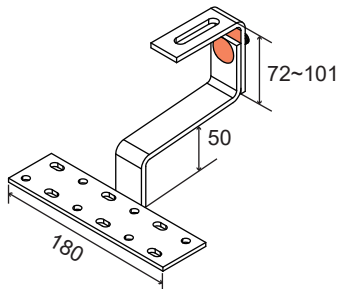

CK-FTH-073

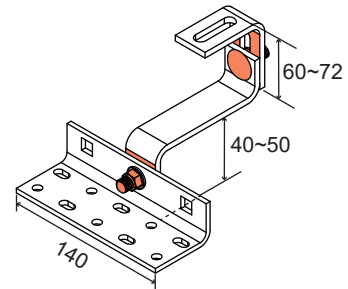

CK-FTH-09V

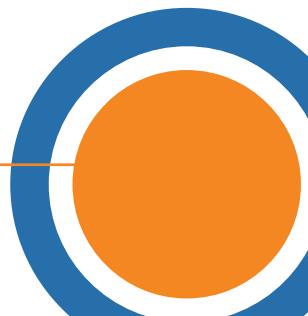

Flat Tile Mount

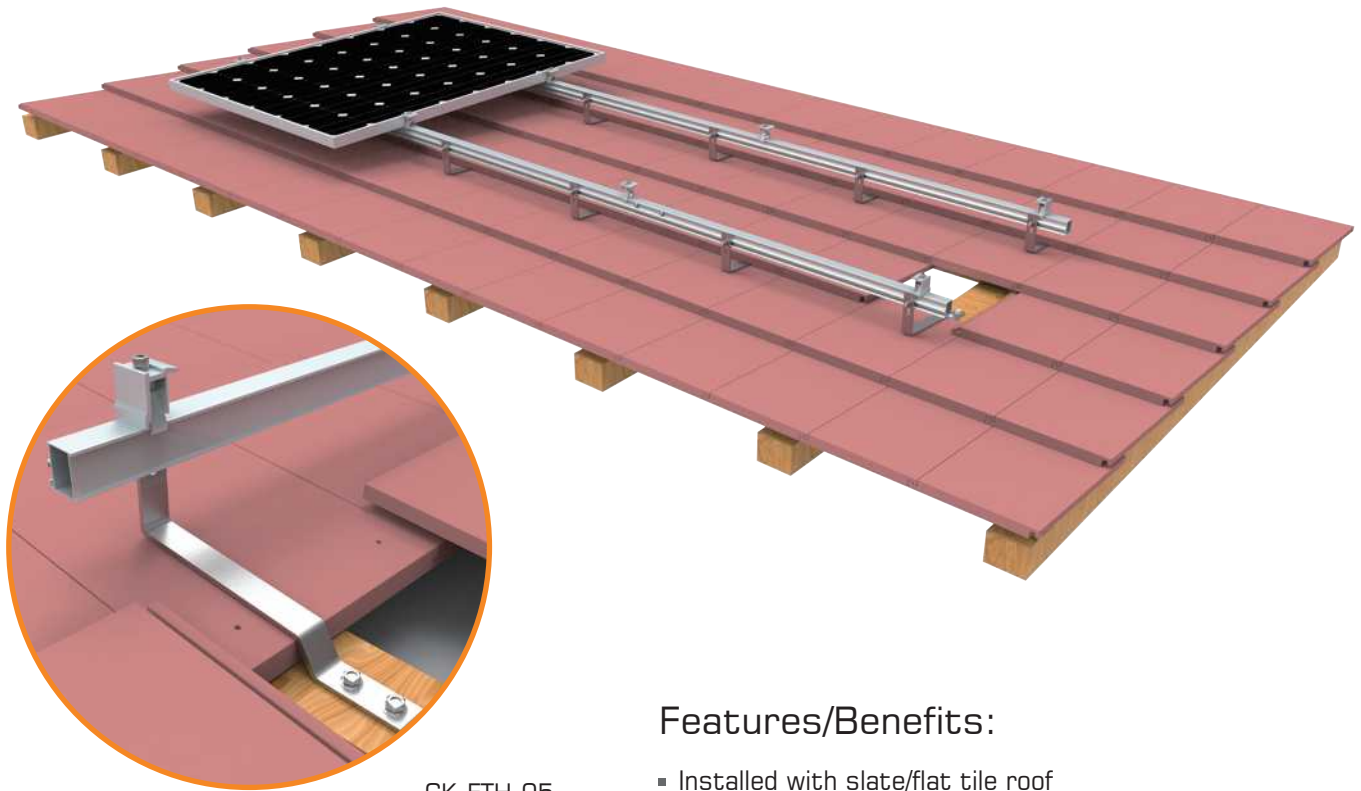

CK-FTH-05

Features/Benefits:

- Installed with slate/flat tile roof
- Portrait & Landscape orientation
- Pre-assembled
- Made of SUS 304
- Height adjustable
- Easy installation



Portrait orientation

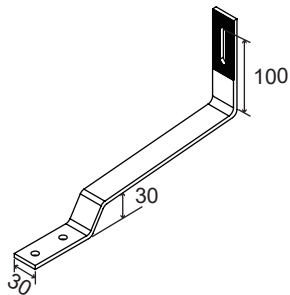

CK-FTH-05

Landscape orientation

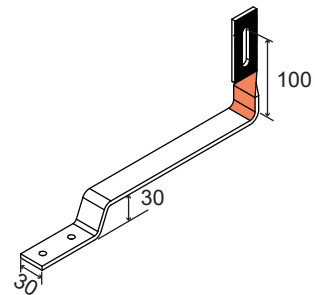

CK-FTH-05B

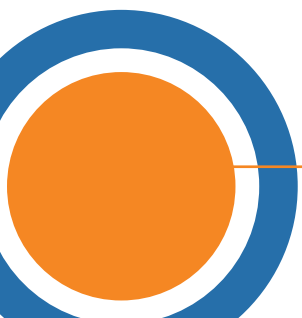

Crown Mount

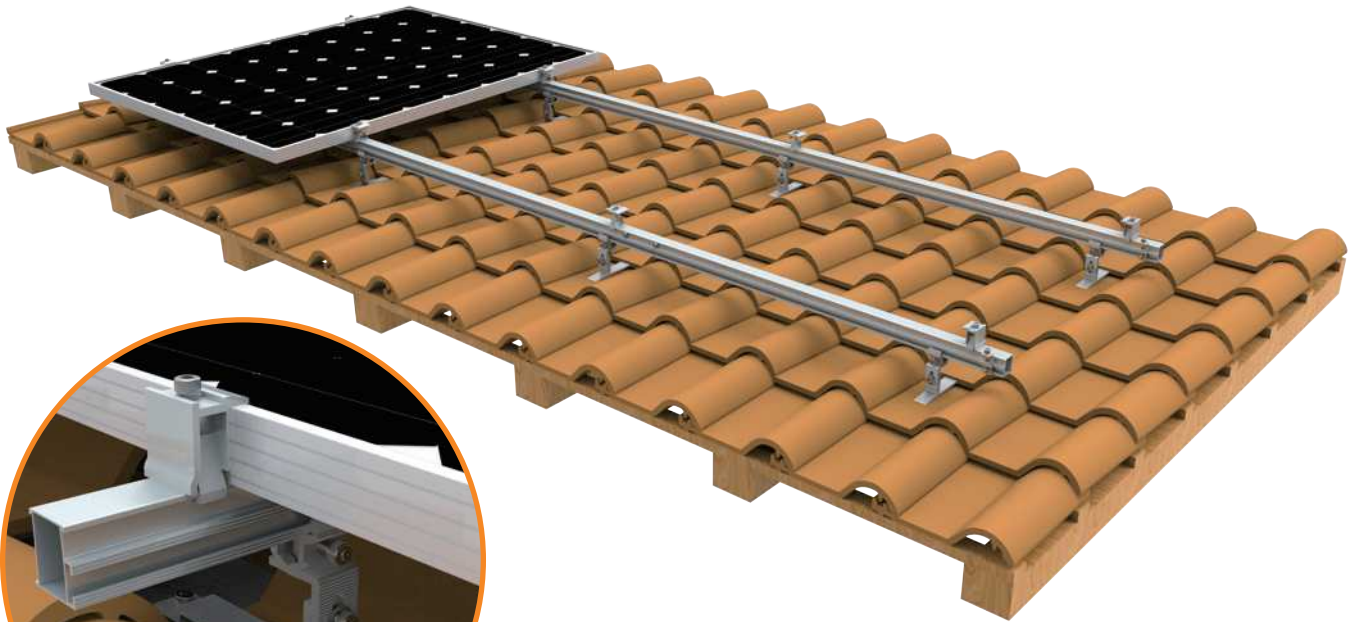

CK-FTS-385

Features/Benefits:

- Bottom carrying of rail achieved easily by side fastening
- Module orientation switched easily by rotatable adapter
- Made of AL 6005-T5
- High-class surface anodizing
- Pre-assembled
- Height adjustable



Tulip Mount

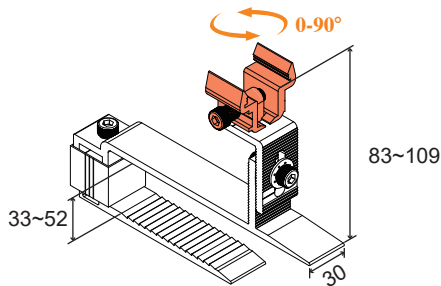

CK-FTS-385

Arc Mount

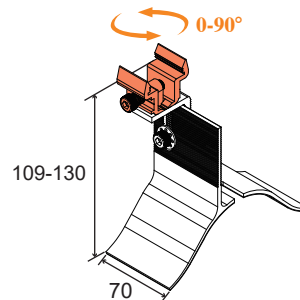

CK-FTS-360

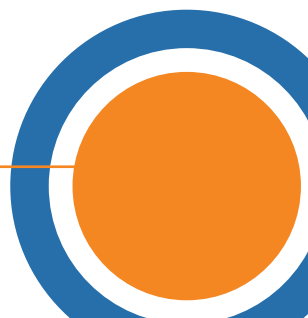

Asphalt Shingle Mount

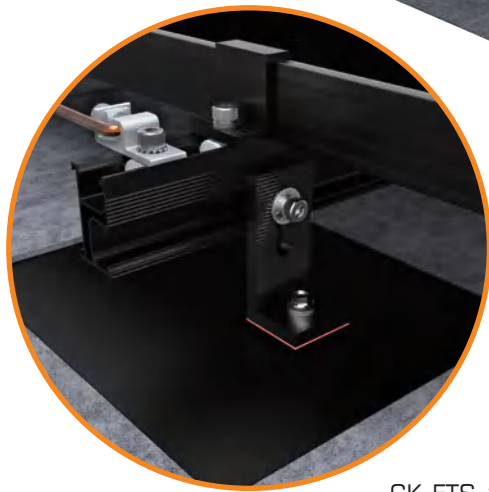

CK-FTS-162T2-5



Features/Benefits:

- Installed with Asphalt Shingle Roof
- Portrait and Landscape orientation
- Made of AL 6005-T5
- High-class surface anodizing
- Pre-assembled
- Waterproof silicon rubber and flashing integrated
- Easy installation

Specifications

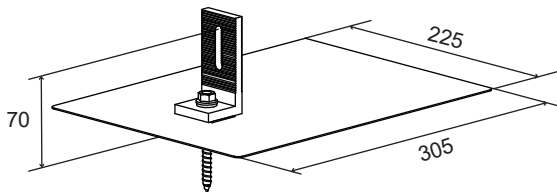

Waterproofing

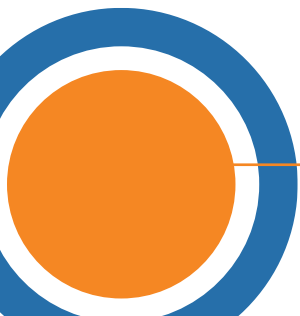
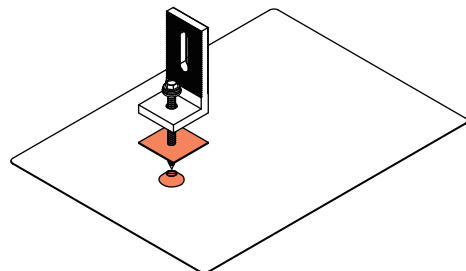

Standoff Mount

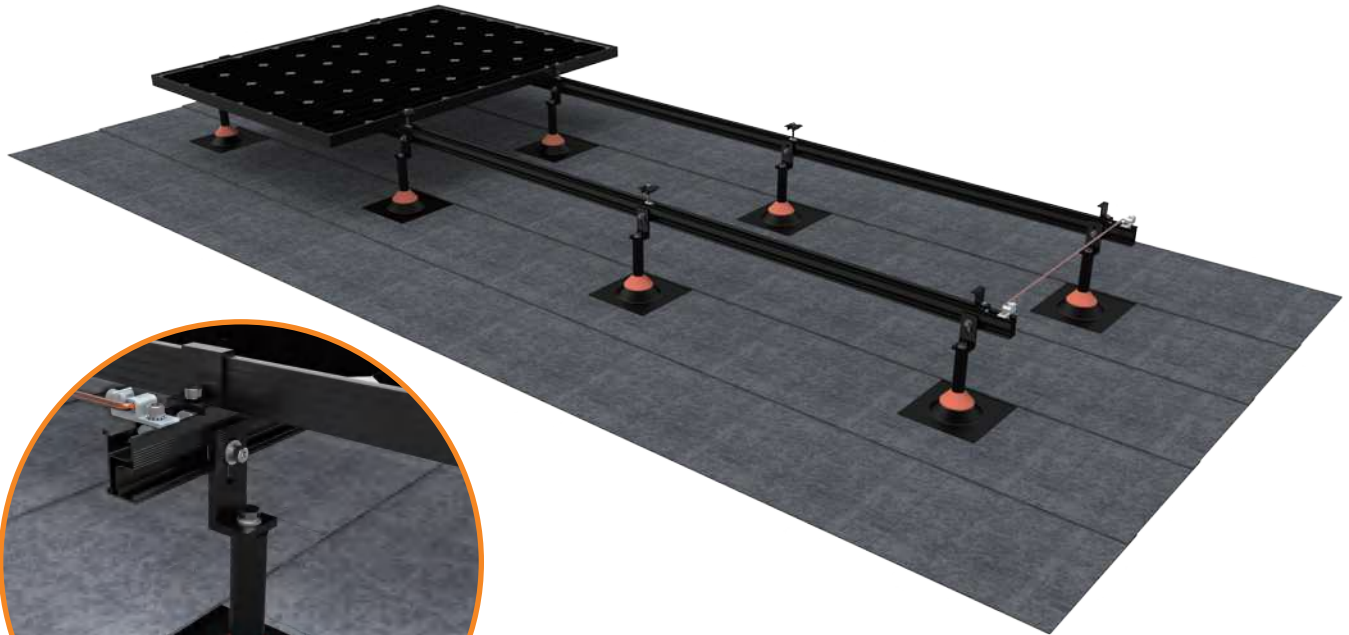

CK-FTS-162T2-3

Features/Benefits:

- Installed with any type flat roof
- Portrait and Landscape orientation
- Made of AL 6005-T5
- High-class surface anodizing
- Pre-assembled
- Waterproof silicon rubber and flashing integrated
- Different Height available
- Easy installation





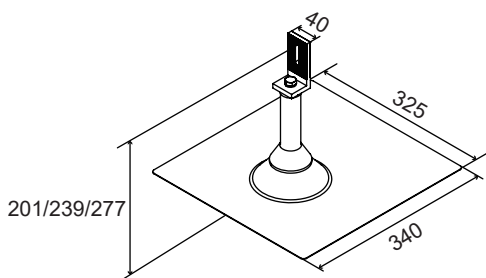



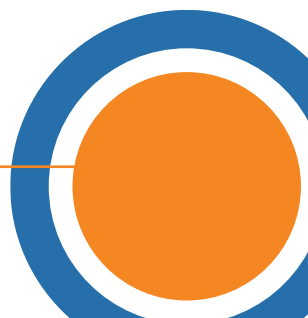
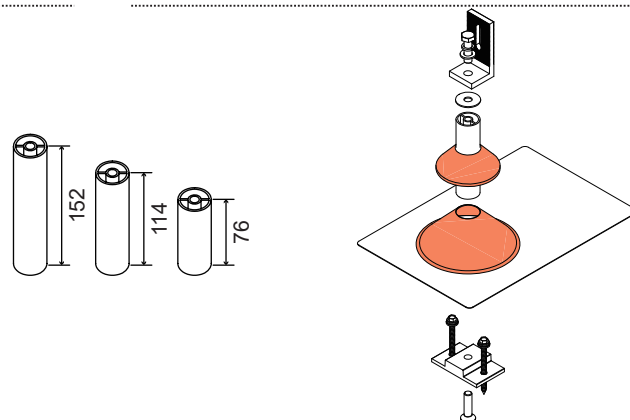



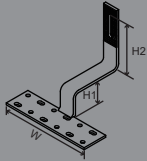
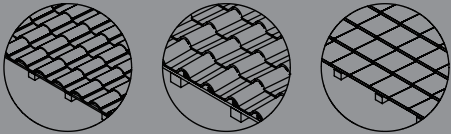

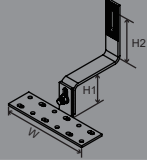
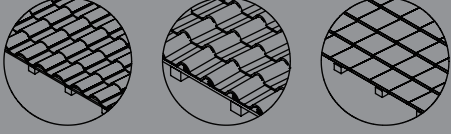
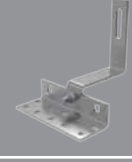
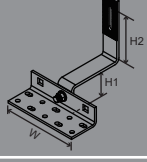
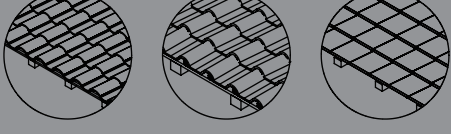
Height Options

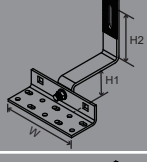
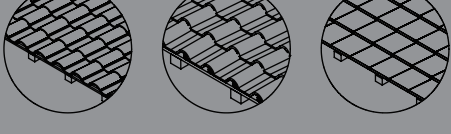

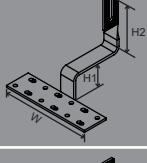
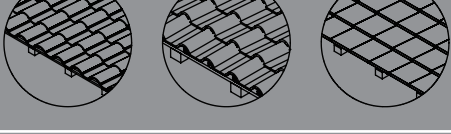

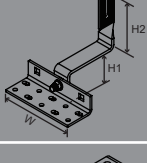
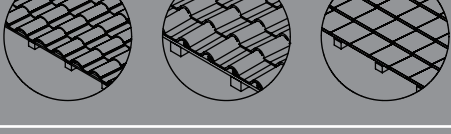

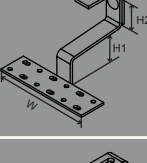
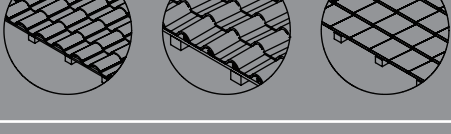

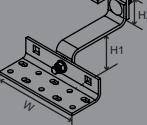
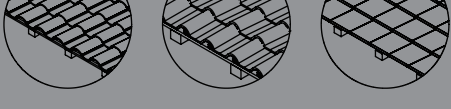

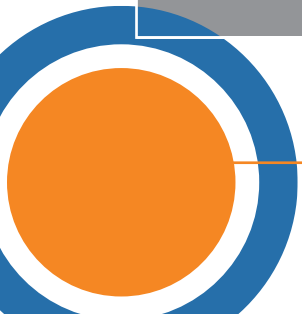

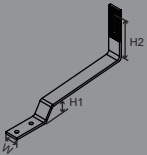
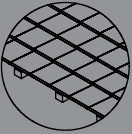

Waterproofing

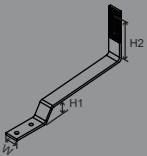
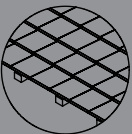

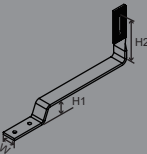
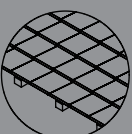
Stainless Steel Hook

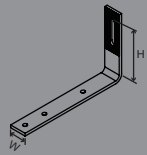
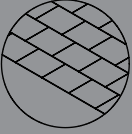
Type No.	Image	Technical	Dimensions	Tile Roof Type
CK-FTH-01			H1=46 H2=100 W=180	
CK-FTH-78			H1=66~98 H2=101 W=180	
CK-FTH-09			H1=41~51 H2=99 W=140	
CK-FTH-79			H1=41~51 H2=99 W=140	
CK-FTH-01B			H1=46 H2=100 W=180	
CK-FTH-09B			H1=41~51 H2=99 W=140	
CK-FTH-73			H1=50 H2=72~101 W=180	
CK-FTH-09V			H1=40~50 H2=60~72 W=140	

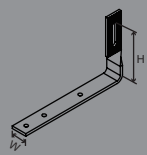
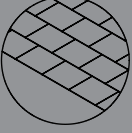

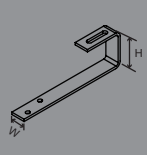
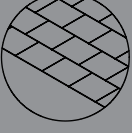
Type No.	Image	Technical	Dimensions	Tile Roof Type
CK-FTH-05			H1=30 H2=100 W=30	
CK-FTH-81			H1=30 H2=100 W=30	
CK-FTH-05B			H1=30 H2=100 W=30	
CK-FTH-07			H=101 W=30	
CK-FTH-07B			H=101 W=30	
CK-FTH-61			H=75 W=30	

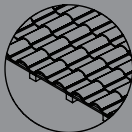
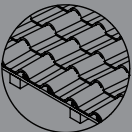
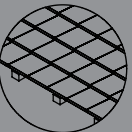
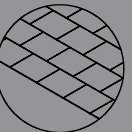
Pantile	Roman tile	Flat tile	Asphalt Shingle
			

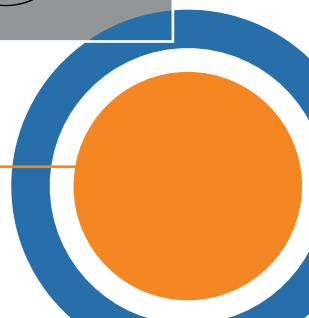

L Feet Mount

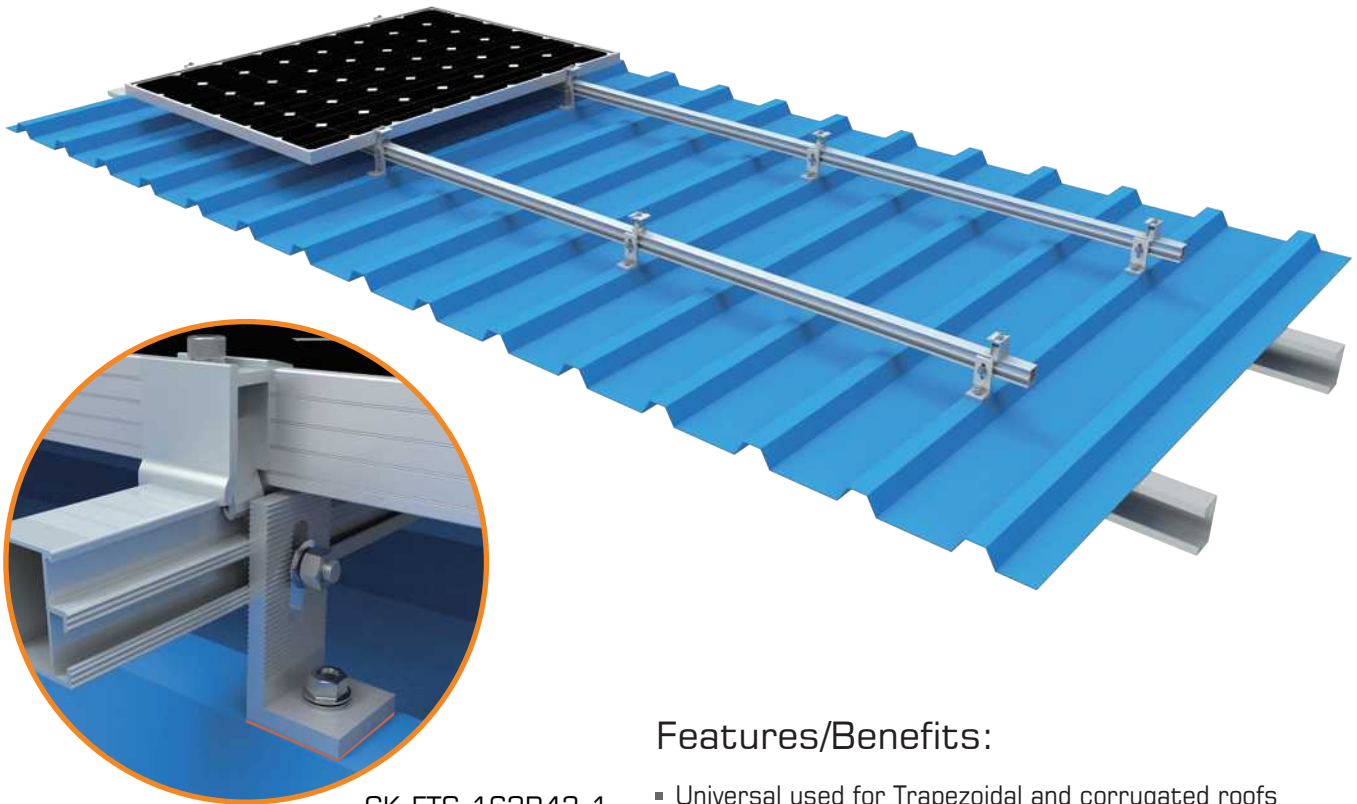

CK-FTS-162R43-1

Features/Benefits:

- Universal used for Trapezoidal and corrugated roofs
- Portrait or Landscape orientation
- Pre-assembled
- Made of high class material AL6005-T5
- Pre-Applied EPDM pad



Length Options

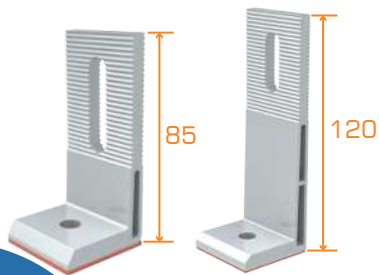

Apply with Hanger Bolt



Work with roof clamps

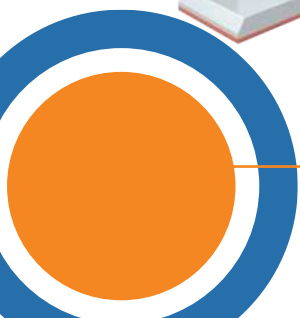
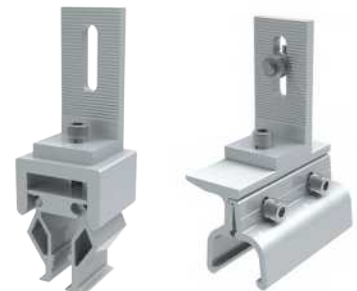

Hanger Bolt Mount

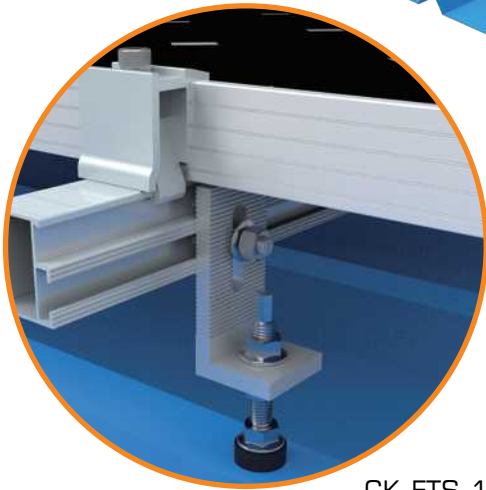
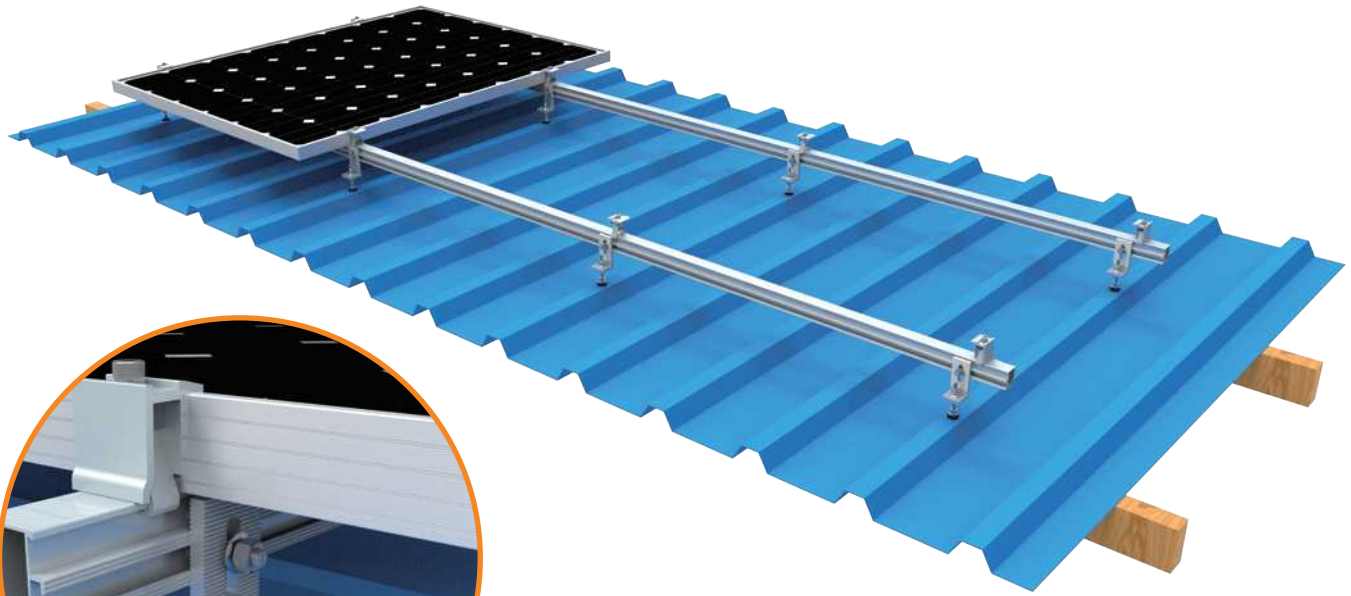

CK-FTS-162R43-7

Features/Benefits:

- Universal used for fibre-cement, trapezoidal and corrugated roofs
- Portrait or Landscape orientation
- Pre-assembled
- Made of high class material AL6005-T5
- Height adjustable and help to increase power generation



For Wooden Rafter

For Steel Purlin

Combined with Alu Plate



CK-HS-003-B1200/250/300



CK-HS-001-C120/160/200

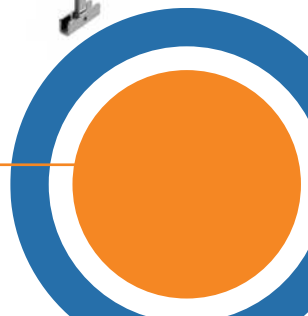

Trapezoidal Clamp Mount

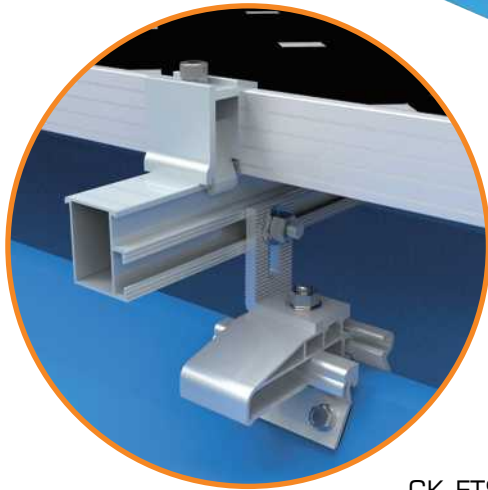
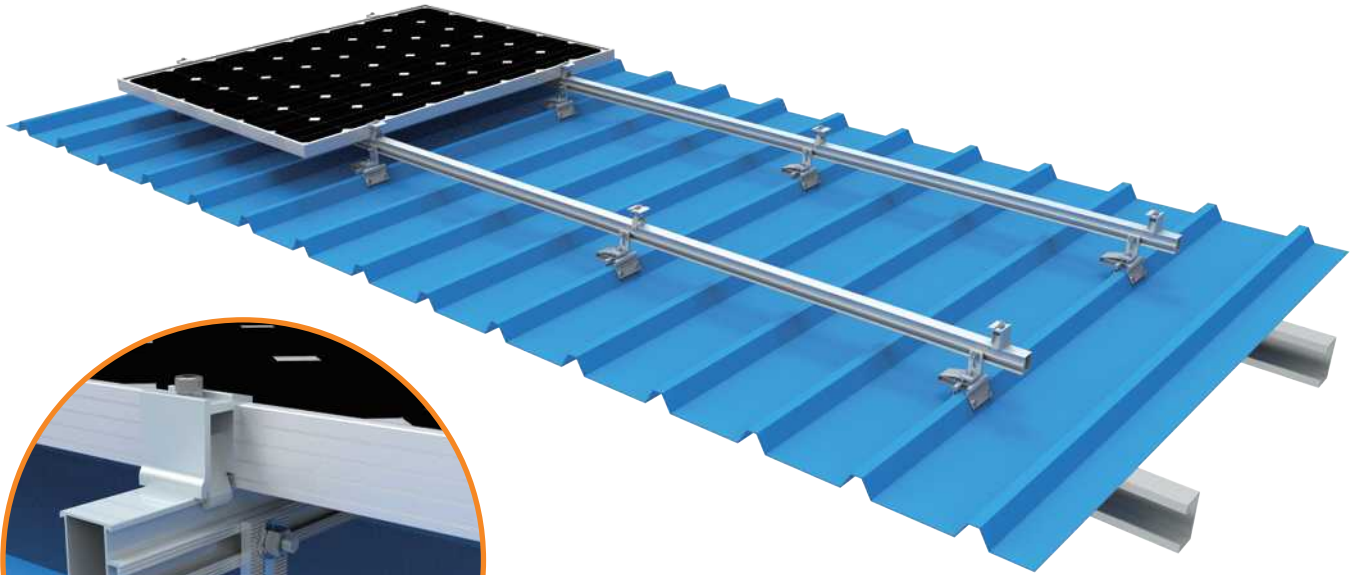

CK-FTS-384

Features/Benefits:

- Application on the trapezoidal roof profile
- Portrait or Landscape orientation
- Made of high class material AL6005-T5
- Every size of module array possible
- Components configured completely, no need extra parts purchasing
- Share the roof loading



Top Drilling

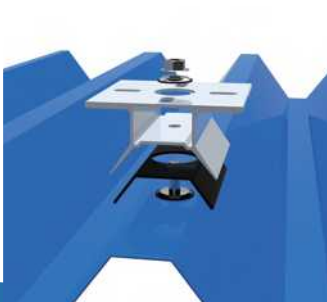

CK-FTS-320



CK-FTS-352

Side Drilling



CK-FTS-381



CK-FTS-395

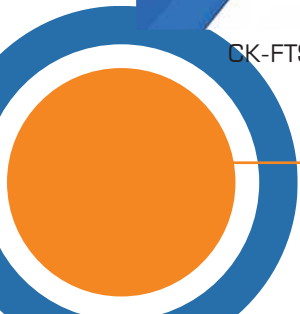

Rail-Free Mount

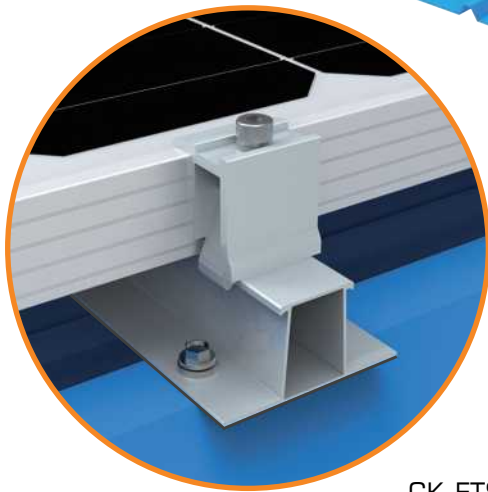
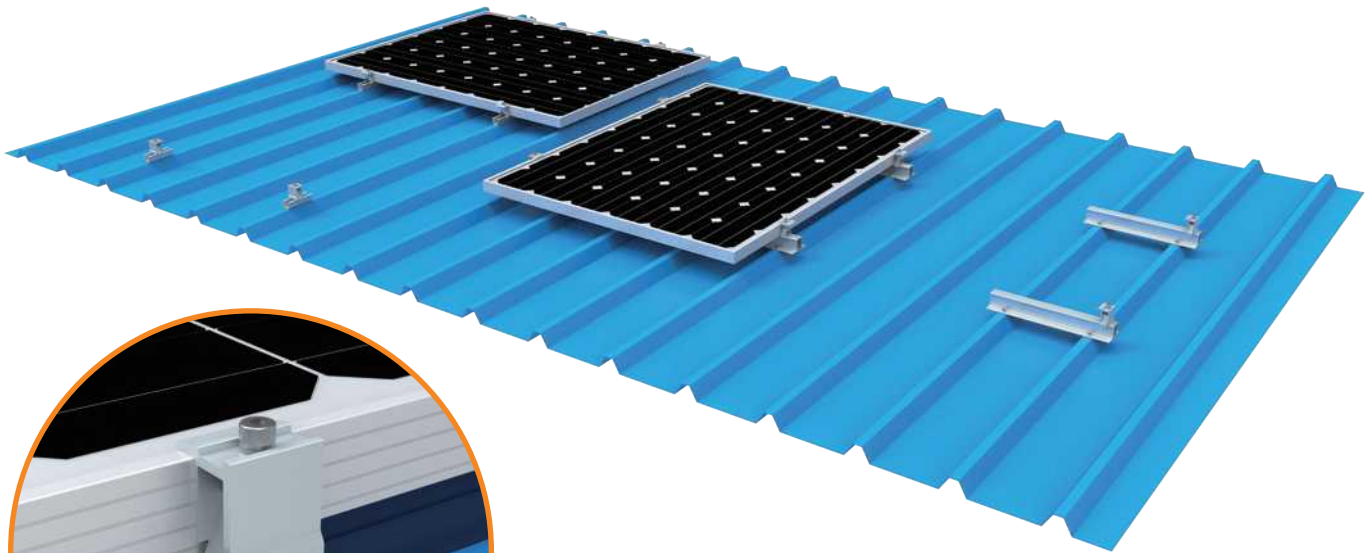

CK-FTS-017

Features/Benefits:

- Application on the trapezoidal and Sandwich roof profile
- Portrait orientation
- Made of high class material AL6005-T5
- Lower Costing & Fast fixing
- Fix on ribs only ,no need drill purlin
- Pre-assembled with EPDM pad



Different height for option

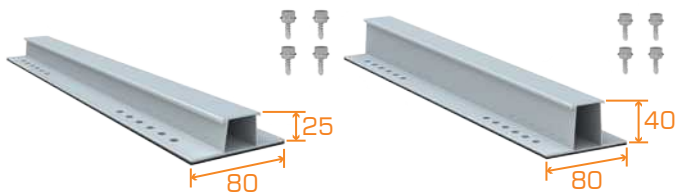

CK-FTS-016

CK-FTS-017

Portrait&Landscape Orientation



CK-FTS-022

CK-FTS-012

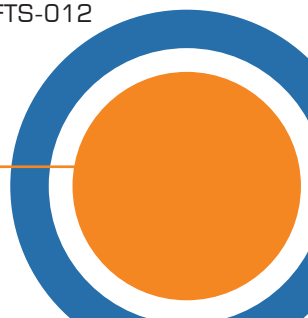

Lysaght Klip-lok Mount

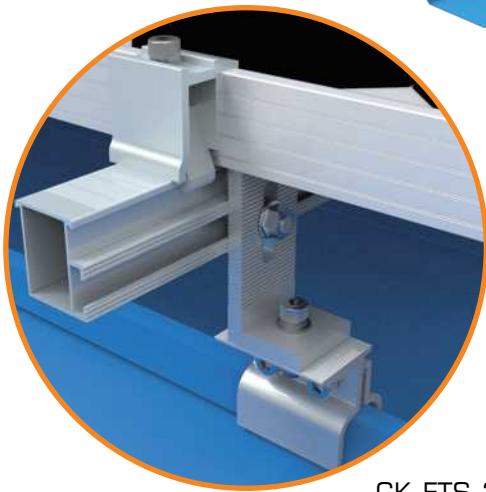
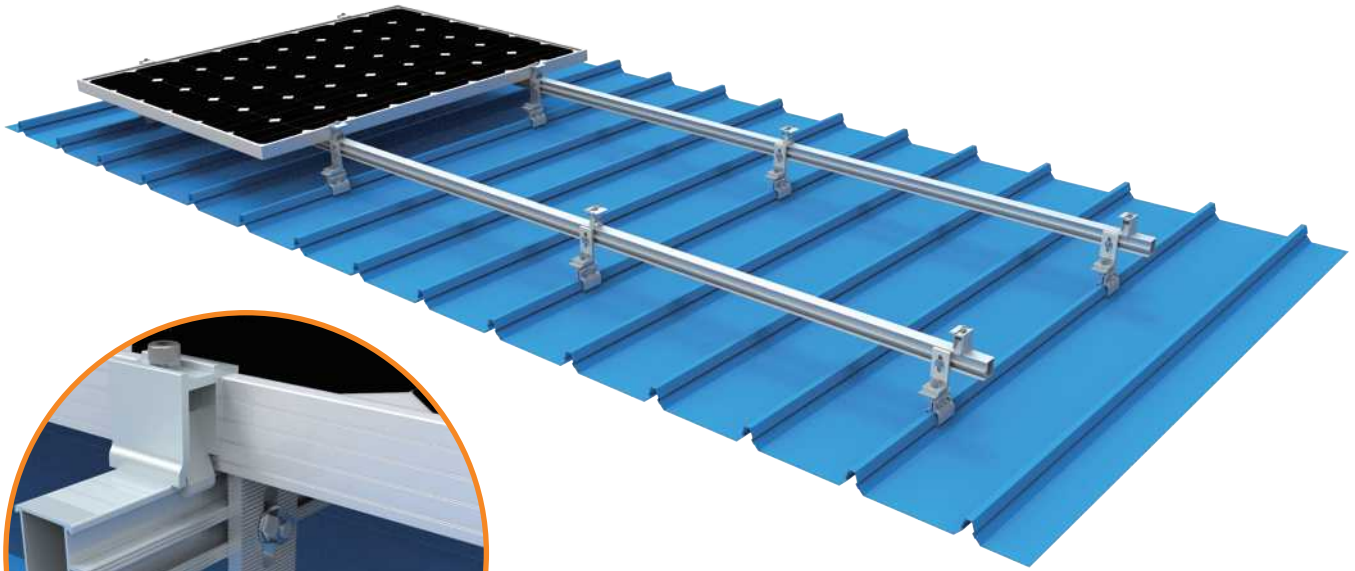

CK-FTS-370/371

Features/Benefits:

- Application on the Lysaght Klip-lok 406 & 700
- Portrait or Landscape orientation
- Made of high class material AL6005-T5
- Every size of module array possible
- Share the roof loading
- Non-penetration installation



Klip-lok Series



CK-FTS-370



CK-FTS-351



CK-FTS-336

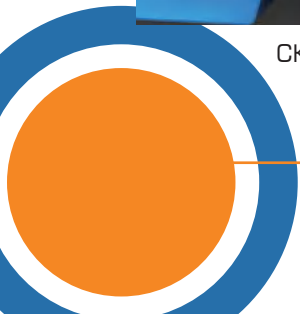

E-LOCK Mount

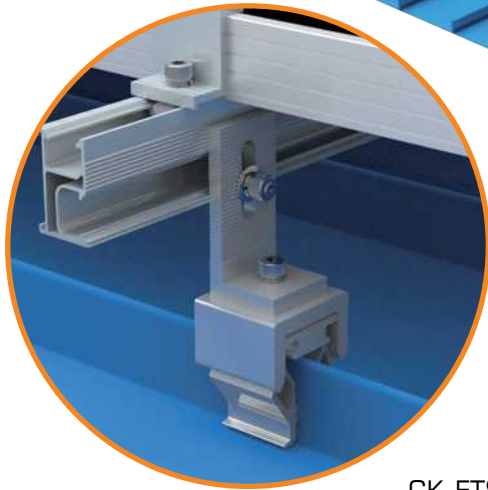
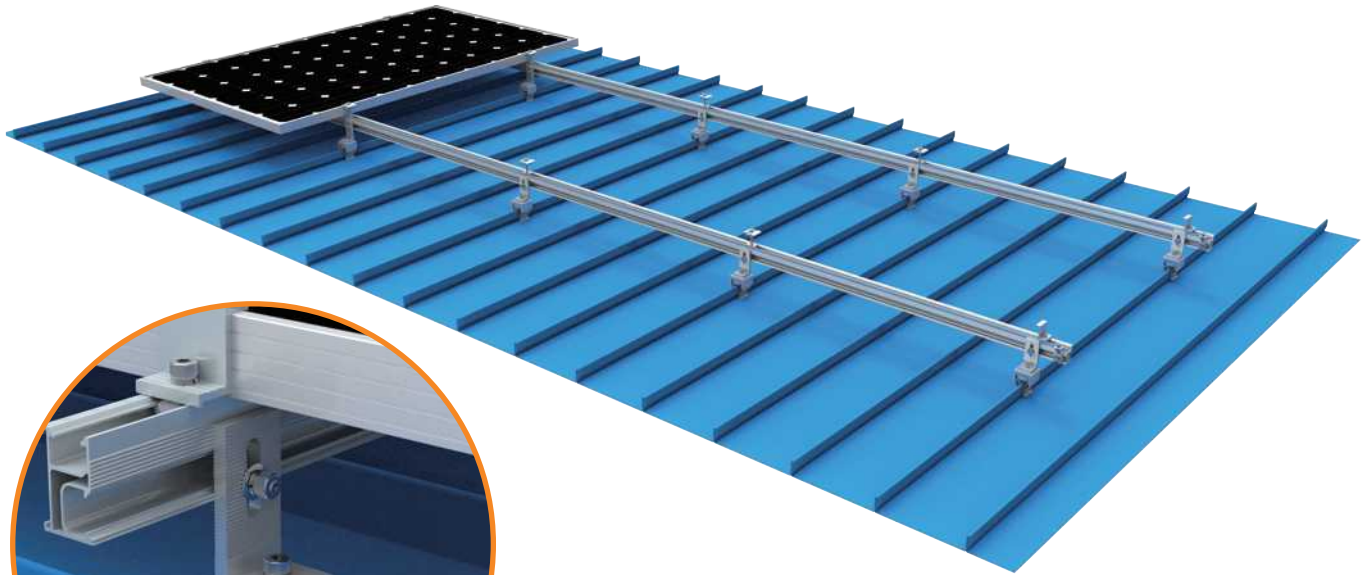

CK-FTS-388

Features/Benefits:

- Used on different seam roofs
- Portrait and Landscape orientation
- Made of high class material AL6005-T5
- One bolts fixing ,saving installation time and process
- Unique design with non-penetrating solutions



Customized Shapes For Roofing Profiles



CK-FTS-389



CK-FTS-376



CK-FTS-388

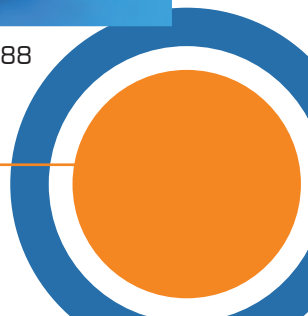

Tilt Mount

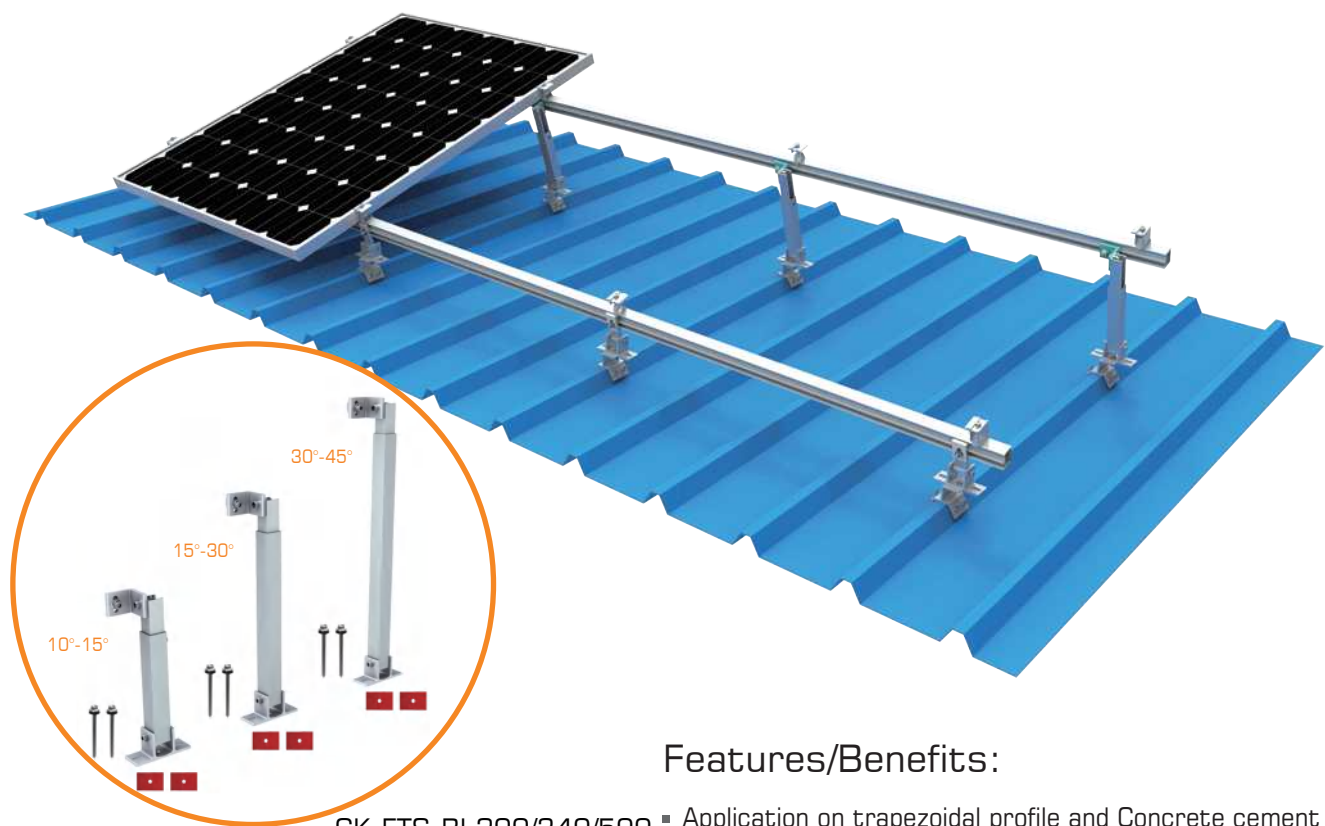

Features/Benefits:

- CK-FTS-BL200/340/500
- Application on trapezoidal profile and Concrete cement roofs
 - Portrait or Landscape orientation
 - Made of high class material AL6005-T5
 - Different tilt options
 - Optimizing the tilt to increase power generations









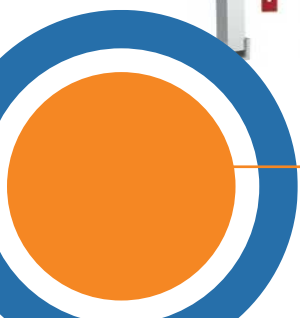
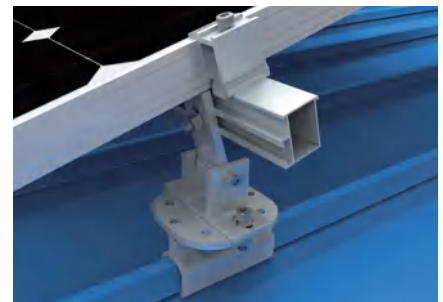
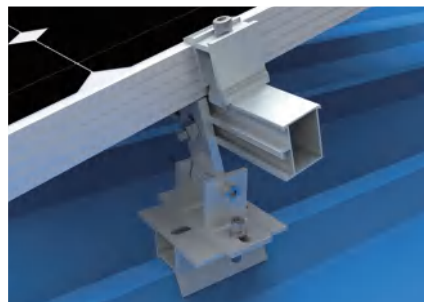



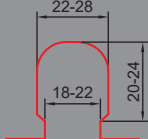

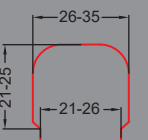

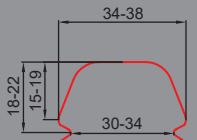
L footing

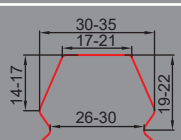
Combined with roof clamp

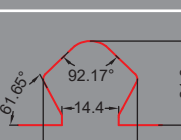
Free direction possible

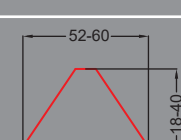

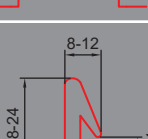
Standing Seam Clamps

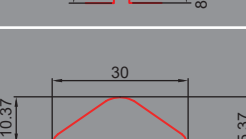
Type No.	Image	Profile reference	Material
CK-FTS-371			AL 6005-T5
CK-FTS-370			AL 6005-T5
CK-FTS-351			AL 6005-T5
CK-FTS-336			AL 6005-T5
CK-FTS-365			AL 6005-T5
CK-FTS-331			AL 6005-T5
CK-FTS-349			AL 6005-T5
CK-FTS-355			AL 6005-T5

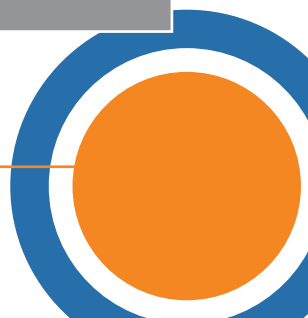

Ballast I-2 Mount

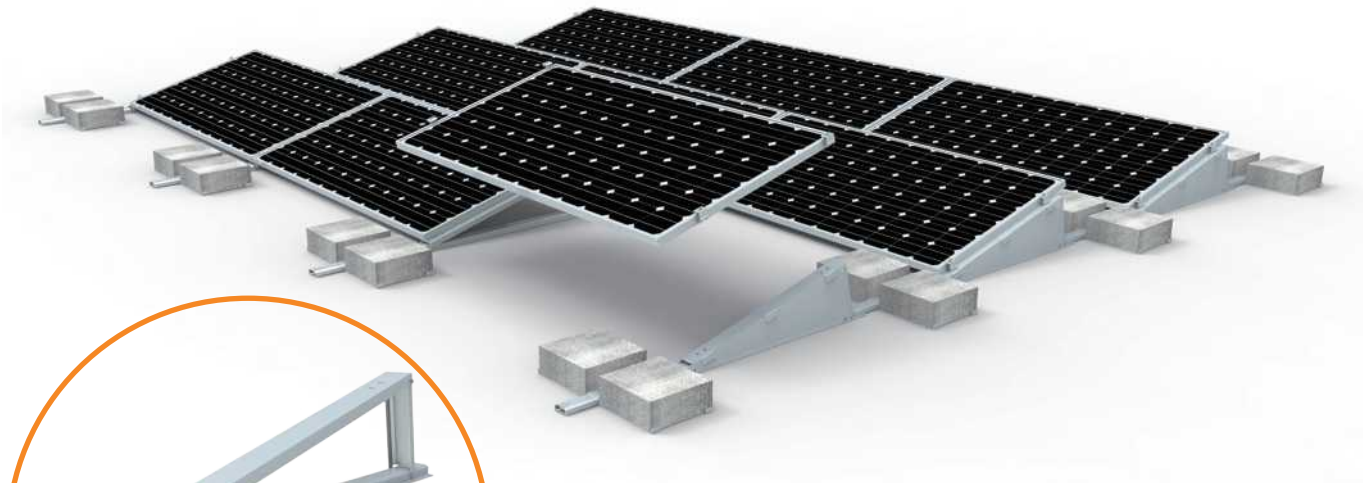

CK-BT21



Features/Benefits:

- Most universal for commercial flat roofs
- 1 panel Landscape orientation & East to West
- 10°, 15°, 20°, 25°, 30° tilted angle available
- Various modules configurations are possible
- Made of AL 6005-T5
- Highly class anodizing on surface treatment
- Pre-assembly and foldable
- Non-penetration to roof and light weight roof loading

East to West Configurations:

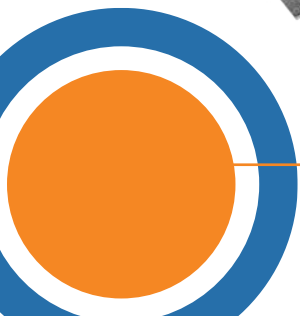
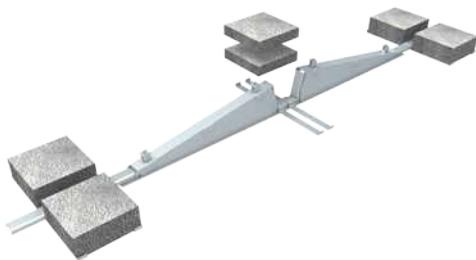

Ballast I-3 Mount

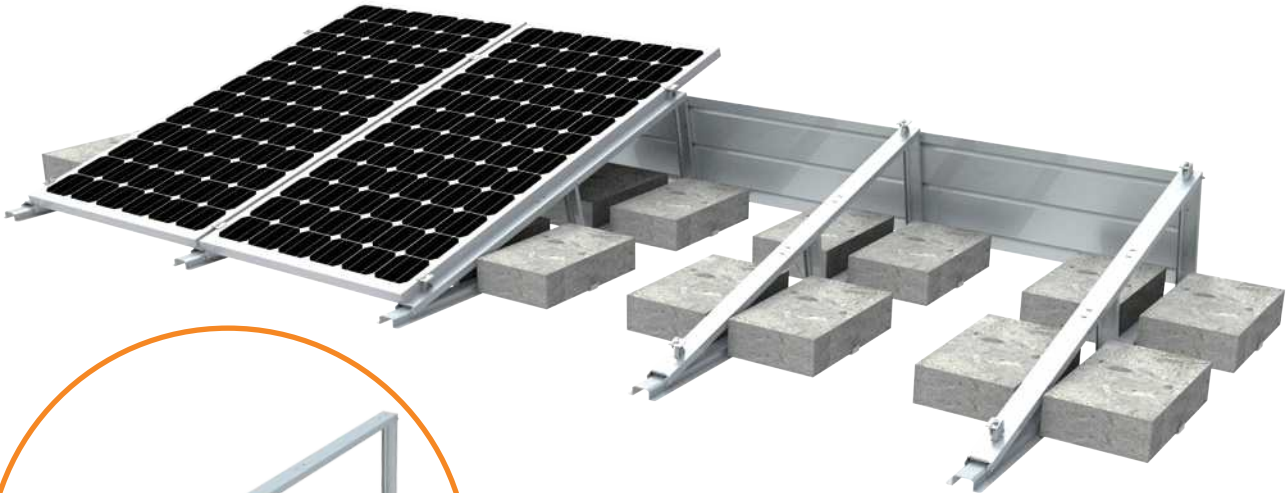

CK-BT31



Features/Benefits:

- Most universal for commercial flat roofs
- 1 panel Portrait & 2 panels Landscape orientation
- 10°, 15°, 20°, 25°, 30° tilted angle available
- Various modules configurations are possible
- Made of AL 6005-T5
- Highly class anodizing on surface treatment
- Pre-assembly and foldable
- Non-penetration to roof and light weight roof loading

Customized Configurations

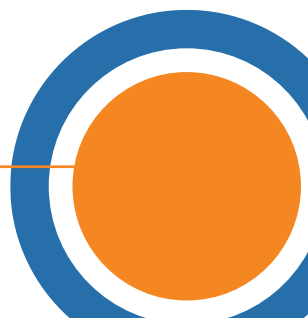

Ballast III Mount



CK-BL-3

Features/Benefits:

- Most cost-effective for commercial flat roofs
- 1 panel Landscape orientation
- 10°, 15°, 20°, 25°, 30° tilted angle available
- Various modules configurations are possible
- Made of Aluminum
- 1 step installation
- Non-penetration to roof and light weight roof loading



Simple Installations

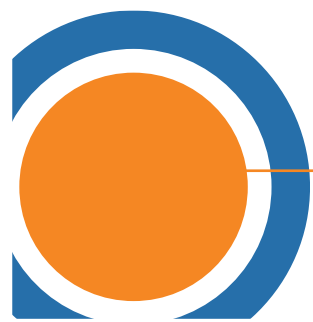

Ballast VI Mount

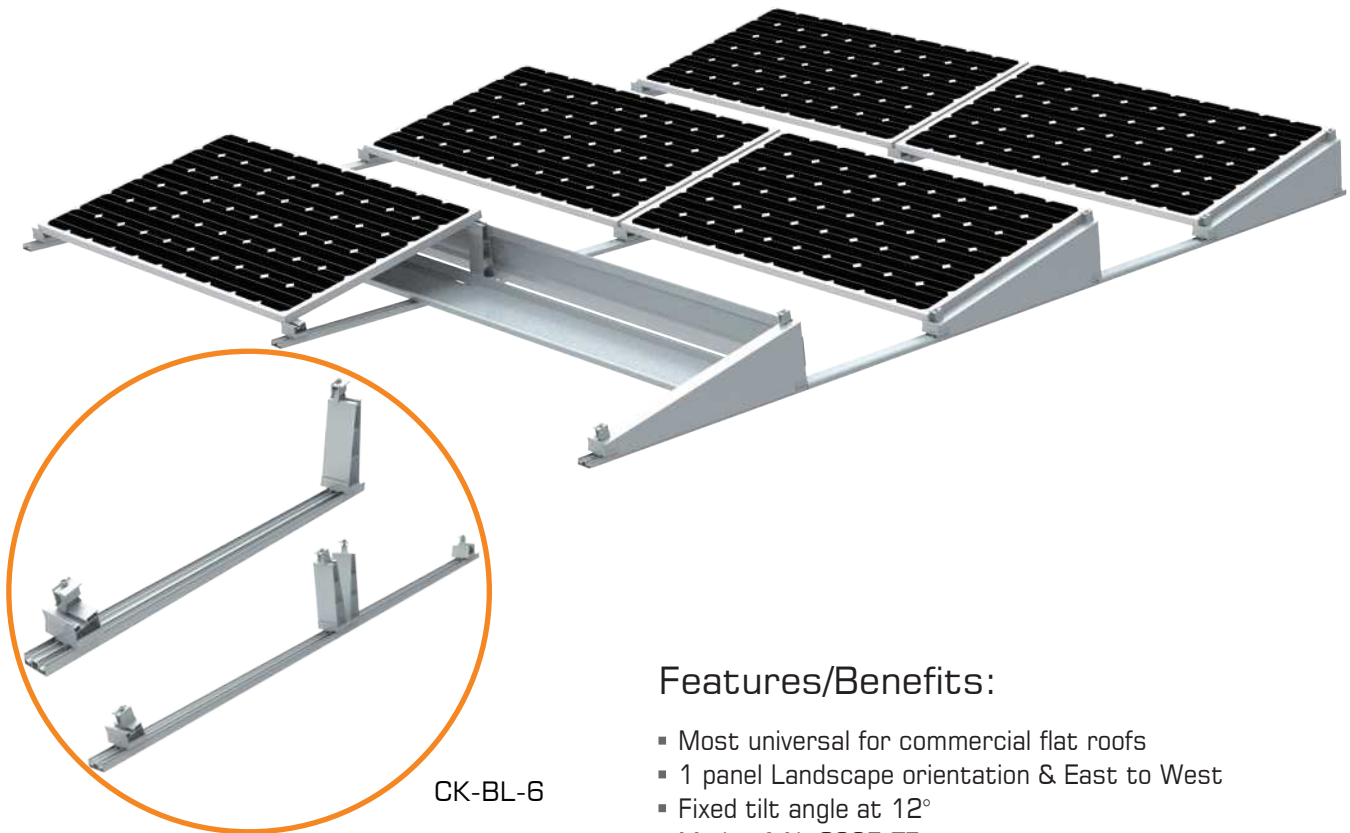

Features/Benefits:

- Most universal for commercial flat roofs
- 1 panel Landscape orientation & East to West
- Fixed tilt angle at 12°
- Made of AL 6005-T5
- Highly class anodizing on surface treatment
- Only 1 tools installation needed for all fixing
- Pre-assembly
- Non-penetration to roof and light weight roof loading



Ballast Placement Options

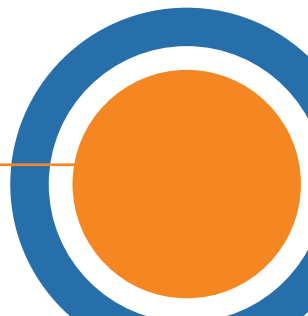
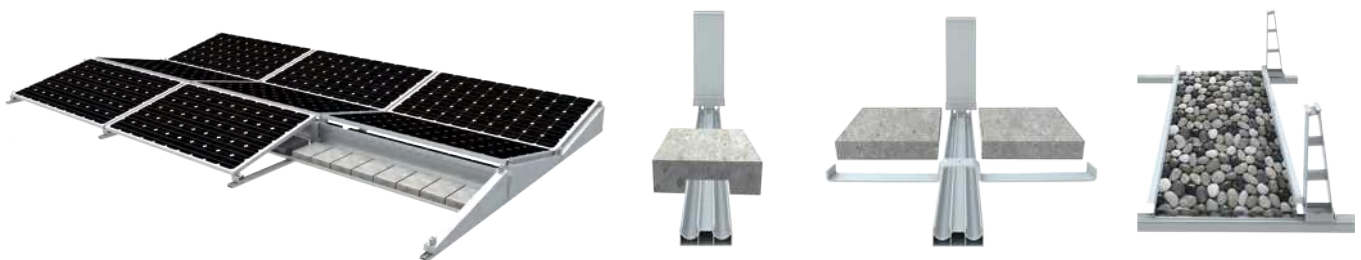

Adjustable Aluminum Triangular Mount

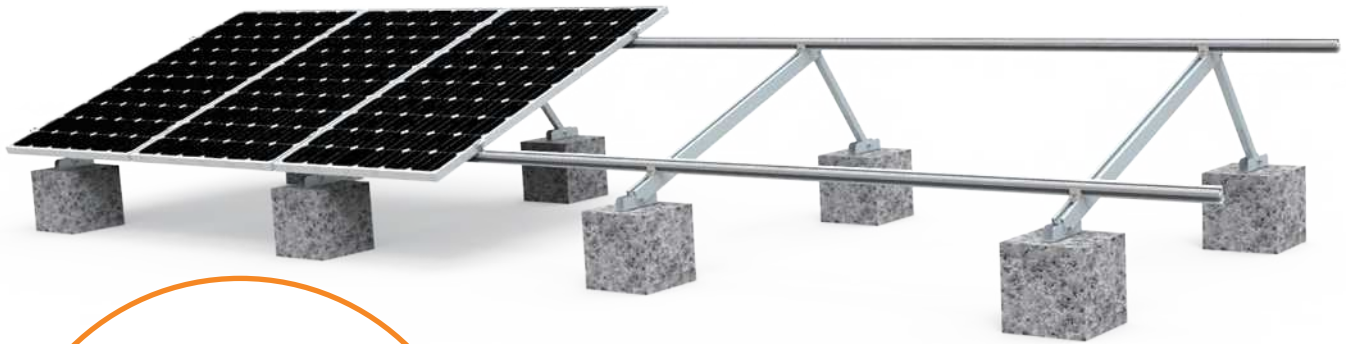

CK-ATT-BL

Features/Benefits:

- Most cost-effective for commercial flat roofs
- 1 panel Portrait orientation
- 10°-30° tilted angle adjustable
- Made of AL 6005-T5
- Highly class anodizing on surface treatment
- Pre-assembly and foldable
- Non-penetration to roof and light weight roof loading



Angel Adjustable by moving the concrete distance

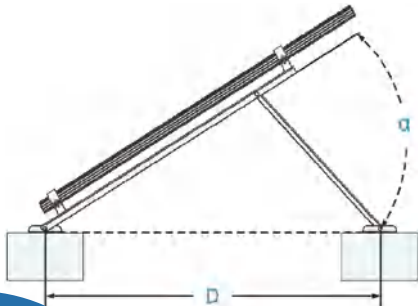

Degree	Concrete Distance(D/mm)
15°	1216
20°	1547
25°	1716
30°	1832

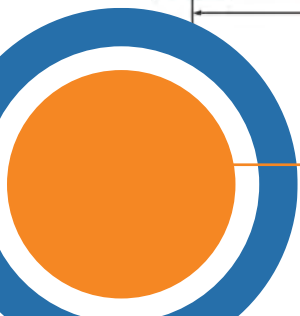

Fixed Aluminum Triangular Mount

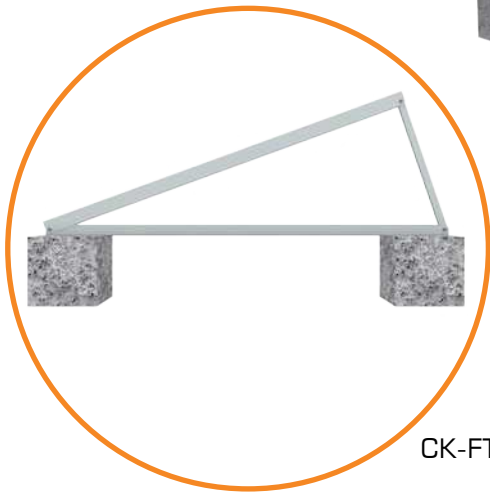
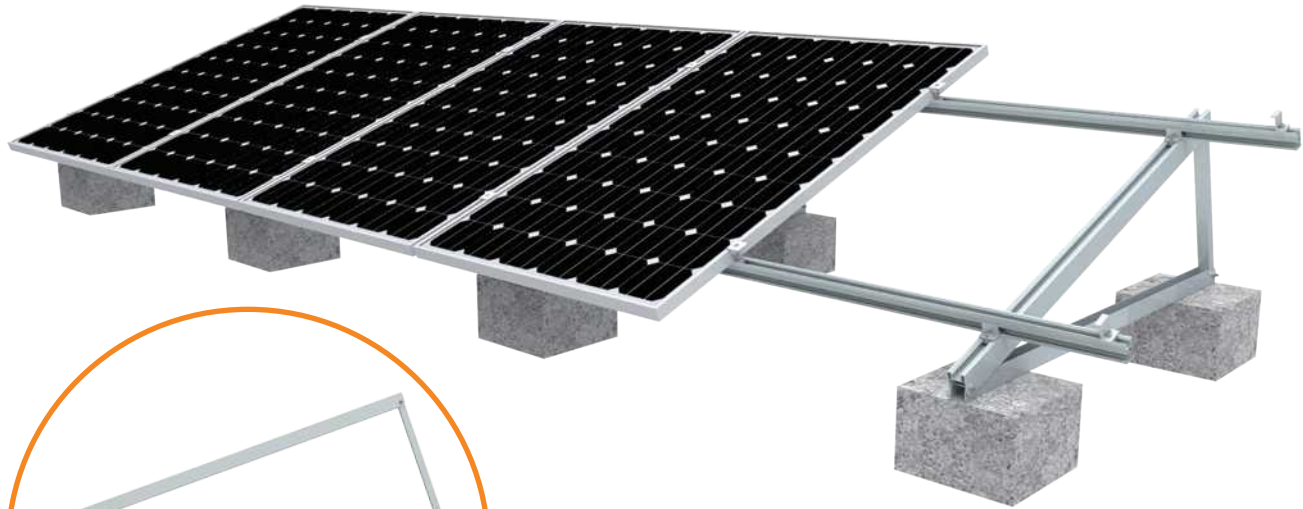

CK-FTT-BL

Features/Benefits:

- Most universal for commercial flat roofs
- 1 panel Portrait orientation
- 10°, 15°, 20°, 25° tilted angle available
- Made of AL 6005-T5
- Highly class anodizing on surface treatment
- Pre-assembly and foldable
- Non-penetration to roof with Lower cost



Tilt Mount On Metal Sheet

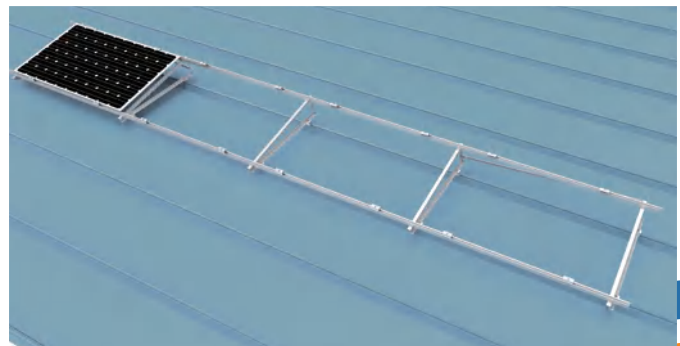

Classic Rail #7

Rail & Splice Kit



 <p>#7 Rail 4200,3200,2100mm</p>	 <p>Rail Splice Kit Spec:200mm</p>
 <p>Black #7 Rail 4200,3200,2100mm</p>	 <p>Black Rail Splice Kit Spec:200mm</p>





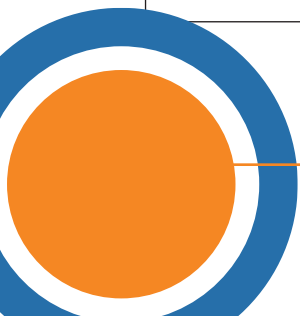





Mid Clamp & End Clamp

 <p>Mid clamp: 30/33/35/38/40/45/50mm</p>	 <p>End clamp: 30/33/35/38/40/45/50mm</p>
 <p>Black mid clamp: 30/33/35/38/40/45/50mm</p>	 <p>Black end clamp: 30/33/35/38/40/45/50mm</p>
 <p>Adjustable mid clamp: 30/35/40/45/50mm</p>	 <p>Adjustable end clamp: 35/40/45/50mm</p>
 <p>Thin Film Mid Clamp 5.6-7.3mm</p>	 <p>Thin Film End Clamp 5.6-7.3mm</p>



Infit Rail

Rail & Splice Kit

 <p>#516 Rail 4200mm,3200mm,2100mm</p>	  <p>#516 Rail Splice Kit Spec:150mm</p>
 <p>#517 Rail 4200mm,3200mm,2100mm</p>	  <p>#517 Rail Splice Kit Spec:150mm</p>
 <p>#518 Rail 4200mm,3200mm,2100mm</p>	  <p>#518 Rail Splice Kit Spec:150mm</p>
 <p>#519 Rail 4200mm,3200mm,2100mm</p>	  <p>#519 Rail Splice Kit Spec:150mm</p>

Mid Clamp & End Clamp

 <p>Mid clamp 30/33/35/38/40/45/50mm</p>	 <p>End Clamp 30/33/35/38/40/45/50mm</p>
 <p>Adjustable Mid Clamp 33-45mm</p>	 <p>Adjustable End Clamp 30-45mm</p>
 <p>Thin Film Mid Clamp 5.6-7.3mm</p>	 <p>Thin Film End Clamp 5.6-7.3mm</p>

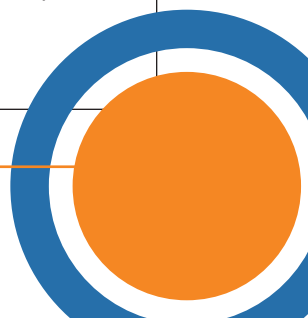

Single Pole Carport

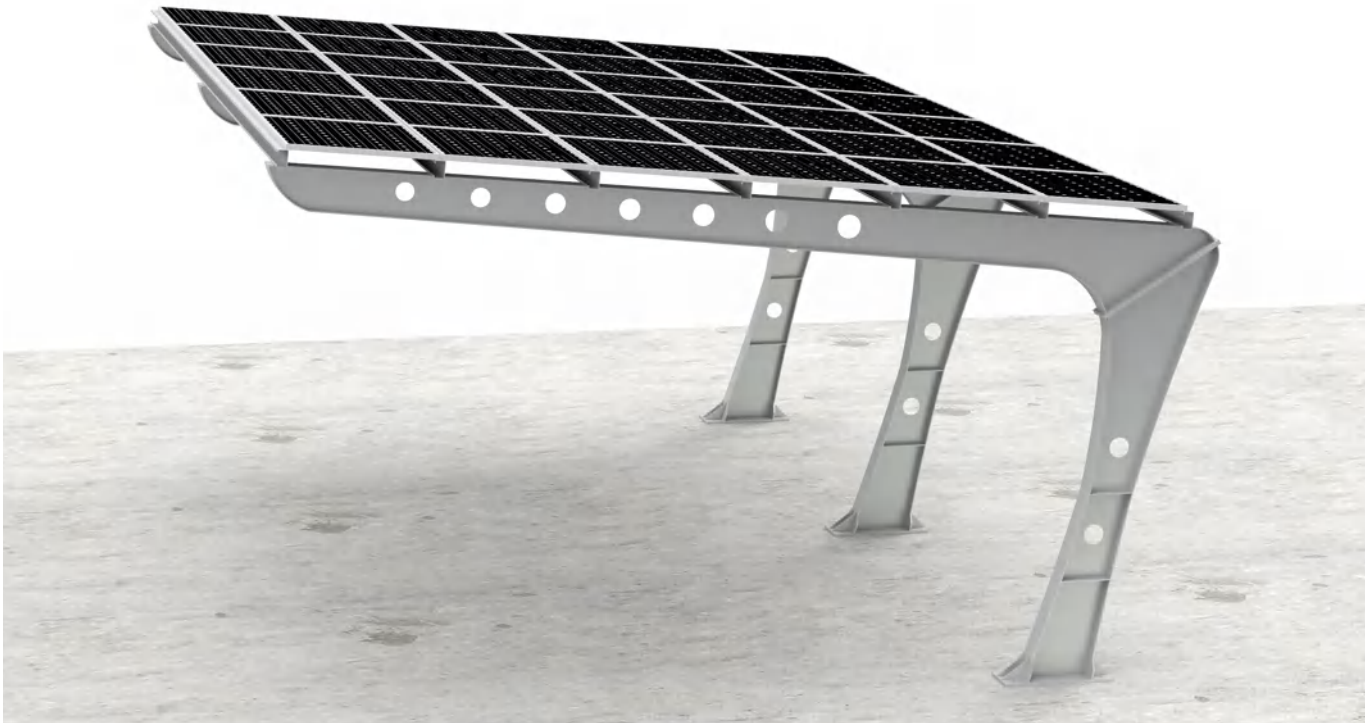

Features/Benefits:

- Mostly used for commercial parking lots
- Single pole, No obstacles between cars
- Portrait or Landscape orientation
- Made of Q355B, Hot Dip galvanizing or painting
- Double sides parking is available
- Water-proof option is provided
- Customized arrays and height are possible
- Strong calculation supported

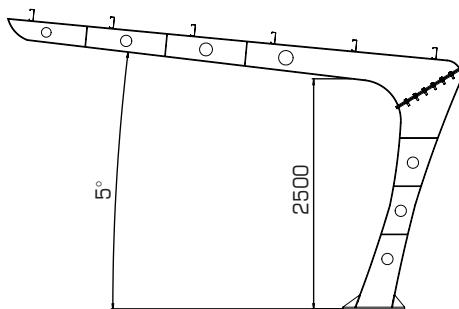

1 Side Parking

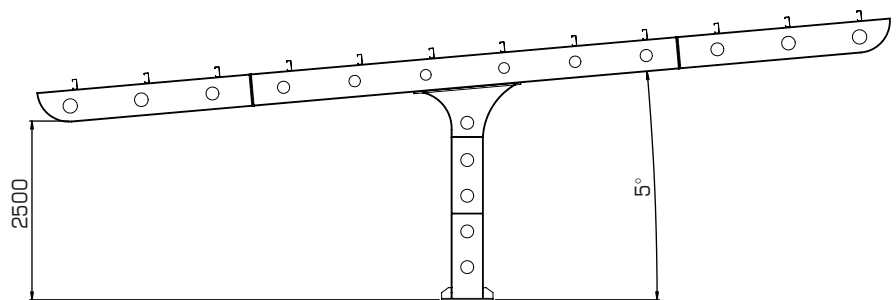

2 Sides Parking

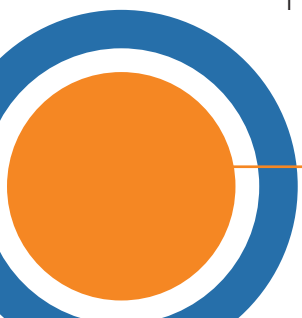

Ground screw type I with flange I

- Material steel Q235B
- High class hot galvanized 80 μ

Item No.	Diameter (mm)	Length(mm)	Thickness(mm)
CK-GS-F1-1200-3.0T	76	1200	3.0
CK-GS-F1-1600-3.0T	76	1600	3.0
CK-GS-F1-2000-3.0T	76	2000	3.0
CK-GS-F1-2500-3.0T	76	2500	3.0
CK-GS-F1-1200-3.5T	76	1200	3.5
CK-GS-F1-1600-3.5T	76	1600	3.5
CK-GS-F1-2000-3.5T	76	2000	3.5
CK-GS-F1-2500-3.5T	76	2500	3.5

Ground screw type I with flange II

- Material steel Q235B
- High class hot galvanized 80 μ

Item No.	Diameter (mm)	Length(mm)	Thickness(mm)
CK-GS-F2-1200-3.0T	76	1200	3.0
CK-GS-F2-1600-3.0T	76	1600	3.0
CK-GS-F2-2000-3.0T	76	2000	3.0
CK-GS-F2-2500-3.0T	76	2500	3.0
CK-GS-F2-1200-3.5T	76	1200	3.5
CK-GS-F2-1600-3.5T	76	1600	3.5
CK-GS-F2-2000-3.0T	76	2000	3.5
CK-GS-F2-2500-3.0T	76	2500	3.5

Ground screw type II with flange I

- Material steel Q235B
- High class hot galvanized 80 μ

Item No.	Diameter(mm)	Length(mm)	Thickness(mm)
CK-GSY-76F1-24-1200-3.0T	76	1200	3.0
CK-GSY-76F1-24-1600-3.0T	76	1600	3.0
CK-GSY-76F1-24-2000-3.0T	76	2000	3.0
CK-GSY-76F1-24-2500-3.0T	76	2500	3.0
CK-GSY-76F1-24-1200-3.5T	76	1200	3.5
CK-GSY-76F1-24-1600-3.5T	76	1600	3.5
CK-GSY-76F1-24-2000-3.5T	76	2000	3.5
CK-GSY-76F1-24-2500-3.5T	76	2500	3.5

Ground screw type II with flange II

- Material steel Q235B
- High class hot galvanized 80 μ

Item No.	Diameter(mm)	Length(mm)	Thickness(mm)
CK-GSY-76F2-24-1200-3.0T	76	1200	3.0
CK-GSY-76F2-24-1600-3.0T	76	1600	3.0
CK-GSY-76F2-24-2000-3.0T	76	2000	3.0
CK-GSY-76F2-24-2500-3.0T	76	2500	3.0
CK-GSY-76F2-24-1200-3.5T	76	1200	3.5
CK-GSY-76F2-24-1600-3.5T	76	1600	3.5
CK-GSY-76F2-24-2000-3.5T	76	2000	3.5
CK-GSY-76F2-24-2500-3.5T	76	2500	3.5

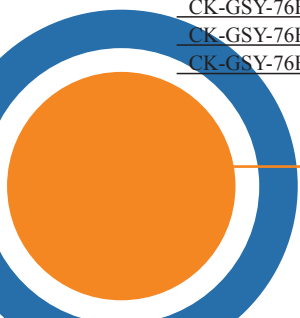

Cable Clip



CK-FSC-CP1/2/3

- CK-FSC-CP1** Solar cable clips 2.5 Hold one or two 2.5mm² solar cable
- CK-FSC-CP2** Solar cable clips 4.0 Hold one or two 4.0mm² solar cable
- CK-FSC-CP3** Solar cable clips 6.0 Hold one or two 6.0mm² solar cable

- Package 8000 PCS/CTN
- Weight 17.6 kg
- Made from stainless steel SUS304



CK-FSC-CP4/5

- CK-FSC-CP4** Solar cable clips 90°/180° 4.0 Hold one or two 4.0mm² solar cable
- CK-FSC-CP5** Solar cable clips 90°/180° 6.0 Hold one or two 6.0mm² solar cable

- Package 8000 PCS/CTN
- Weight 17.6 kg
- Made from stainless steel SUS304



CK-FSC-CP6

- CK-FSC-CP6** Solar cable clips to hold 3-4 cables, 3cables/6mm²; 4cables/4mm²

- Package 8000 PCS/CTN
- Weight 17.6 kg
- Made from stainless steel SUS304



CK-FSC-CP7/8

- CK-FSC-CP7** Solar cable clips 4.0 Hold four 4.0mm² solar cable for thin-film module
- CK-FSC-CP8** Solar cable clips 6.0 Hold four 6.0mm² solar cable for thin-film module

- Package 2400 PCS/CTN
- Weight 5.3 kg
- Made from stainless aluminum 6005-T5

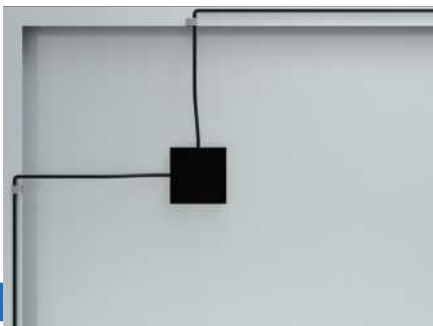

CK-FSC-CP1/2/3/4/5



CK-FSC-CP6



CK-FSC-CP7



Project Size: 2KW Installation Site: USA



Project Size: 10KW Installation Site: China



Project Size: 5KW Installation Site: USA



Project Size: 10MW Installation Site: India



Project Size: 50MW Installation Site: China



Project Size: 1.3MW Installation Site: Nicaragua



Project Size: 400KW Installation Site: Japan



Project Size: 300KW Installation Site: Japan



Project Size: 12KW Installation Site: Netherlands



Project Size: 60KW Installation Site: Lebanon



Project Size: 500KW Installation Site: China



Project Size: 78KW Installation Site: South Africa

