

User Manual

Contents

1. Precautions	02	7. Zlink	21
2. Product Overview	03	7.1 Wireless / wired connection steps	23
2.1 Product Front	03	8. GPS Navigation	25
2.2 Product Back	04	9. File Manager	26
2.3 Accessory	05	10. XCDVR2 Installation	27
2.4 Interface Definition Diagram	06	11. LCD Screen Usage	28
2.5 Plane Wiring Diagram	07	12. GPS Antenna Installation	29
3. Basic Settings	09	13. Settings	31
3.1 Pictures of different original vehicle systems	09	13.1 About-Factory Setting	32
3.2 Car Type: Resolution Setting	10	13.2 Factory Setting	33
3.3 Car aux switch mode	11	13.2.1 Front door & Rear door	33
3.4 Original AUX shortcut key setting	12	13.2.2 Boot Start Logo	34
3.5 Volume	13	13.3 System Setting	35
3.6 Navigation	13	13.3.1 Network & Internet	36
3.7 BackCar	14	13.3.2 Apps & Notifications	36
4. Bluetooth	15	13.3.3 System	37
4.1 Bluetooth Connection Steps	15	16. 4G Mirco SIM Card	38
5. Music	19	17. Specifications	39
6. Video	20	18. FAQ	40

Precautions

- Installation or servicing of this product by persons without training and experience in electronic equipment and automotive accessories may be dangerous and could expose you to the risk of electric shock, injury or other hazards.
- Do not allow this product to come into contact with liquids. Electrical shock could result. Also, damage to the product, smoke, and overheating could result from contact with liquids.
- If liquid or foreign matter should get inside this product, park your vehicle in a safe place, turn the ignition switch of(ACC OFF) immediately and consult your dealer or the customer service. Do not use this product in this condition because doing so may result in a fire, electric shock, or other failure.
- If you notice smoke, a strange noise or odor from this product, or any other abnormal signs on the LCD screen, turn off the power immediately and consult your dealer or the customer service. Using this product in this condition may result in permanent damage to the system.
- Do not disassemble or modify this product, as there are high-voltage components inside which may cause an electric shock. Be sure to consult your dealer or the customer service for internal inspection, adjustments or repairs.
- Slots and openings in the cabinet are provided for ventilation to ensure reliable operation of the product, and to protect it from overheating. To prevent fire hazard, the openings should never be blocked or covered with items (such as papers, floor mat, cloths).
- The head unit is applicable to vehicles with 12V power system(negative grounded). Please do not install it directly on the vehicles with 24V for avoiding product failure.
- Please turn off the car and disconnect ACC from B + before installation for avoiding short circuit.
- Please insulate the power output wire for avoiding boot failure caused by short circuit.
- Please do not use the car audio for long time after turning off the engine, or it will exhaust the battery power.
- Never set the volume of this product so high that you cannot hear outside traffic and emergency vehicles.
- Keep this manual handy as a reference for operating procedures and safety information.

Product Front



- 1. Home
- 2. Touch to close the screen

- 3. Display currently running apps
- 4. Return



- 5. Micro SIM card slot
- 6. Microphone hole
- 7. Reset hole

Product Back

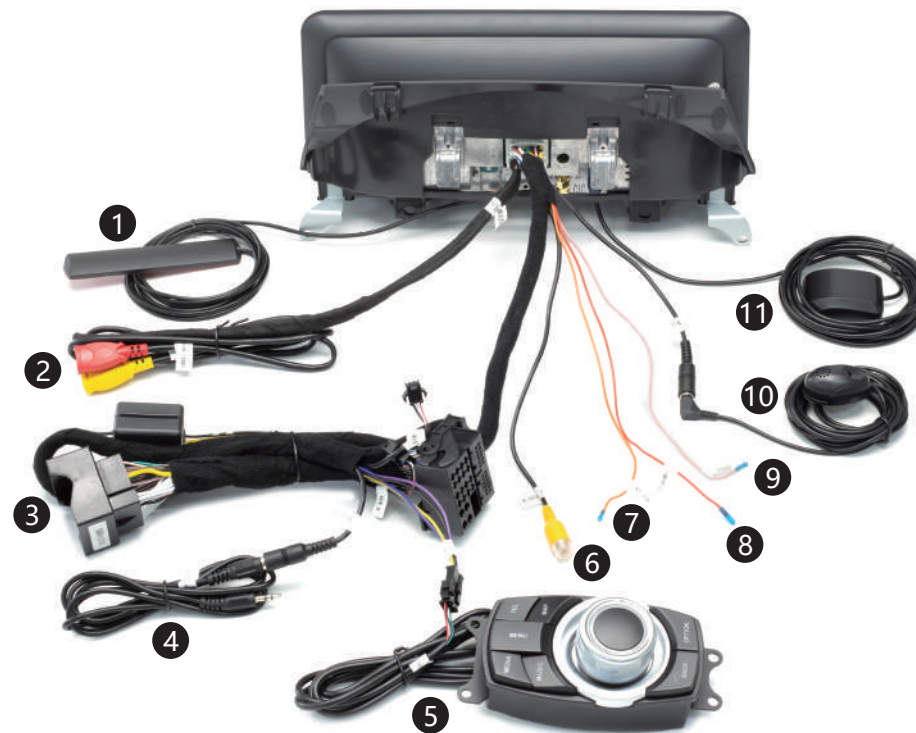

- 1. 4G/WIFI Antenna
- 2. USB Cable
- 3. ISO Port
- 4. Audio Cable (AUDIO OUT)
- 5. iDrive
- 6. Rear View Camera Input (CVBS/AHD)
- 7. Reserved ACC Line (ACC-IN)
- 8. Camera Power Supply (CAMERA+12)
- 9. Reversing Detection Line (BACK)
- 10. External Microphone (MIC)
- 11. GPS Antenna

Accessories



Power Line*1



GPS Antenna *1



Audio Input Harness*1



iDrive(optional)*1



External Microphone*1



USB Adapter Cable*1



4G/Wi-Fi Antenna*1



Operating Instruction*1

Interface Definition Diagram

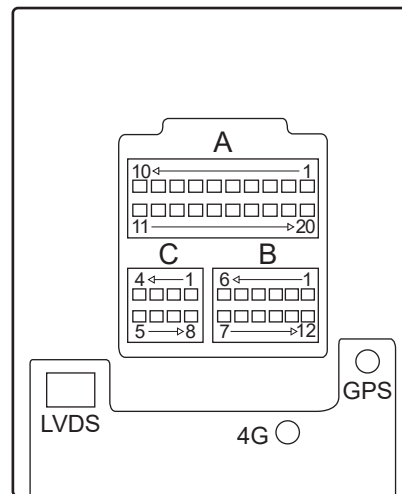

A	1	B+	20	ACC	B	1	NC	12	NC
	2	GND	19	CCD12V		2	MIC+	11	MIC-
	3	BACK	18	KEY1		3	NC	10	NC
	4	KEY2	17	CAN_H		4	NC	9	NC
	5	CAN_L	16	LED-5V		5	NC	8	NC
	6	CAM_IN	15	GND		6	NC	7	NC
	7	AUX_DET	14	FL_IN-		C	1	GND	8
8	RCA_L	13	FL_OUT-	2	USB_5V		7	USB_5V	
9	GND	12	FL_IN+	3	USB_OTG_DM		6	USB_HOST_DM	
10	RCA_R	11	FL_OUT+	4	USB_OTG_DP		5	USB_HOST_DP	

Plane Wiring Diagram

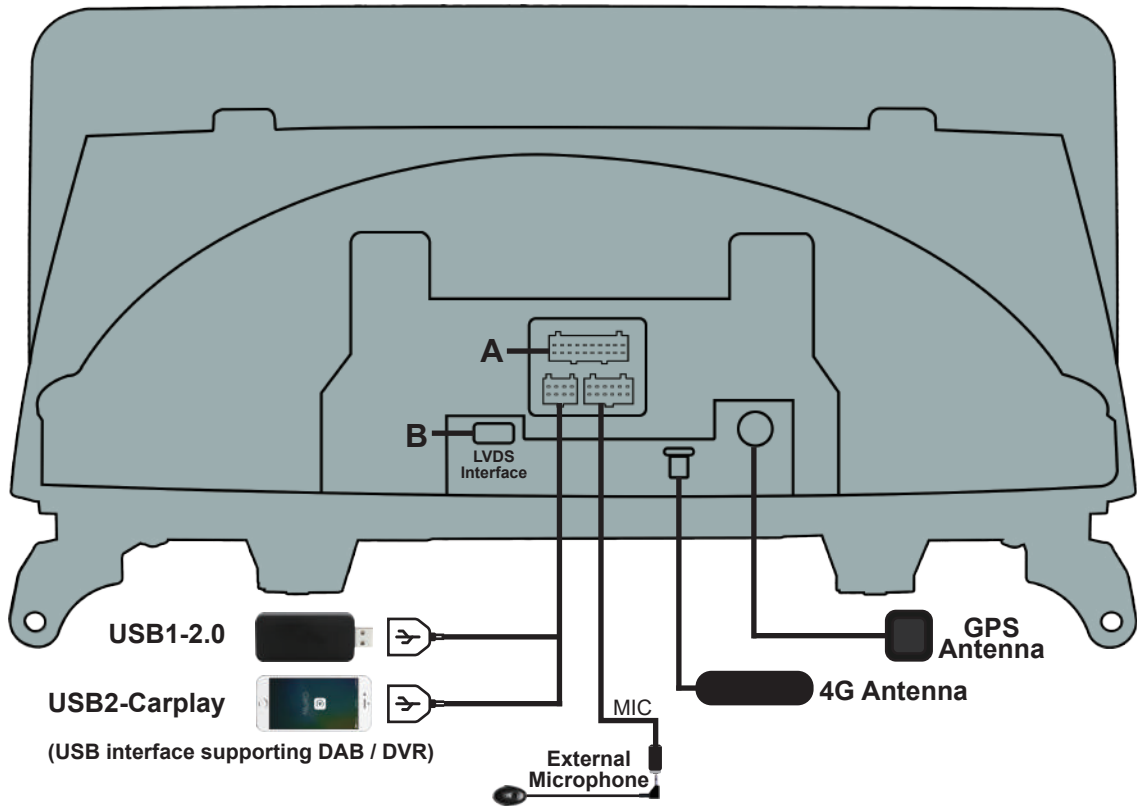

Plane Wiring Diagram

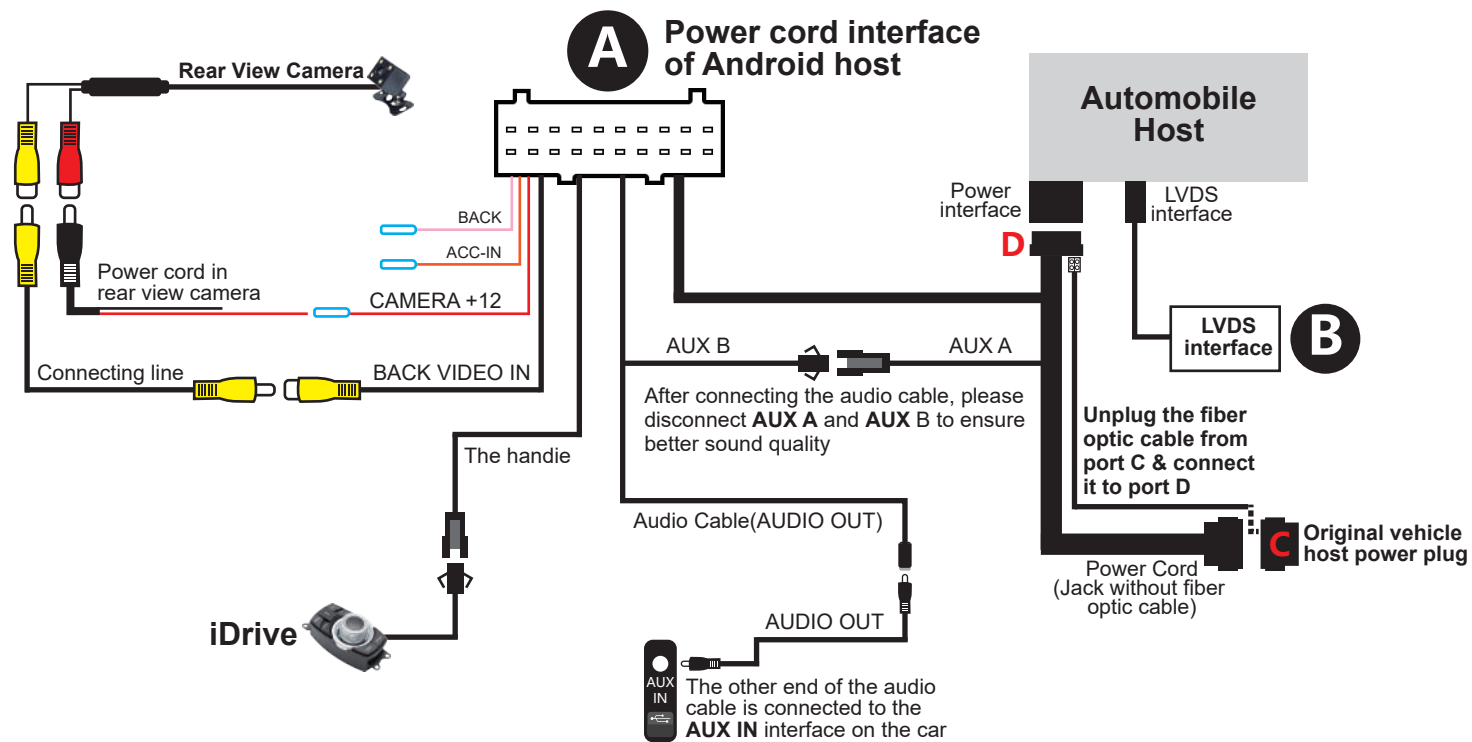

Basic Settings

*After installing multimedia navigation, to ensure normal use, please follow the steps below to set the basic settings in multimedia navigation.

Pictures of different original vehicle systems:

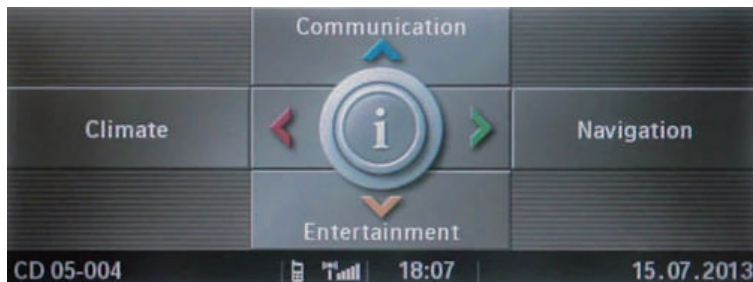

Picture 1



Picture 2



Picture 3

Picture 1: CCC System

Picture 2: CIC System

Picture 3: NBT System

Basic Settings

1. Car Type: CCC / CIC / NBT / original vehicle without system resolution option setting

Click Settings → About → Factory Settings (enter password 8888) → BMW Settings → Car Type → select the resolution corresponding to the original system.

Note: if the splash screen or the screen is not full after your setting is completed, because you have not selected the correct resolution, please continue to select the resolution corresponding to your machine.

The resolution of the original vehicle without display screen (without system) is "OFF".

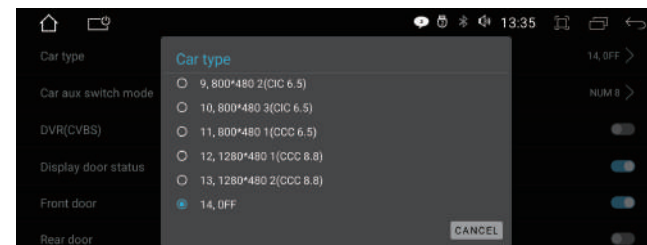
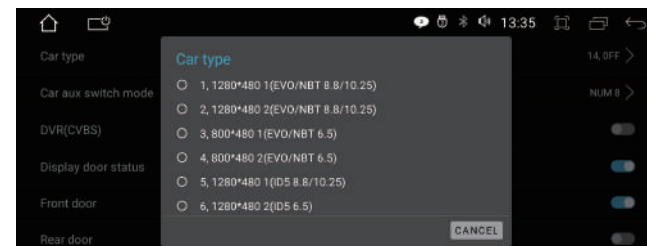

Basic Settings

2. Car aux switch mode

Click Settings → About → Factory Settings (enter password 8888) → BMW Settings → Car aux switch mode.

1. If your car has eight numeric keys, please select "NUM 8"
2. If your car has six numeric keys, please select "NUM 6"
3. If your car does not have numeric keys, please select "OFF"

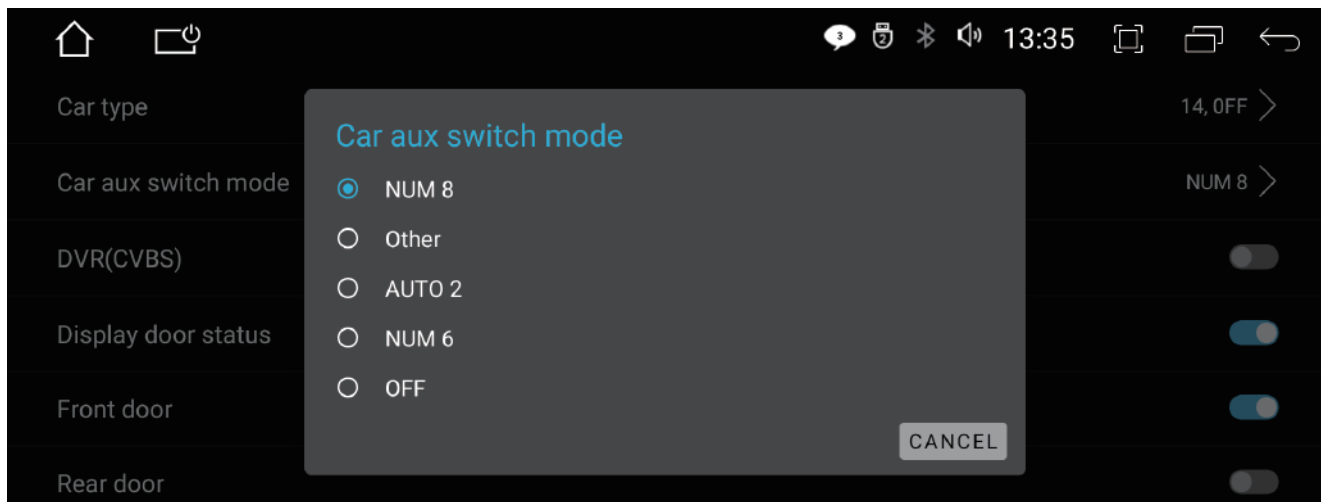

Basic Settings

3. Original AUX shortcut key setting

***To ensure that you can hear the audio on the Android navigation machine, please set the aux shortcut key according to the following steps:**

1. Click "My BMW" on the interface to enter the setting interface and click "CD/Multimedia".

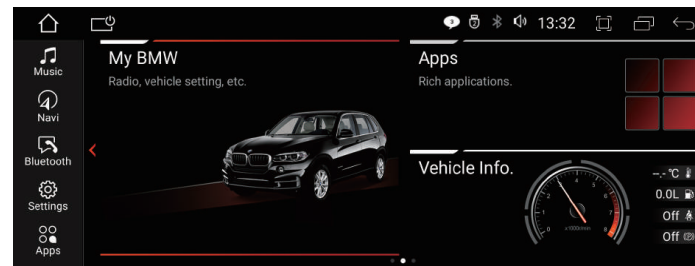

Picture 1

2. When you get to the interface in Figure 1, long press the number key "8" on the car (if the number key of the original car has only 6 keys, long press "6"). When the navigation machine emits a "beep" sound, it indicates that the setting is successful.

There is no display screen or number keys in the car. The methods are as follows:

1. Plug the audio cable into the aux interface on the car.
2. Manually switch to [Picture 1] aux status interface with the iDrive.

Basic Settings

4. Volume

Click Settings → Volume → volume option of corresponding system to adjust as needed.



5. Navigation

Click Settings → Navigation → Choose a map app → select which map app to use.

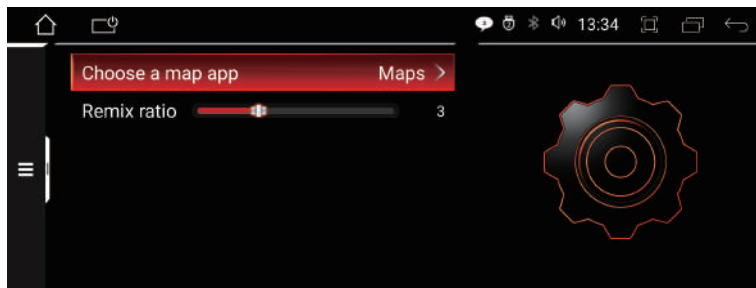

Basic Settings

6. BackCar

Click Setting → BackCar → setting to turn on or off the original vehicle mode and other functions.

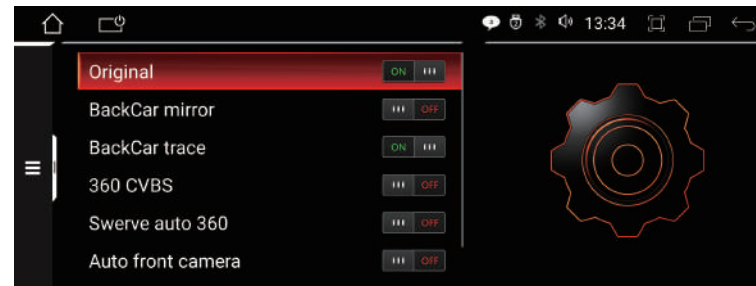

Original :

[**ON**] the original car has its own camera, Click "ON" to open it.

[**OFF**] There is no camera, Click "OFF" to close it.

BackCar mirror:

The left and right positions displayed on the machine will be opposite to the left and right positions you see. Click "ON" to turn on, and the display will be normal.

Bluetooth

Touch [] to enter the Bluetooth interface, as shown in the figure.

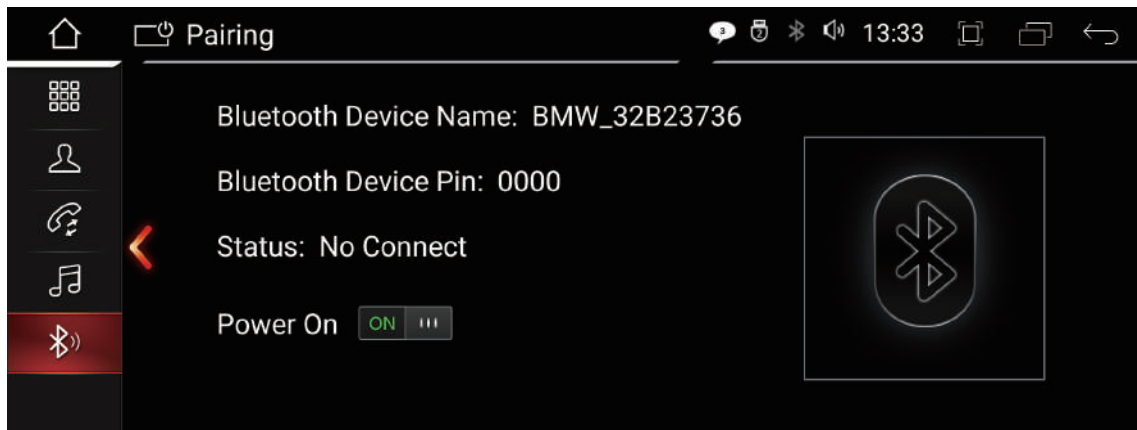

[] return to the main interface

[] exit Bluetooth

Connecting Bluetooth steps

1. Turn on the Bluetooth function of the mobile phone.
2. Select the Bluetooth device name "bmw_32b23736".
3. Enter the password: [0000].
4. After the connection is established, your phone name will be displayed in the "paired devices" list.

Bluetooth

Dial

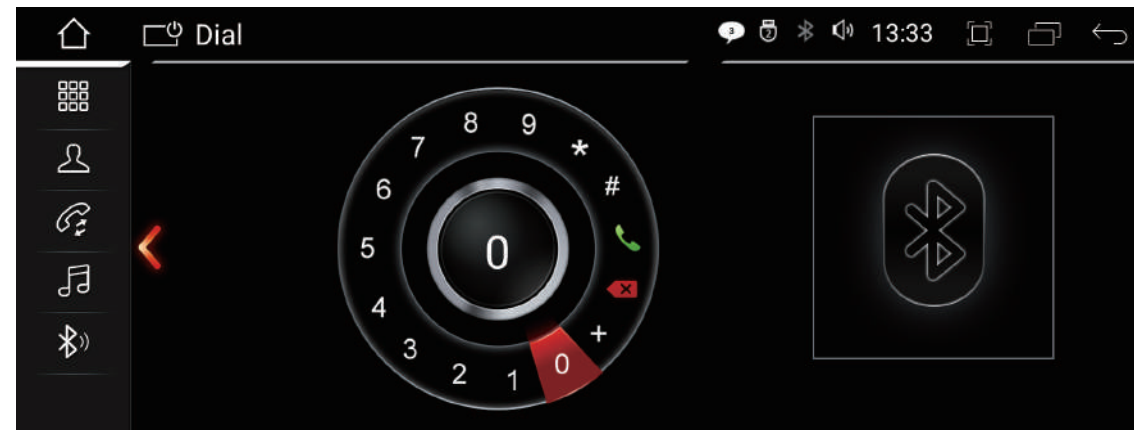

After the Bluetooth connection is established, the user can make a call directly or touch "  " on the dial to delete the entered wrong number.

After entering the phone number, press "  " to make a call, and press "  " to hang up.

Bluetooth

Contacts

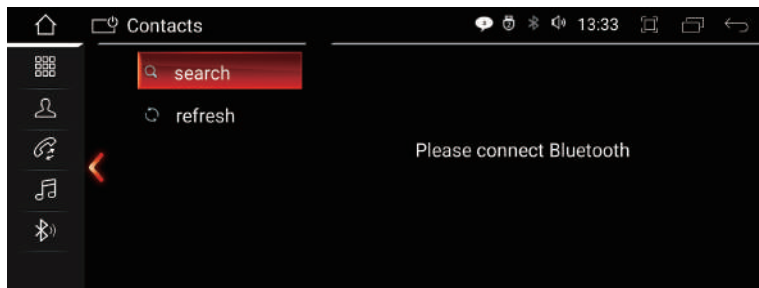



This machine supports the synchronization of contact information between mobile phone and this machine. When Bluetooth is connected, click allow contacts to sync on your phone.

[] search for the specified contact.

[] download again.

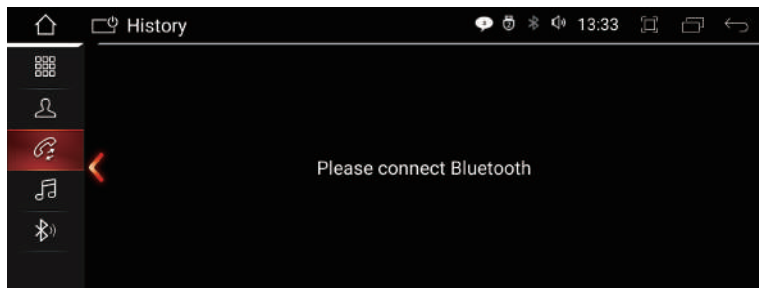
History





[] enter the call record interface, Display all Bluetooth call records.

Bluetooth

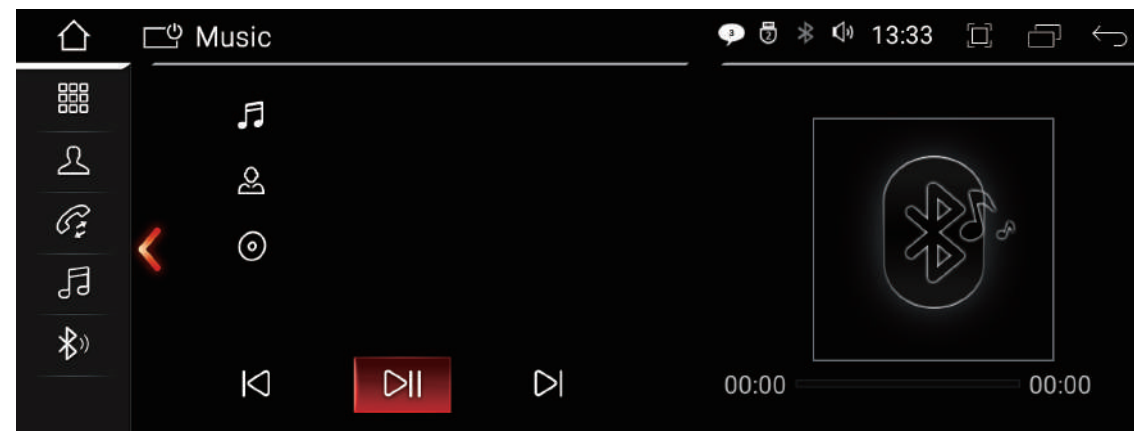
Bluetooth music



This machine supports Bluetooth music playback. Users can play music on the mobile phone and transmit it to the speaker of the machine through Bluetooth.

[] previous [] play / pause [] next

Note: all phone models may not be supported. If you have problems connecting Bluetooth, please contact us.

Music

You can copy audio files to SD card or USB flash drive, and then plug them into the car USB interface. Click to play music.

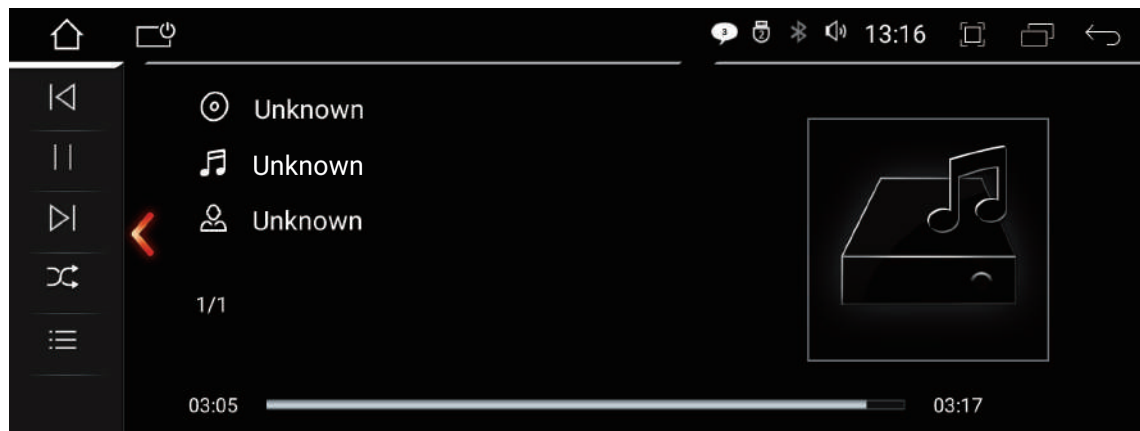

[<] previous [||] play / pause [>] next

[↺] repeat [↻] random play / sequential play [≡] song list

Video

Touch the video icon on the main interface. It supports internal flash storage and external SD card or USB drive.

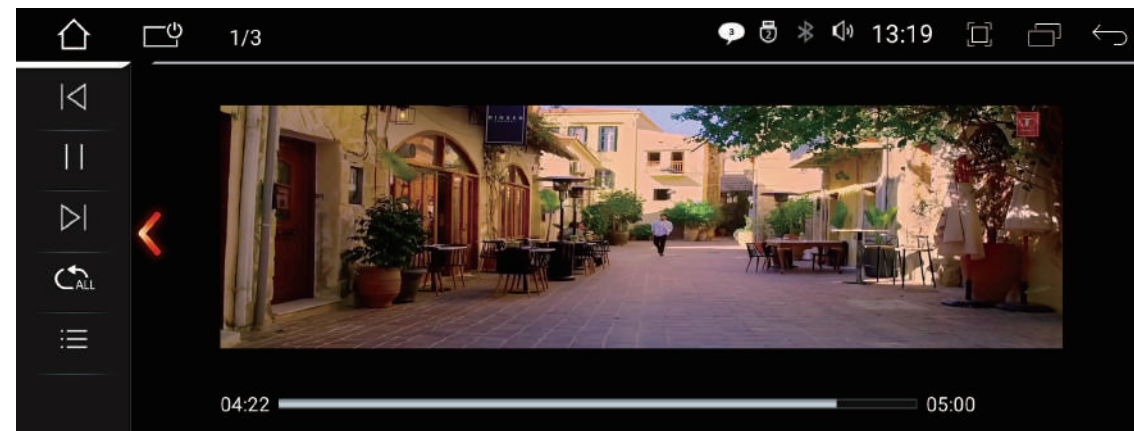

[<] previous [||] play / pause [>] next

[↺] repeat [↻] random play / sequential play [≡] song list

Zlink

Connect your iPhone to the car host, you can navigate, make calls, send and receive messages, listen to music, etc. (compatible with iPhone 5 and later versions).

Support wired and wireless connections. Android auto connection.

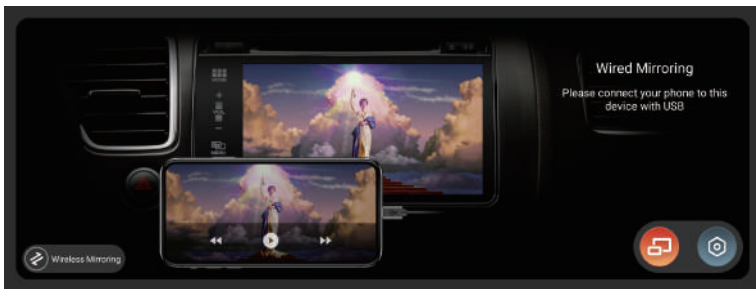

Picture 1



Zlink

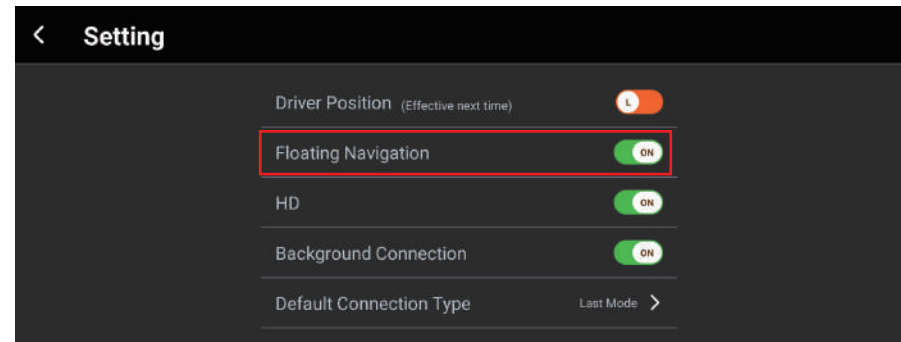

Picture 2

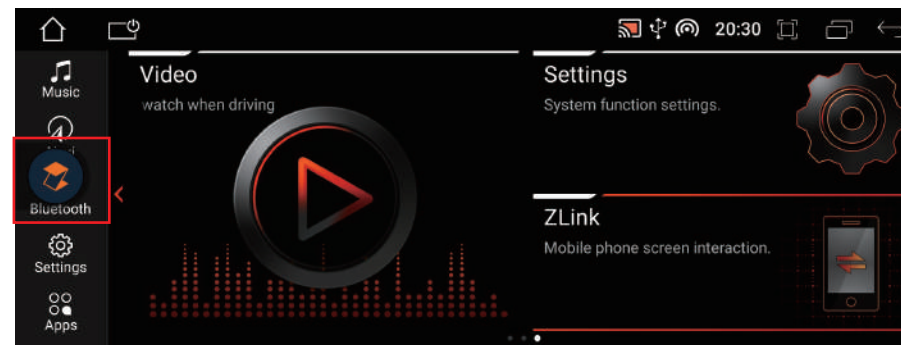

Picture 3

Click the small setting icon  on Picture 1 to enter Picture 2. You can set floating navigation, which is more convenient to enter the software.

Picture 3: floating navigation icon interface

Zlink

Wired connection steps

1. Enter zlink app and use iPhone USB cable to connect iPhone to Carplay USB port of car.
2. When the iPhone prompts "allow Carplay", click "allow" to use.

Wireless connection steps

1. Connect Bluetooth.
2. Enter zlink app.
3. When iPhone prompts "allow Carplay in locked state", please click "allow".
4. Click the wireless setting interface in the mobile phone and select the network name of the navigation machine to connect.

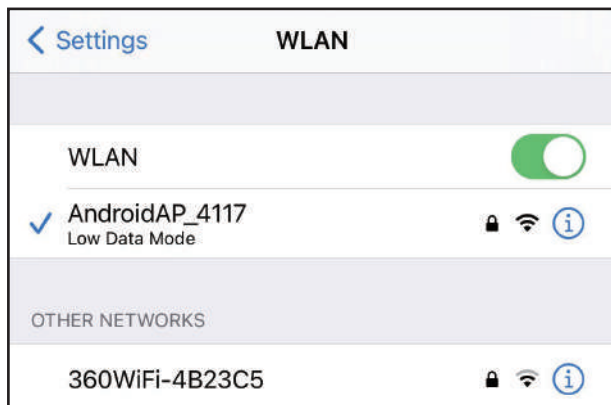

Note: when connecting zlink for the first time, turn on the wireless settings of the mobile phone and connect to the wireless on the machine. (the name is automatically displayed in my network.)
***Only when you connect zlink for the first time, you need to click the network name of the navigation machine on the mobile phone.**

Zlink

The interface of successful connection is as follows:

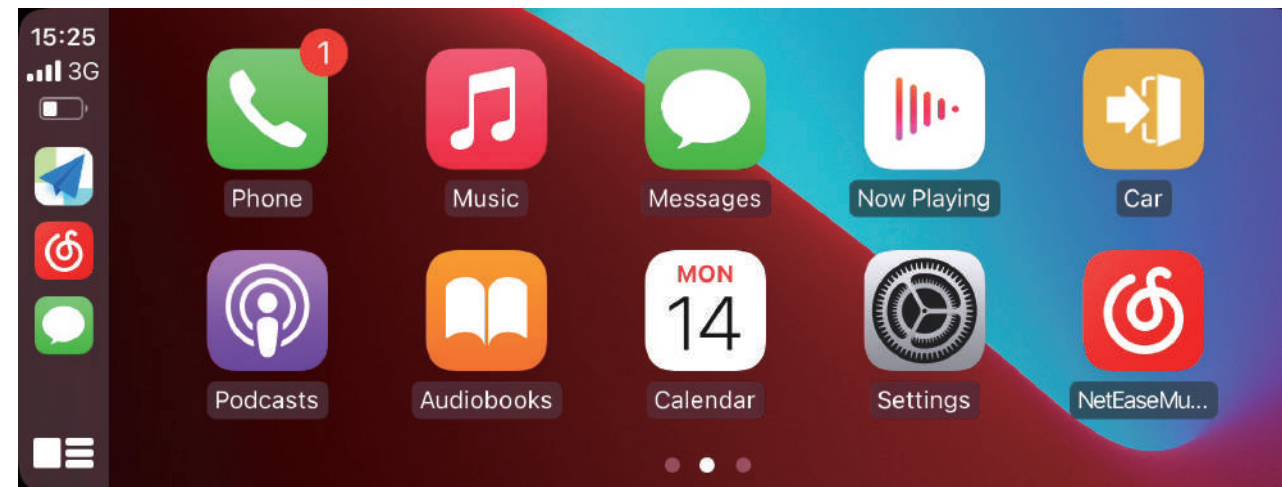

GPS Navigation

The system supports a variety of navigation software, "Click Settings → Navigation → Choose a map app", and select navigation software.

How to use GPS Navigation ?

1. Online map

Google Map app is preinstalled on car stereo. Once connected to the network, you can use the online map.

2. Offline map

If you are in an area that supports downloading the data of Google offline map, you can save the area map data to the car stereo in Google Map and use it offline. Or you download other offline map apps in the Google Play such as Here WeGo.

3. Buy a map card

Buy a map card applicable to Android car stereo, and insert the map card into the SD card slot of car stereo, then set the navigation path to run GPS.

4. Screen mirroring

For iPhone, the map on the phone can be synchronized to the car stereo screen via PhoneLink function.

For Android phones, the map on the phone can be synchronized to the car stereo screen via EasyConnection function.

Notes

- You can also enter Google Play to download other navigation apps like Waze, Sygic etc.
- Some navigation apps will specify the storage path of map data, which doesn't support storing map data to external Micro SD card or USB flash drive.

FileManager

You can view, copy, paste, and delete files in the memory/SD card/USB flash drive through the ES file explorer.

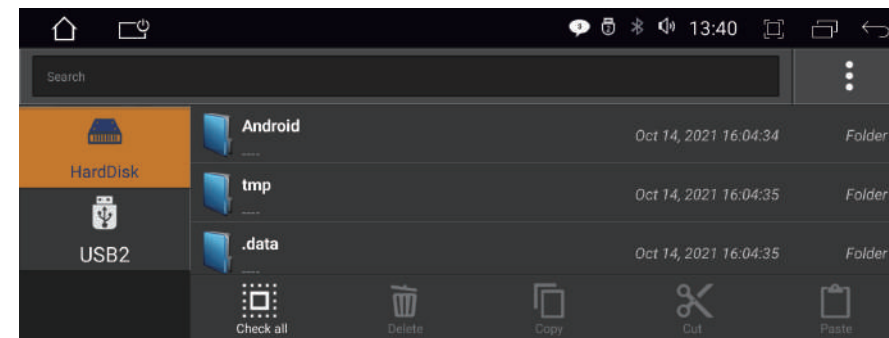
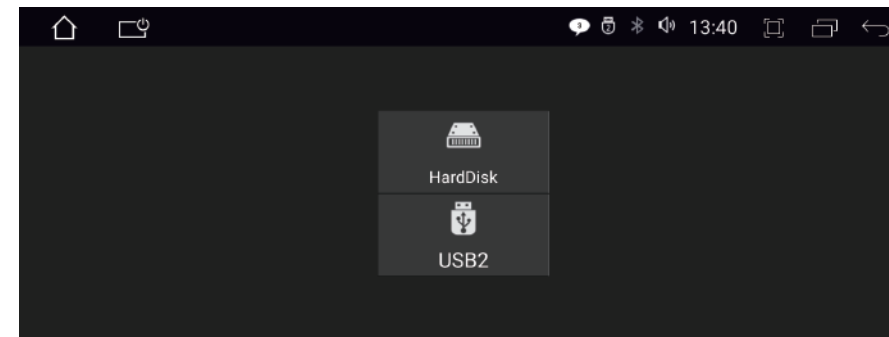

XCDVR2 installation

Installation steps:

1. Plug XCDVR2 into USB interface of navigation machine.
2. Click "file manager" → "USB2" → find the APK "ucardvr" of XCDVR → install.

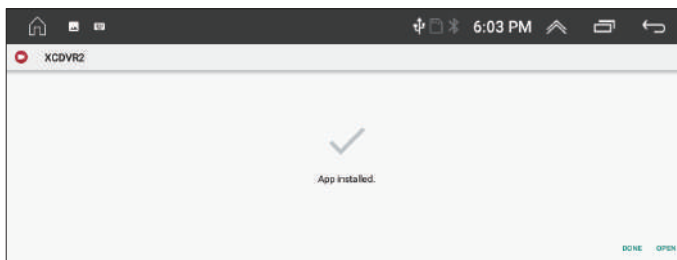
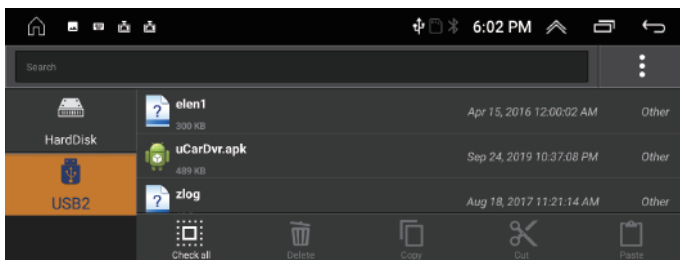
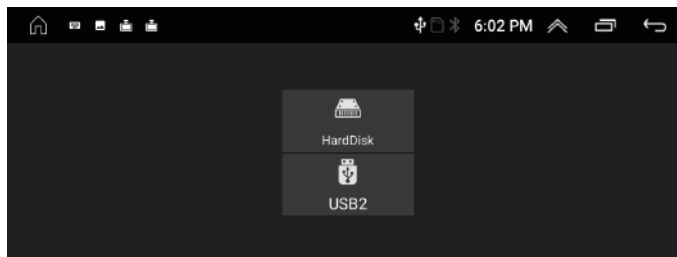
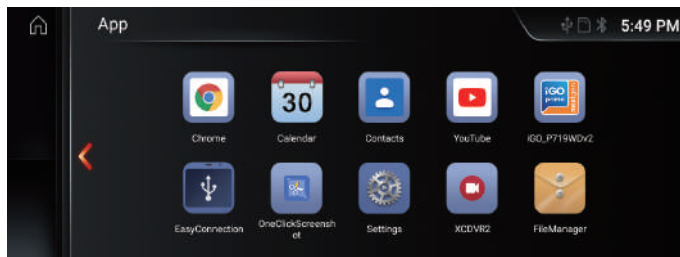

LCD Screen Usage

About LCD

- Small black dots or bright dots may appear on the LCD screen. This is not a defect but merely the specification of LCD.
- If in use in cold areas, the LCD screen may be dimmer after power on but the brightness will be adjusted to normal after a short while.
- If exposed directly under sunlight, user may be difficult to see the LCD screen due to reflection.

Maintaining the LCD screen

- Please off the power before cleaning the LCD screen. Wipe the screen with soft fabric to prevent scratch on the surface.
- Please do not use wet towel, benzene, and chemical related cleaners to clean the LCD screen.

Notes

- Do not expose the display screen directly under the sunlight or heat for a long period of time to prevent damage to the LCD screen.
- Do not expose the display screen directly under sunlight when it is not in use.
- The display screen should be used within the temperature ranges as per below:
 - a) Operating temperature range : $-10^{\circ}\text{C} \sim +50^{\circ}\text{C}$
 - b) Storage temperature range : $-20^{\circ}\text{C} \sim +80^{\circ}\text{C}$

Shall not interfere with the airbags and other safety features or devices in the vehicles.

GPS Antenna Installation

The GPS antenna can be mounted inside or outside the car, such as the dashboard or the roof.

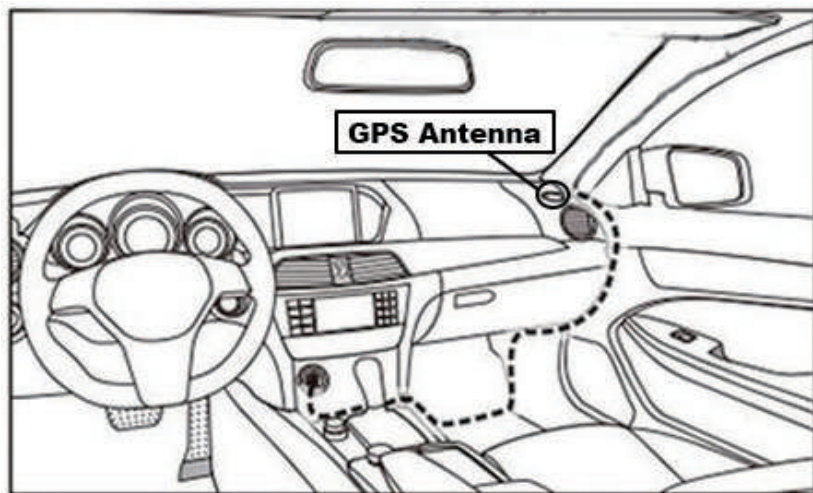

Note

the GPS antenna must be installed in an open position. Satellite signals from GPS antennas may be weakened if explosion-proof or insulation film is installed on the windshield. In such cases, it is recommended to install a GPS antenna outside the vehicle.

GPS Antenna Installation

Installation of Antenna

Recommend installing the GPS antenna on dashboard or rear shelf. The antenna should be installed on leveled surface facing the sky to prevent blockage of radio waves as little as possible. Vehicle equipped with tempered glass or tint may weaken the receiving signal of the GPS antenna. Thus, recommend installing the antenna outside of the vehicle.

GPS Installation Guide

- Before affixing the GPS antenna, please ensure using the suitable cleaner to clean the designated surface. After cleaning, tear off the back of the tape and press to place the GPS antenna.
- Remove the side cover, move the cable through the storage box until it reaches the control panel of the machine. The cable needs to be fixed with a cable tie.
- Connect the GPS antenna's plug to the machine

Notes

- Please ensure the system power is off when connecting to the GPS antenna.
- Please do not shorten or extend the GPS cable. Altering the length of the cable may result in short circuit or malfunction that may damage the product.
- The antenna should be installed on a leveled surface where radio waves will be blocked as little as possible, otherwise it will affect the accuracy of navigation.

Setting

Click the setting icon "  " in the home page to enter the setting interface. As shown in the figure:

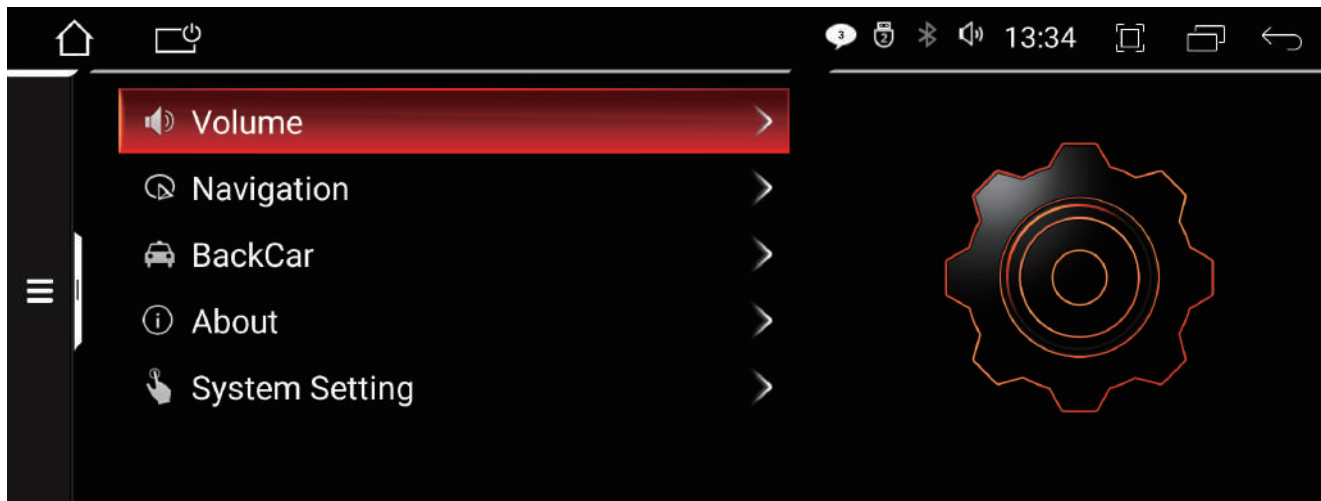

About-Factory Setting

About

Click "About " in the setting interface to enter the interface shown in the figure below, and click the green arrow behind the version information to upgrade the corresponding software.

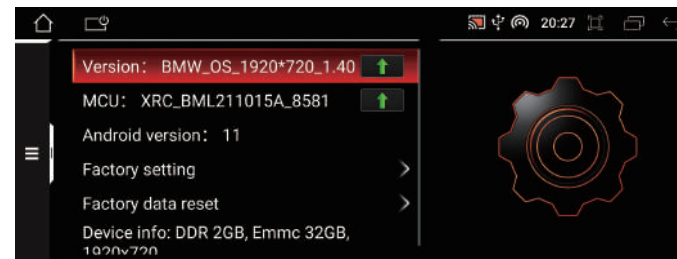

Factory setting

The password of "factory setting" is [8888].



Factory Setting

Enter the password [8888] to enter the "factory setting" interface, and move the option bar up and down to find the required setting. You can set the vehicle resolution (NBT, CIC, CCC, no original vehicle interface), startup logo, original vehicle sound switching mode, etc.

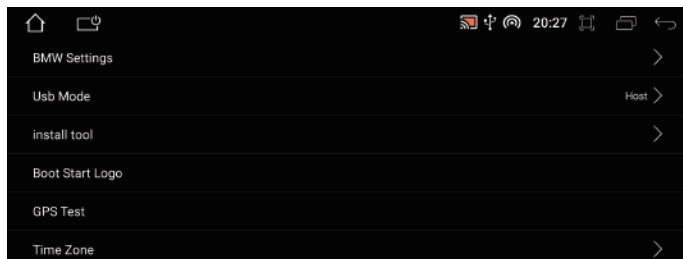

Front door & Rear door

If you open the left front door or the right front door and an error appears on the screen, you can click the button here “”

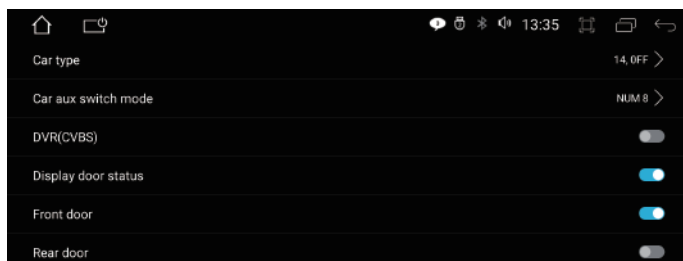

Boot Start Logo

Steps are as follows:

1. Create a new [logo] folder on the USB flash disk, and put the pictures you want to set as the boot logo into the [logo] folder.
2. The resolution is 1280 * 480, and the best format is BMP and PNG.
3. Insert the USB flash disk into the USB interface of the machine, enter the main interface → settings → About → Factory Settings, input password 8888 → Boot Start Logo → USB → long press and hold the image you want to set as the boot logo.

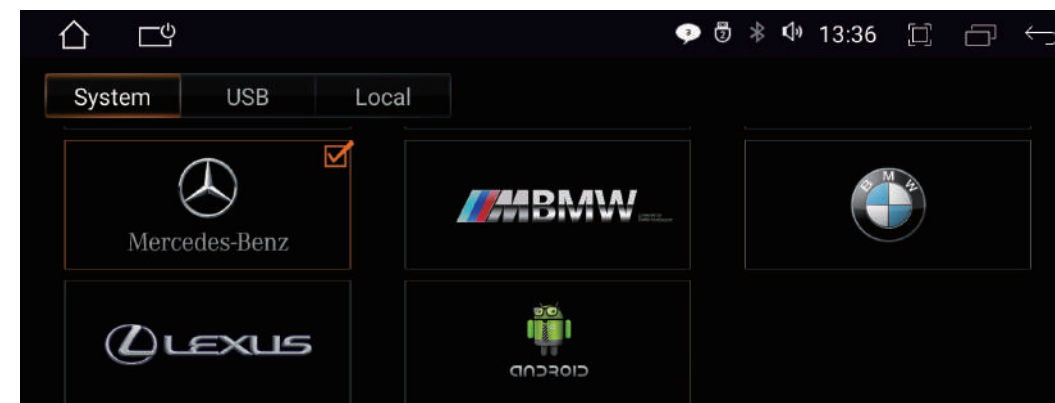

Note:

The system also has its own boot logo image for you to choose from

System Setting

Click Settings → System setting, Move the options bar up and down to find the desired settings. You can connect the network, adjust the display brightness, view the storage space, set the system language and time, and so on.

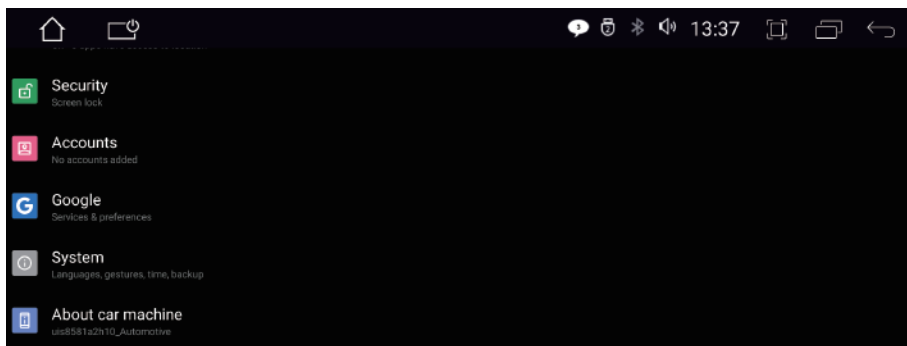
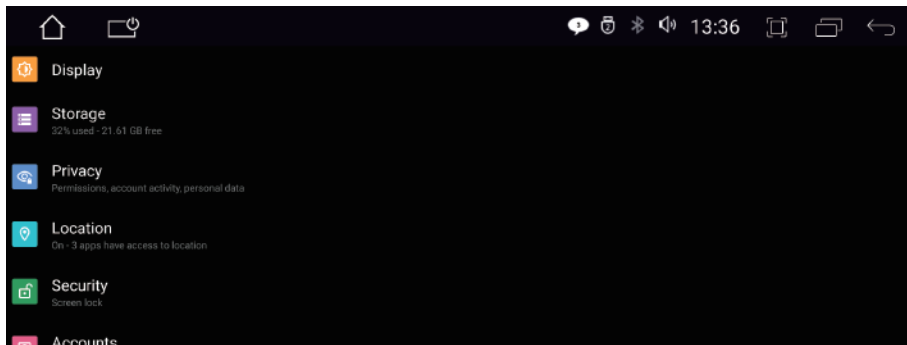

System Setting

Network & Internet

Search for Wi Fi hotspots you want to connect to. Enter the password, touch the connection, and complete the Wi Fi connection

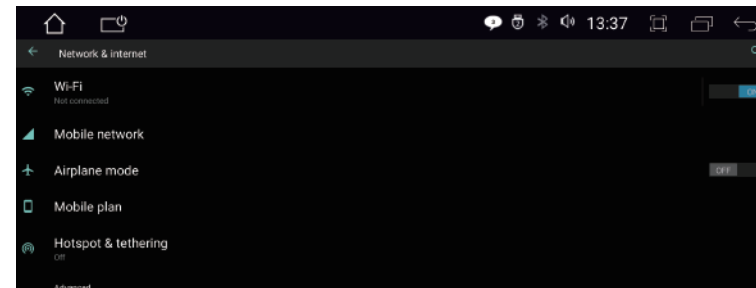

Apps & notifications

You can change some permissions of the app here.

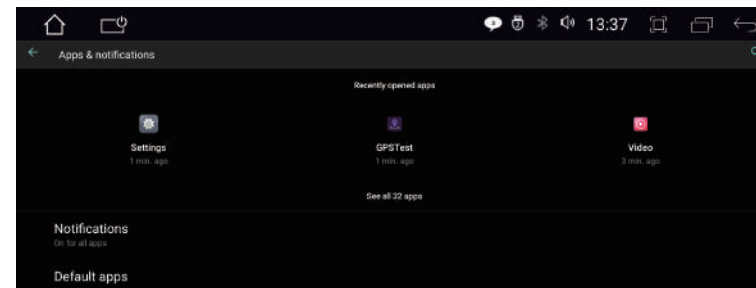

System Setting

System

Here you can change the language and input method, date and time, system updates, view machine information, and so on

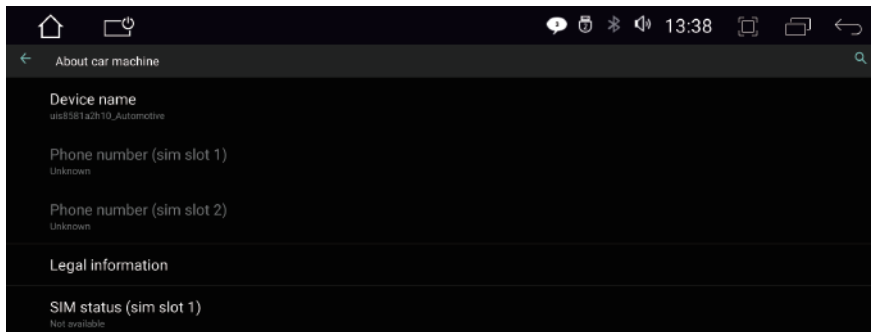
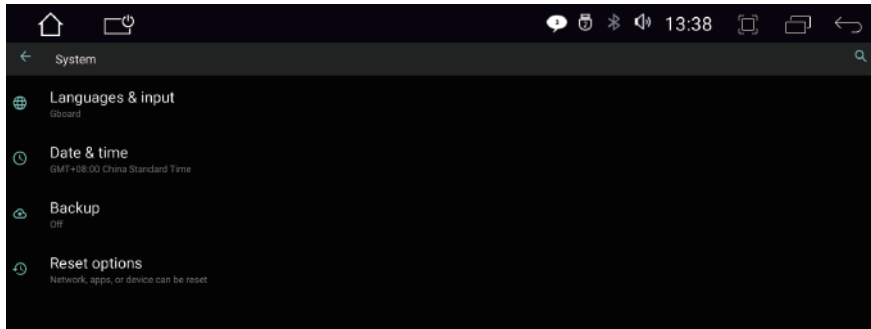

4G Mirco SIM Card

Band information

LTE-FDD	B1/B3/B5/B8
LTE-TDD	B34/B38/B39/B40/B41
WCDMA	B1/B8
GSM/EDGE	900/1800MHZ

Specifications

Operating Voltage	DC12V
Maximum Operating Current	≤10A
Operating Temp	-20 °C + 60 °C
Storage Temp	-30 °C + 70 °C
Operating Humidity	45% - 80%(Relative humidity)
Storage Humidity	39% - 80%(Relative humidity)
Video Formats	Supports AVI, MKV, MP4, WMV, RMVB, MPG...all Android videos formats, Web video and 1080P video.
Audio Formats	Supports MP3, WMA, WAV, AC3, OGG, FLAC, Web audio etc.
Picture Formats	Supports JPEG, BMP, PNG, TIFF etc.
Wi-Fi Specifications	
Voltage Support	Vcc_3.3V
Support Standard	IEEE802.11B/g/n compatible WLAN
Interface Type	USB 2.0
Frequency Range	2.4-2.484GHz
Modulation	OFDM/DBPSK/DQPSK/CCK

FAQ

If you encounter the following problems, please refer to this troubleshooting guide for a quick solution. If the problem still exists, it is best to contact a professional or contact our customer service for further help. Do not disassemble the machine without proper advice.

How to change the language?

Settings → System Setting → System → Language & input → Language

How to set the time and date?

Settings → System Setting → System → Date & time

Blank screen / unable to power on?

Please press the first button in the car or reconnect the power cord.

Please check whether the car has a stable DC12V voltage?

Please check whether the car fuse is burnt out?

Please reconnect the batt + / ACC / GND line on the power line of the Android navigation machine to the batt + / ACC / GND line of your car.