



Anton Paar

Measure
what is measurable
and make measurable
that which is not.

Galileo Galilei (1564-1642)

Instruction Manual and Safety Information

ViscoQC 300

Rotational Viscometer

(Original Instruction)

Software Version: 1.00.xx

Instruction Manual and Safety Information

ViscoQC 300

Rotational Viscometer

(Original Instruction)

Software Version: 1.00.xx

Disclaimer

This document may contain errors and omissions. If you discover any such errors or if you would like to see more information in this document, please contact us at our address below. Anton Paar assumes no liability for any errors or omissions in this document.

Changes, copyright, trademarks etc.

This document and its contents may be changed or amended by Anton Paar at any time without prior notice.

All rights reserved (including translation). This document, or any part of it, may not be reproduced, changed, copied, or distributed by means of electronic systems in any form (print, photocopy, microfilm or any other process) without prior written permission by Anton Paar GmbH.

Trademarks, registered trademarks, trade names, etc. may be used in this document without being marked as such. They are the property of their respective owner.

Further information

Published and printed by Anton Paar GmbH, Austria
Copyright © 2018 Anton Paar GmbH, Graz, Austria

Address of the instrument producer: Anton Paar GmbH
 Anton-Paar-Str. 20
 A-8054 Graz / Austria – Europe

 Tel: +43 (0) 316 257-0
 Fax: +43 (0) 316 257-257
 E-Mail: info@anton-paar.com
 Web: www.anton-paar.com

Date: December 2018

Document number: C78IB007EN-B

Contents

1 Safety Instructions	6
1.1 General Safety Instructions.....	6
1.2 Special Safety Instructions.....	7
1.3 Safety Signs on the Instrument.....	7
1.4 Conventions for Safety Messages	7
1.5 Remaining Risks	7
2 ViscoQC 300 - An Overview	8
2.1 Intended Use of the Instrument.....	8
2.2 Functional Components	9
3 Checking the Supplied Parts	10
4 Installing and Switching On the Instrument	11
4.1 Installation Requirements	11
4.2 Installation.....	11
5 Operating the Instrument	16
5.1 Log on/off and User Management	16
5.2 The Display	17
5.3 Spindle, Spindle Guard, DIN Adapter	19
6 Adjusting and Calibrating	19
6.1 Calibrating.....	19
6.2 Adjusting	20
7 Measuring Settings, Methods and Modes	22
7.1 Measuring Speeds – the Speed List.....	22
7.2 Measurement Methods	22
7.3 Measurement Modes	24
7.4 Spindles and Measuring Systems.....	25
7.5 Instrument Setup.....	26
8 Performing Measurement	28
8.1 Preparation and Sample Filling.....	28
8.2 Measurement Procedure	29
8.3 Measured Data	30
9 Cleaning	31
9.1 Standard Cleaning	31
9.2 Wetted Parts	32
10 Maintenance Work	32
10.1 Software Maintenance	32
10.2 Adjusting the Head Retention	33
10.3 Storing and Transporting the Instrument	33
Appendix A: Technical Data	34
Appendix B: Spindle Overview	35
Appendix C: Menu Tree	36
Appendix D: Trouble shooting	39

1 Safety Instructions

- Read this instruction manual before using ViscoQC 300.
- Follow all hints and instructions contained in this instruction manual to ensure the correct use and safe functioning of ViscoQC 300.
- The manual is a part of the product. Keep this manual for the complete working life of the product and make sure it is easily accessible to all people involved with the product. If you receive any additions or revisions to this manual from Anton Paar GmbH, these must be treated as part of the manual.

1.1 General Safety Instructions

Liability

- This instruction manual does not claim to address all safety issues associated with the use of the instrument and samples. It is your responsibility to establish health and safety practices and determine the applicability of regulatory limitations.
- Anton Paar GmbH only warrants the proper functioning of ViscoQC 300 if no adjustments have been made to the mechanics, electronics, and firmware.
- Only use ViscoQC 300 for the purpose described in this instruction manual. Anton Paar GmbH is not liable for damages caused by incorrect use of ViscoQC 300.

Installation and use

- ViscoQC 300 is **not** an explosion-proof instrument and therefore must not be operated in areas with risk of explosion.
- The installation procedure should only be carried out by authorized personnel who are familiar with the installation instructions.
- Do not use any accessories or spare parts other than those supplied or approved by Anton Paar GmbH (see section 3).
- Make sure all operators are trained to use the instrument safely and correctly before starting any applicable operations.
- In case of damage or malfunction, do not continue operating ViscoQC 300. Do not operate the instrument under conditions which could

result in damage to goods and/or injuries and loss of life.

- Check ViscoQC 300 for chemical resistance to the samples and cleaning agents.

Maintenance and service

- The results delivered by ViscoQC 300 not only depend on the correct functioning of the instrument, but also on various other factors. We therefore recommend you have the results checked (e.g. plausibility tested) by skilled personnel before consequential actions are taken based on the results.
- Service and repair procedures may only be carried out by authorized personnel or by Anton Paar GmbH.

Disposal

- Concerning the disposal of ViscoQC 300, observe the legal requirements in your country.

Returns

- For repairs send the cleaned ViscoQC 300 to your Anton Paar representative. Only return the instrument together with the filled out RMA (Return Material Authorization) and the form "Safety Declaration for Instrument Repairs". Please download the Safety Declaration form from our website www.anton-paar.com.
- Do not return instruments which are contaminated by radioactive materials, infectious agents or other harmful substances that cause health hazards.

Precautions for highly flammable samples and cleaning agents

- Observe and adhere to your national safety regulations for handling the measured samples (e.g. use of safety goggles, gloves, respiratory protection etc.).
- Only store the minimum required amount of sample, cleaning agents and other inflammable materials near ViscoQC 300.
- Do not spill sample/cleaning agents or leave their containers uncovered. Immediately remove spilled sample/cleaning agents.
- Make sure that the setup location is sufficiently ventilated. The environment of ViscoQC 300

must be kept free of inflammable gases and vapors.

- Connect ViscoQC 300 to the mains via a safety switch located at a safe distance from the instrument. In an emergency, turn off the power using this switch instead of the power switch on ViscoQC 300.
- Supply a fire extinguisher.
- Ensure the sufficient supervision of ViscoQC 300 during operation.

1.2 Special Safety Instructions

- Do not use ViscoQC 300 to measure fluids of the IIC group according to EN 60079-14, such as e.g. carbon disulfide or acetylene.
- Move the head up and down using the hand wheel on the head.
- To move or lift ViscoQC 300, grasp the rod of the stand with one hand and the foot of the stand with the other hand. Do not take ViscoQC 300 by the measuring head, nor by the spindle guard.
- Carry ViscoQC 300 in front of you and keep it close to your body.
- Disconnect spindles or measuring systems by pulling them sideways. This reduces strain on and wear of the internal low-friction bearing.

1.3 Safety Signs on the Instrument

No safety sign on ViscoQC 300.

Optional equipment – Stainless steel bath cover for 600 mL beaker (use with optional bath thermostat):

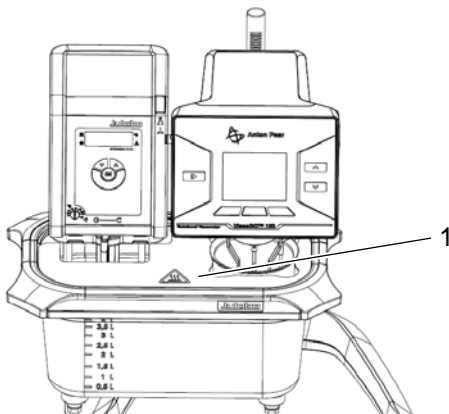

1 Warning Hot Surface

Fig. 1: Safety sign on optional stainless steel bath cover



WARNING

Risk of injury, health risk

If measuring at high temperatures, the bath cover and bath liquid are hot. Keep clear of the bath tank. Wait until the bath liquid has reached an uncritical temperature before you handle any parts. Use suitable protective equipment. Adhere to all safety instructions in the bath's documentation.

1.4 Conventions for Safety Messages

The following conventions for safety messages are used in this manual:



DANGER

Description of risk.

Danger indicates a hazardous situation which, if not avoided, **will** result in death or serious injury.



WARNING

Description of risk.

Warning indicates a hazardous situation which, if not avoided, **could** result in death or serious injury.



CAUTION

Description of risk.

Caution indicates a hazardous situation which, if not avoided, could result in minor or moderate injury.

NOTICE

Description of risk.

Notice indicates a situation which, if not avoided, could result in damage to property.

1.5 Remaining Risks

Dropping the instrument might cause injuries to your feet.

Knocking over the ViscoQC 300 might cause damage to other lab equipment due to the instrument's weight. If measuring hazardous samples, take care not to knock over the sample vessel. The spillage of hazardous samples represents a serious health risk.



CAUTION

Risk of injury, health risk

Using chemically or biologically hazardous chemicals as samples or cleaning liquids is a health risk. Measuring at high ($> 40\text{ }^{\circ}\text{C}$) or low temperatures ($< 0\text{ }^{\circ}\text{C}$) is a health risk. The above risks could cause serious injuries unless special precautions are taken. Consult the material safety data sheets of the sample substances and cleaning liquids. Operate the ViscoQC 300 in a fume hood and make sure to use suitable protective equipment.



Wear protective gloves

Wear protective gloves when handling samples and cleaning liquids.



Wear safety goggles

Wear safety goggles when handling samples and cleaning liquids.



Use protective clothing

Use protective clothing when handling samples and cleaning liquids.

2 ViscoQC 300 - An Overview

ViscoQC 300 is a rotational viscometer that determines the dynamic (apparent) viscosity as multiple points. The instrument serves for quality control of liquid samples such as solvents up to semi-solid substances such as lotions. It returns instant results on a built-in color screen. Measured data are stored in the data memory and can be printed or exported as .csv or .pdf format. LIMS Bridge Software allows the data transfer for implementation in LIMS.

The Toolmaster™ system automatically recognizes connected measuring systems (spindles and cylinder systems). A Pt100 temperature sensor allows to monitor the temperature of the measured sample.

A magnetic coupling serves as connection for spindles or measuring systems. This reduces the risk to bend or damage parts.

Optional software packages for additional functions:

- V-Curve: online graph of real time measurement data, programmability of up to 50 steps, mathematical models and yield stress determination with vane spindles (see also p. 18)
- V-Comply: joint with pharma qualification package for perfect traceability and to fulfill regulations of FDA 21 CFR part 11

If ViscoQC 300 has been ordered together with a software package, you need not activate it upon delivery. If upgrading existing devices, you get an un-

lock code. The first 8 characters of the code are the serial number of the ViscoQC 300. See "Activate Software Packages", p. 38.



Fig. 2: Rotational viscometers: ViscoQC 300

2.1 Intended Use of the Instrument

ViscoQC 300 is an instrument for determination of dynamic viscosity. It can measure a wide range of viscous and viscoelastic samples within the specified measuring range. There are three different models available for different viscosity measuring ranges (L – low, R – regular, and H – high). These ranges depend on the torque range of the model. See appendix A.

NOTICE

Risk of damage to the instrument

- Do not test a sample if you do not know which cleaning liquid removes this sample. Make sure the wetted parts of ViscoQC 300 are chemically resistant to any tested sample or cleaning liquid.
- Do not test any samples which harden or solidify during the time they are in contact with parts of ViscoQC 300.
- Do not test any samples that are specified in section 1.2.

Turn the hand wheel (3) to move the measuring head up or down. If you are in front of ViscoQC, turn the hand wheel towards you to lower the head; turn the hand wheel away from you to lift the head.

2.2 Functional Components



- 1 ViscoQC 300 measuring head
- 2 Measuring head retention
- 3 Hand wheel – move the measuring head up or down
- 4 Rod of stand
- 5 Foot of stand
- 6 Leveling screws – level the ViscoQC
- 7 Spindle coupling (magnetic)
- 8 Touch screen

Fig. 3: ViscoQC 300 – front view

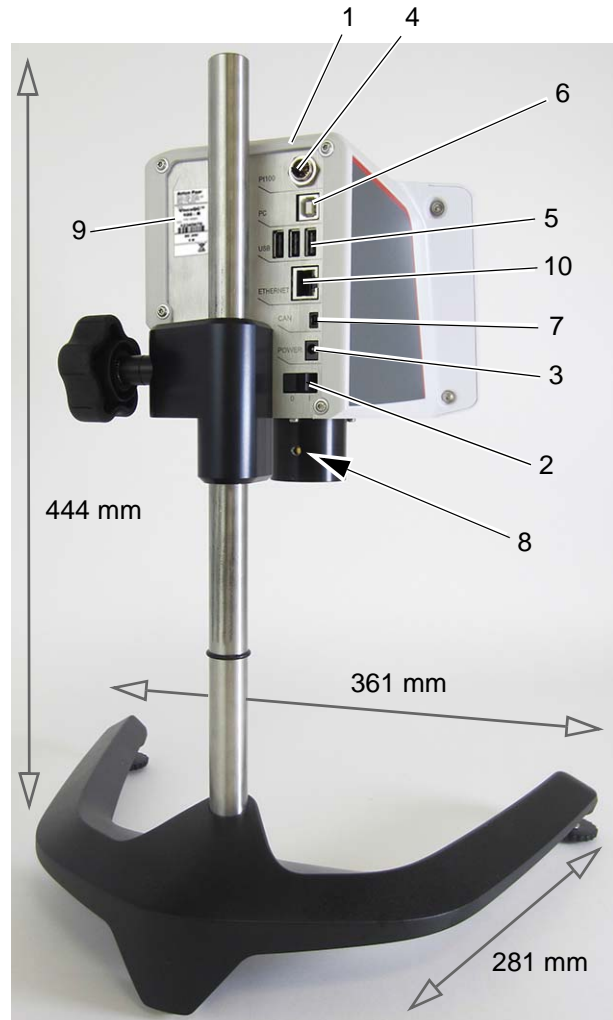

- 1 ViscoQC 300 measuring head
- 2 Power switch
- 3 Power inlet
- 4 Interface for Pt100 temperature sensor
- 5 USB interface (3x) – to connect optional 2D bar code reader, external keyboard, or USB printer for data export to USB device. Also for firmware update from storage device.
- 6 PC interface (for V-Collect Software)
- 7 CAN interface for optional accessories
- 8 Mount for spindle guard or measuring cup on the measuring flange
- 9 Type plate with serial number
- 10 Ethernet interface – for connection to a network printer or LIMS bridge software

Fig. 4: ViscoQC 300 – rear view

3 Checking the Supplied Parts

ViscoQC 300 was tested and packed carefully before shipment. However, damage may occur during transport.

1. Keep the packaging material (box, foam piece, transport protection) for possible returns and further questions from the transport and insurance company.
2. Check the delivery for completeness by comparing the supplied parts to those noted in table 1.
3. If a part is missing, contact your Anton Paar representative.
4. If a part is damaged, contact the transport company and your Anton Paar representative.

TIP: Concentric cylinder systems, the double-gap system and other accessories have to be ordered separately and are not included in the below table. Check these parts using the delivery note.

Table 1: Supplied Parts





Symbol	Pcs.	Article Description	Mat. No.
	1	ViscoQC 300 - L ^a or ViscoQC 300 - R ^a or ViscoQC 300 - H ^a (with transport protection for magnetic coupling – see arrow)	105023 105024 105025
	1	Viscometer stand (see above picture)	189184
	1	Set L-spindles – supplied with ViscoQC 300 - L: consisting of 4 spindles L1 to L4	190845
		or	
		Set RH-spindles – supplied with ViscoQC 300 - R / H: consisting of 6 spindles RH2 to RH7	190846
	1	Set of torque range stickers L / R / H <i>Find this set on the front page of this instruction manual.</i>	189804
	1	Power supply unit with connection cable to ViscoQC (comes in a cardboard box – a reminder to remove the ViscoQC transport protection covers the box)	186547

Table 1: Supplied Parts

Symbol	Pcs.	Article Description	Mat. No.
	1	one of the following power cords Power cord EUR Power cord USA Power cord GBR Power cord Switzerland Power cord China Power cord Brazil Power cord Thailand Power cord Australia	52112 52656 61865 93408 27011 130117 79730 173747
	1	USB cable	168165
	1	Standard Operating Procedure (SOP)	
	1	Instruction Manual and Safety Information ^b	

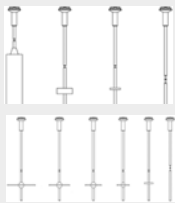
a See appendix A for specifications of viscosity and torque measuring range.

b Find this as well as further documents regarding the ViscoQC on the website of the Anton Paar GmbH through the link: <https://www.anton-paar.com/us-en/services-support/document-finder/>. Register, log in, and go to "Service & Support > Document Finder > Product group: Viscometer > Products: ViscoQC".

4 Installing and Switching On the Instrument

4.1 Installation Requirements

Read the Safety Instructions in section 1. Find all Technical Data and required ambient conditions in appendix A.

NOTICE

Risk of damage to the instrument

The correct line voltage and line frequency must be available (AC 100 to 240 V, 50/60 Hz). If large voltage fluctuations are to be expected, we recommend using a constant voltage source (UPS).

To ensure temperature stability and trouble-free measurement never locate your instrument:

- next to a heating facility
- near an air conditioning, ventilation system or an open window
- in direct sunlight

Keep the instrument away from magnetic fields.

4.2 Installation

4.1.1 Environmental Requirements

The setup location and surroundings should meet the requirements of a typical laboratory.

Place the instrument on a stable, flat, leveled lab desk, which is free of vibrations.

1. Carefully unpack ViscoQC 300. Lift it out of the box by the rod of the stand and place it on the lab desk.
2. Unscrew the transport protection from the magnetic coupling by turning it to the left (Fig. 5). **Keep the transport protection for later use.**

4 Installing and Switching On the Instrument

- If required, place the correct torque range sticker (L, R, or H) clearly visible on the ViscoQC measuring head (e.g. on top or on the side).



1 Transport protection

Fig. 5: Removing the transport protection

- Connect optional equipment (e.g. printer) to the corresponding interfaces. See section 2.2.
- Allow the equipment to reach ambient temperature before installation. This is very important if the equipment has been stored or transported at lower temperatures.

4.2.1 Connecting and Switching on ViscoQC 300



WARNING

High voltage. Risk of injury or death

- Connect the power supply unit of ViscoQC 300 to the mains via protective earthing only.
- Never connect the power supply unit to the mains via protective separation or protective insulation.
- Make sure that the non-fused earth conductor of the power cord is connected to earth.

- Connect the power supply unit of ViscoQC to the mains using the supplied power cord.
- Connect the power supply unit and the power inlet of ViscoQC (section 2.2).
- Switch the instrument on using the power switch on the rear of the measuring head. ViscoQC boots.

4.2.2 Level/Zero Adjustment

- Wait that ViscoQC initializes.
- Level ViscoQC by turning the two leveling screws on the foot of the stand. An adjusted, built-in leveling chip serves as reference. Center the colored dot in the colored ring (see Fig. 6, steps A to C).

- A: RED – Adjust the two leveling screws.
 B: YELLOW – Wait; the instrument stabilizes.
 C: GREEN – ViscoQC is correctly leveled.
 Tap <OK> to continue.

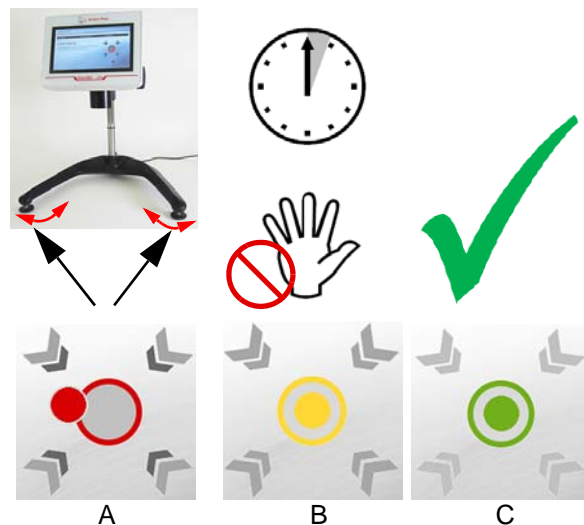

Fig. 6: Leveling ViscoQC

If you skip the level adjustment, you directly jump to the main screen. It is not possible to measure, you can only open the menu and quick access functions.

Zero Adjustment

For correct function of ViscoQC the instrument determines the start position for zero torque without load (i.e. spindle or measuring system).

- ViscoQC prompts you to remove the spindle. Tap <Next> to continue.
- ViscoQC performs a Zero Adjustment. Do not touch the instrument. Once the Zero Adjustment is finished, tap <OK>. ViscoQC displays the Autozero Offset.

In case you abort the Zero Adjustment by tapping <Abort> and then <Cancel>, you can access main screen and menu, but cannot perform measurements.

- ViscoQC is now ready for operation. Connect a spindle or measuring system.

You can start a Level/Zero Adjustment any time from the menu. Tap <Menu> and select "Adjustments >Level/Zero Adjustment".

TIP: Perform these adjustments every time you moved ViscoQC. Every time ViscoQC boots, the Level Adjustment screen comes up.

4.2.3 Mounting Additional Components

In case you use additional or optional equipment, connect and/or install it as follows.

4.2.3.1 Pt100 sensor

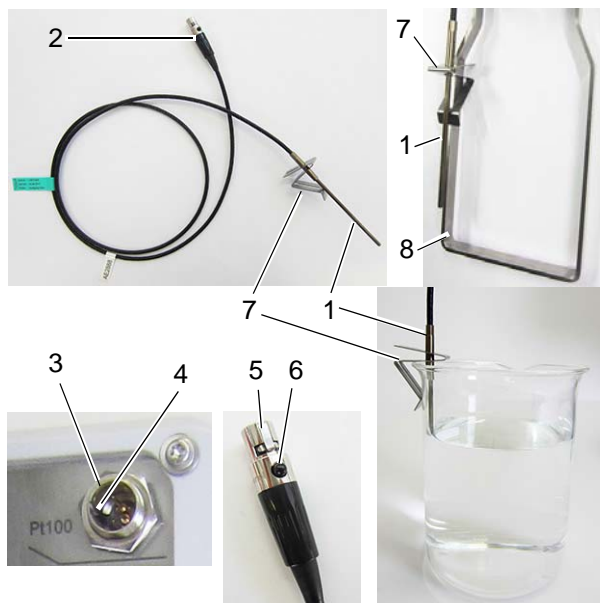

- 1 Pt100 sensor
- 2 Pt100 plug
- 3 Pt100 socket
- 4 Recess for Pt100 guide
- 5 Pt100 guide
- 6 Release knob
- 7 Clip for fixing the Pt100 sensor
- 8 Spindle guard (e.g. R)

Fig. 7: Setting up the Pt100 Sensor

Plug the optional Pt100 sensor into the connector on the rear of ViscoQC. Fit the guide on the Pt100 plug into the recess of the socket. Immerse the Pt100 sensor in the sample vessel. Fix the Pt100 sensor on the rim of the sample vessel or on the guard with the metal clip. The sensor must not touch the spindle. If required, perform a temperature calibration and set a temperature offset (section 6.2.2).

To disconnect the Pt100 cable, press the **release knob** on the plug and pull out the plug.

4.2.3.2 Data Export via LIMS Bridge software

For data export via LIMS Bridge use the Ethernet interface and an Ethernet cable (Mat. No. 18597).

Plug the Ethernet cable into the Ethernet interface of ViscoQC. Connect the other end of the cable to the PC. ViscoQC 300 requires the following settings:

Deactivate LIMS Import and Check Data Import (not supported with ViscoQC). For data export, use data format PDF, CSV, or LIMS. Do not use XLS or TXT format.

- If V-Comply software package is NOT activated, do NOT activate the audit trail settings.
- If V-Comply is activated: Use data format PDF.

TIP: Activating PDF reports significantly influences the GUI performance of ViscoQC 300. It is therefore recommended to use format CSV if possible. For PDF reports, preferably perform a manual export.

4.2.3.3 Printer

For printout of measurement results, Anton Paar offers the Label Printer USB Dymo® 450 with a label size of 28 mm x 89 mm. The label shows ViscoQC model and serial number, spindle/measuring system info (+ unique ID), measurement mode and data, if applicable: up to 3 warning/error numbers (see appendix D).

First, connect the printer cable to the printer. Then plug the printer cable into the USB interface of ViscoQC. Connect the printer to the mains. Follow the safety and operating instructions of the printer's documentation.

TIP: If "Automatic Printout" is active and Dymo LabelWriter 450 set as target, ViscoQC automatically prints when a measurement is finished. For multi-point measurements only recommended for a maximum of 5 points.

4.2.3.4 V-Collect Software

You can connect ViscoQC to a **PC with USB interface** and export the measurement results directly to MS Excel via V-Collect Software.

Plug the supplied USB cable into the PC interface and to ViscoQC. Install V-Collect Software (macro-based MS Excel Add-in). You need administrator rights on the PC in question.

TIP: Always use the latest version of V-Collect.

NOTE: It is not possible to use automatic printout via V-Collect for measurements, which use steps (applies to V-Curve software package only).

Download V-Collect Software here:

www.anton-paar.com/viscoqc-webpack



Fig. 8: QR code for download of V-Collect package

PC Software Requirements:

- Windows 7 or newer
- Microsoft Excel 2010 or newer

Additionally, you might need to install a driver for the USB-RS232 chip of ViscoQC.

The driver is included in the V-Collect Software package and automatically installed upon connection of ViscoQC to PC. If you get a message that the driver software could not be installed automatically, find the installer in the package (*CDM2 1228_Set-up.exe*) and install it manually. The following link guides you to an installation guide for your operating system (also find the most recent driver software):

<http://www.ftdichip.com/Drivers/D2XX.htm>



Fig. 9: QR code for download of chip driver

TIP: Install V-Collect and the driver software from a local drive. Extract all files of the download package properly. Do not just double-click on the files in the package. Run programs (*.exe) as "Administrator".

Installation and Start of V-Collect Software

If an older version of V-Collect is already installed on the PC, uninstall this version first (see below).

1. Create a new folder on your hard disk and name it "V-Collect" (e.g. "C:\V-Collect").
2. Copy the downloaded file "V-Collect.xla" into folder "V-Collect".
3. Start Microsoft Excel. Click the <Office> icon

(upper left corner) and select **Excel Options**. Select category **Add-Ins**.

4. Select "**Excel Add-ins**" in the drop-down box "**Manage**" and click <Go...>. The "Add-ins" dialog opens.
5. Click <Browse> and select file "V-Collect.xla" from the "V-Collect" installation folder. V-Collect is added to the list of available Add-ins.
6. Tick the "V-Collect" check box. Click <OK>.
7. Read the Anton Paar software license agreement, select a language (applies to the V-Collect surface only), and confirm with <I accept>.
8. Confirm the message of success with <OK>. The Add-in is now installed.
9. Start Microsoft Excel. Select tab "Add-Ins". The menu bar shows "V-Collect".

If you click "V-Collect" you see the following options:

- Start Data Collection
- Print Settings (scaling and orientation)
- Save Log-File... (for service purpose only)
- Stop Data Collection (grayed out, becomes active after start of data collection)

10. Select "Start Data Collection". In the start dialog, select a folder and name for your data file.

TIP: Assign a new name to the file. Do not use the default name to avoid accidentally overwriting your data when opening V-Collect another time.

Click <Change...> in area "Filename" to browse.

11. In area "Settings", select the correct virtual COM port for V-Collect. Once the chip driver has been installed and ViscoQC is connected, you find the number of the virtual COM port in the PC's Device Manager under "Ports (COM & LPT)".

Click <Change...>. Select ViscoQC as device and the right COM port. Click <OK>.

You should export data as "formatted". Option "unformatted" is a backup, if the formatted export fails.

12. Click <Start>. V-Collect waits for data from ViscoQC. When a measurement finishes, ViscoQC sends the data to MS Excel. Data layout is the same for all measurement modes. Each measurement sends a complete set of data including device configuration and adjustment data (e.g. SCF, temperature offset). Column "Date/Time Received" gives **date and time of the PC** when the data were received.

TIP: Measurement data exported to V-Collect Software have uniform units, not the units as set in the instrument. Export language is always English.

- When finished, select "V-Collect > Stop Data Collection". Confirm closing of V-Collect with <OK> and save your measurement data file.

Uninstalling V-Collect Software

- Open Microsoft Excel. Click on **Add-Ins...** in the **Tools** menu. Deactivate the check box for "V-Collect". Click <OK>. Close MS Excel.
- Delete the file "V-Collect.xla" from your V-Collect installation folder on the hard disk.
- Open MS Excel. Click on **Add-Ins...** in the **Tools** menu. Click the "V-Collect" check box. Confirm the message (not found) with <Yes>.
- Close the "Add-Ins" window with <OK>. Close MS Excel.

4.2.3.5 Bath Thermostat

For basic temperature control of samples in 600 mL beakers or DIN measuring systems, use a bath thermostat. Recommended equipment:

- Julabo CORIO™ C-BT5 bath thermostat +
- Stainless bath cover for 600 mL beaker +
- Stand for Bath Thermostat CORIO™ C-BT5

- Mount the bath stand: Put ViscoQC on its side.

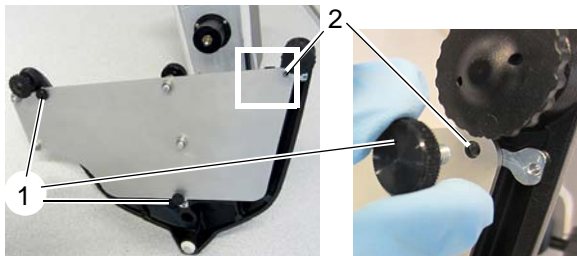

- Mounting screws of bath stand
- Thread on the foot of the ViscoQC stand

Fig. 10: Fixing the bath stand on the ViscoQC stand

- Hold the bath stand against the foot from below.
- Fit the three mounting screws into the threaded holes on the foot (through the holes of the bath stand). Tighten the mounting screws.

- Place the ViscoQC on its foot.

TIP: Install the bath thermostat as described in this **Instruction Manual**. For use with ViscoQC, the bath has to be set up other than described in the bath's instruction. See Fig. 11.

- Put the bath tank (3) on the bath stand (7). Fill the bath tank (3) high enough so that the bath liquid is approximately level with the sample in the beaker (6). Filling volume: approx. 4 L

- Place the cover (5) on top of the bath tank (3).
- Fill the beaker with sample. Place spindle, spindle guard (if in use), and optional Pt100 sensor in the beaker. Then insert the beaker (6).
- Connect the spindle. (If in use: mount the spindle guard). Place the ViscoQC measuring head (1) centric to the beaker (6).

DIN system: Prepare the bath, then mount the DIN system (section 8.1.2) on the ViscoQC. Adjust the measuring head to immerse the cup in the bath.

Recommended bath liquids

- Water plus algicide
- For high temperatures: suitable oils by Julabo <https://www.julabo.com/en/products/accessories/bath-fluids>



WARNING

Risk of injury, health risk

If you measured at high temperatures, the bath liquid and the bath cover are hot. Keep clear of the bath tank. Wait until the bath liquid has reached an uncritical temperature before you handle any parts. Make sure to use suitable protective equipment. Read and adhere to all safety instructions in the bath's documentation. Adhere to the instructions in section 1.

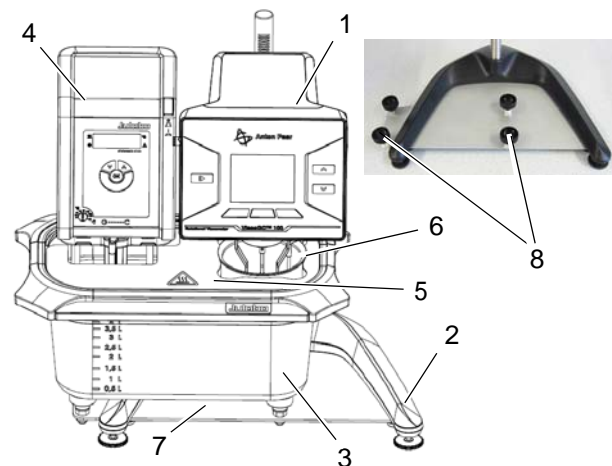

- ViscoQC
- ViscoQC stand
- Bath tank
- Control unit
- Stainless steel bath cover for 600 mL beaker
- Beaker with sample liquid
- Stand for bath thermostat CORIO™ C-BT5
- Positioners for feet of bath tank (4x)





Fig. 11: Heating bath installation for ViscoQC

5 Operating the Instrument

5.1 Log on/off and User Management

When delivered, the instrument is freely accessible without password. Three user accounts are factory preset. For the "administrator" user, the auto logon function is activated.

Table 2: Factory default user management

User	Password	User group	Group icon
Operator	operator	Operator	
Manager	manager	Manager	
Administrator	administrator	Administrator	
Service	-- service personnel only --		

TIP: It is recommended to replace the default passwords when setting the instrument into operation.

The menu tree (appendix C) shows the different levels of factory default user group rights. You cannot edit or delete default user groups.

Log on/off

1. Tap the user indicator (see Fig. 12) on the right side of the main screen's header.
2. Select your "User name", enter your "Password", and tap <OK>.

To log off, tap on the user indicator. Tap <Log off> in the logon dialog.

- If no user has auto logon rights, the user indicator changes its appearance to: 
- The instrument finishes the current measurement or measurement series, but does not accept any input until someone successfully logs on.
- If a user has auto logon rights, this user is automatically logged on.

User accounts

1. Tap <Menu> and select "Setup > User Management > User Administration".
2. Tap <New> to create a new user account or tap an existing user name to edit this user account.
3. Specify the following settings:
 - User name, User group, password (optional)
 - Activate/deactivate the user account
 - Activate/deactivate the "Auto logon"

You need administrator rights to create, edit, or delete user accounts. Maximum: 1000 user accounts

TIP: A user with a deactivated account cannot log on until the account is activated again. Users without administrator rights can only change their own password.

Naming and password rules

User names are not case sensitive. They must be at least one character long and can contain only characters from the ASCII table (letters, numbers and most special characters).

If you do not set a password, users can log on by selecting their user name from the user list.

Passwords must consist of at least one character and contain only characters from the ASCII table (letters, numbers and most special characters).

Passwords are case sensitive, i.e. "Anton Paar" and "anton paar" are treated as different entries.

Custom user groups

Tap <Menu> and select "Setup > User Management > User Group Administration".

Create new user groups by copying existing ones (based on the default user groups "manager" or "operator"). For custom user groups, grant access rights to the instrument's functions as needed.

Functions, for which access is customizable, include menu entries, the operating elements on the main screen, and additional entries, e.g. data export via LIMS Bridge.

You can export a summary of a user group's rights as .csv file (table format).

5.2 The Display

Main screen

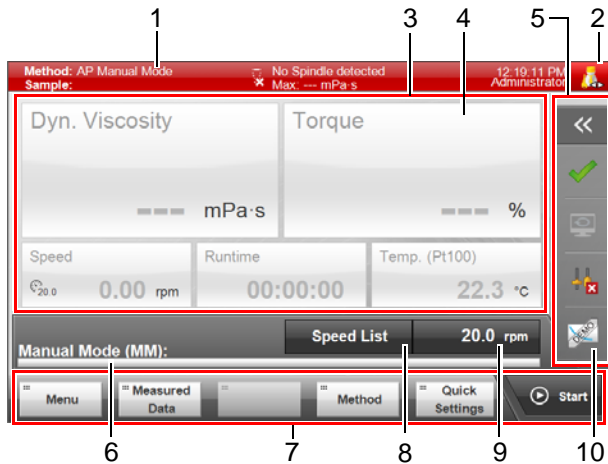

- 1 Header
- 2 User indicator
- 3 Content area
- 4 Output field
- 5 Quick access area
- 6 Progress bar
- 7 Buttons area
- 8 <Parameter> button: select a parameter (speed or shear rate) for the set value*
- 9 Input field for the set value*
- 10 DEMO button for optional software package (V-Curve)

* available for Manual Mode (MM) only

Fig. 12: Main screen – example: ViscoQC 300

Fig. 12 shows the main screen before measuring.

Header, left side: name of the currently active method and sample name/number.

Header, middle: spindle guard indicator, connected spindle/measuring system, maximum viscosity that is measurable with this spindle and speed

Header, right side: clock and user name/indicator (2) (shows which type of user is logged on)

The **content area** shows measuring parameters and data. It is constantly updated during measurement. The data are frozen after measurement until you tap the monitor button. The number and appearance of displayed fields depends on the selected method and display layout. Tap on output fields to assign them a different quantity.

The ideal torque range is between 10 - 100 %.

Torque < 10 % Dynamic viscosity and torque appear gray

Torque < 0 % " ---" no dynamic visc. shown









Torque < -10 % "<<<" shown as torque value

Torque > 100 % ">>>" shown as torque value

The **progress bar** displays the selected measurement mode. It shows information on the status of a measurement, while a counter on the right is active after starting a test.

Quick access area

Button	Function
	Opens the message list. A little yellow note shows the number of messages in the list, if any. The button changes its appearance depending on the current error status: Green OK sign: General instrument status and error status of measured sample are OK.
	A yellow warning sign signals a minor problem. If you ignore the warning message, measurement is still possible. Examples for warnings: - ViscoQC is not leveled. - The wrong guard is connected (<i>TruGuard™ enabled, NOT mandatory</i>) - V-Curve demo (30 days) is activated
	A red error sign signals a serious problem that prevents measurement. Examples for errors: - No valid Zero Adjustment. - The wrong guard is connected (<i>TruGuard™ is mandatory</i>)
	Unfreezes the screen after a finished measurement. The screen is frozen.
	The screen is unfrozen. A continuous reading of the current measuring values is shown.
	Spindle information Shows connected spindle/measuring system type plus details (factors, guard) <i>If the Toolmaster™ (section) is disabled: Selection of spindle/measuring system. See section 7.4.</i> "x" signals that no spindle is connected or selected.

Button	Function
  	<p>Demo button – activate V-Curve demo version (30 days). Demo trail is active and available. <i>If you deactivate the demo trail before it expires, you cannot activate it again!</i> Demo trail expired or deactivated The Demo button is not visible, if V-Curve full version has been activated.</p>
	<p>Displays information on using favorites: Tap  in the header of a dialog to add this dialog to the quick access area. Confirm or change the name. Tap <OK>. The info icon is visible only if the quick access area is expanded. It disappears when at least one favorite is in use.</p>
	<p>Expand or collapse the quick access area. All dialogs that you choose as favorites are stored here. Inside the quick access area:</p> <ul style="list-style-type: none"> - Browse:  - Reorder, rename or delete items:  <p>You cannot rename or delete the default functions (the ones explained above).</p>

Buttons area

- <Menu>: Opens the main menu
 - <Measured Data>: Opens the measurement data memory (multiple sample view)
 - <Quick Settings>: Opens the quick settings – even users without rights to edit method settings have access to the quick settings
 - <Method>: Select a method from the methods list (see section 7.2)
 - <Start/Stop>: Start/Stop (or abort) measurement
- Tap <Menu> to open the main menu (appendix C).

Menu screen

The functions of the buttons change when you enter a sub-menu.

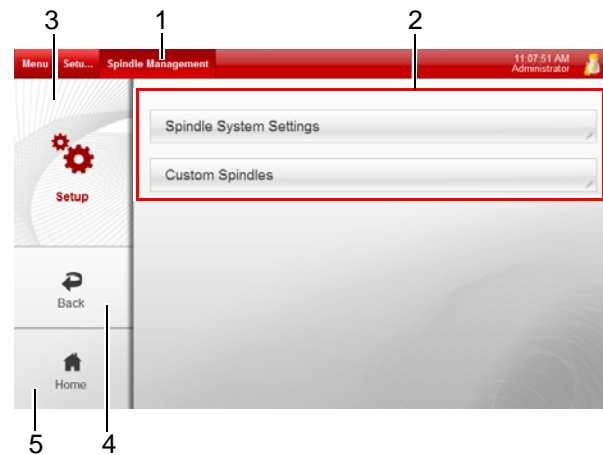

- 1 Header – shows the navigation path
- 2 (Sub)menu items
- 3 Current sub-menu
- 4 <Back> button – go one menu level up
- 5 <Home> button – go to main screen

Fig. 13: Menu screen – example: ViscoQC 300 setup

Menu navigation

- If you tap an item, you choose it or open a dialog. Buttons perform the functions written on them. Generally, <OK> serves to confirm your input and saves it. <Cancel> discards any input.
- In lists such as measurement or adjustment data and method settings, a long press (> 3 s) on an item frames the item red and displays additional options for this item (see Fig. 15). To return to the list without selecting an option, tap anywhere on the dark part of the screen.
- The button <More> also displays additional options.
- A capital "A" marks input fields: enter characters via virtual keys or via an optional USB keyboard.

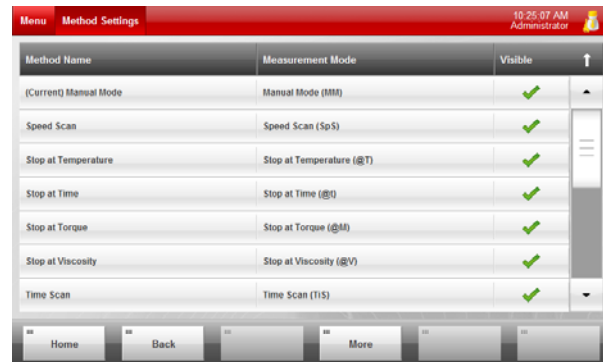

Fig. 14: List – example: Methods (Method Settings)

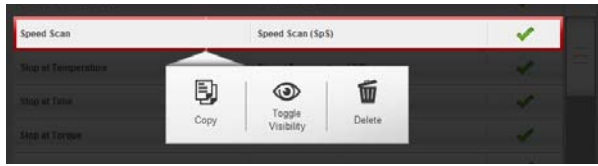

Fig. 15: Methods list – example: long press on a method

TIP: The <Home> button does not save your settings! In case you tap <Home> instead of <OK>, ViscoQC discards your input.

5.3 Spindle, Spindle Guard, DIN Adapter

5.3.1 Connecting and Removing a Spindle

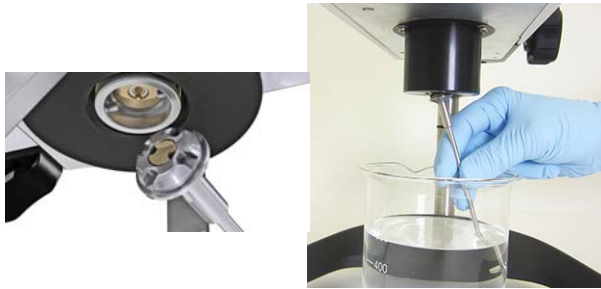

Fig. 16: Connecting/removing spindles

ViscoQC features a magnetic coupling. To connect a spindle, take the spindle shaft beneath the coupling and approach the coupling on the measuring head from below. Rotate the spindle slightly and wait until it clicks into place.

To remove a spindle, take the spindle shaft beneath the coupling and incline the spindle sideways. Then pull the spindle downwards.

5.3.2 Connecting and Removing a Spindle Guard or DIN Adapter

The spindle guard is fixed to the rear of the measur-

ing flange with an encoded screw showing the identification of the guard (**L** or **R**).

If using DIN measuring systems (concentric cylinders CC or double-gap DG) a DIN Adapter is fixed to the same thread. The fixing screw of a DIN Adapter is marked **D**.

ViscoQC can automatically detect the type of fixing screw (section).

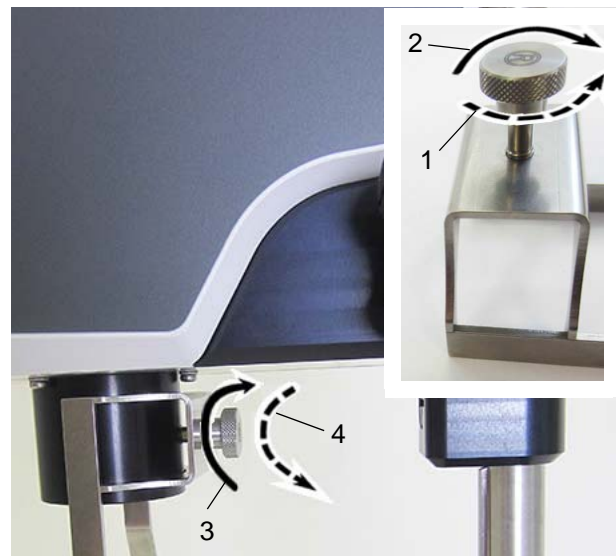

- 1 Removing the fixing screw from the holder
- 2 Inserting the fixing screw into the holder
- 3 Mounting a spindle guard / DIN adapter
- 4 Removing a spindle guard / DIN adapter

Fig. 17: Fixing screw for spindle guard / DIN adapter

The fixing screw is positioned in a threaded hole on the holder of the guard/DIN adapter. The screw cannot drop out accidentally due to the hole's thread. To remove the fixing screw from the holder you unscrew it.

Align the holder of the guard or DIN adapter with the rear of the measuring flange and fasten the screw (right thread). If you loosen the screw, hold the spindle guard/DIN adapter, so that it does not drop.

6 Adjusting and Calibrating

Adjusting means changing some hardware or software factors on the instrument that will have an influence on future measurement results. Calibrating means verifying that the instrument measures according to specifications: You perform a check measurement with a certified reference substance.

6.1 Calibrating

Verify that ViscoQC measures correctly at least once a month. Measure a certified reference substance. Determine how much the measuring result may deviate from the reference value. Then check the actual deviation. The allowed deviation depends

on the viscosity range, on the used spindle, on temperature stability and on the user's repeatability.

Equipment

- Reference standard liquid. Store such liquids in their *closed* original containers in cool and dark places. Check the expiry date.
- For standard spindles:
600 mL lab (low Griffin) beaker
- Pt100 temperature sensor, calibrated (section 6.2.2)
- Thermostat bath (stability ± 0.1 °C)
- Spindle, guard (if required)/measuring system

Remark: *Silicone standards < 30,000 mPa·s are recommended for 600 ml beaker.*

TIP: *Due to the small surface of the following spindles they are not recommended for calibration: L4, RH7. The reduced contact of liquid and spindle does not allow for the required accuracy.*

Preparation

Set the thermostat bath to the desired temperature. Refer to section 4.2.3.5 for using a bath thermostat. Fill the reference liquid into the sample vessel. Immerse the spindle (if in use: also the spindle guard) in the sample. Place the Pt100 sensor in the sample vessel. Mount the parts as described in section 5.3 and section 4.2.3.1. Place the sample vessel into the thermostat bath. Wait for temperature equilibrium. The displayed temperature must be stable (± 0.1 °C) before you start measuring. Let the spindle rotate at slow speed for better temperature distribution.

TIP: *If using a standard spindle that requires 500 mL of reference liquid, wait for at least one hour (from the moment the bath thermostat has reached the set temperature).*

Spindle L1 requires more than 500 mL filling volume, or place the beaker in a higher position (e.g. on a lab boy).

Calibration

It is recommended to use "TruMode" in method "Stop at Time (@t)", target time 60 s. Start measuring. Note down the result and determine the deviation from the reference value.

Determining the allowed deviation

The allowed deviation is the total of the lab repeatability plus the accuracy of the ViscoQC model (1 % of full scale range, see table 7) plus the uncertainty of the reference standard (see certificate).

If the calibration result exceeds the allowed deviation, calculate a new spindle correction factor (section 6.2.1)

6.2 Adjusting

Apart from Level Adjustment (section 4.2.2) and Zero Adjustment (section 4.2.2), you can adjust the following settings:

- Edit Spindle Correction (section 6.2.1)
- Edit Temperature Offset (section 6.2.2)

View adjustment data in the data memory. Select "Menu > Data Memory > Adjustment Data". Select the current adjustment report or the adjustment history, which traces all adjustments (including TruSine™ bearing checks) performed on this instrument. *Spindle correction factors are not listed, because they are stored on the Toolmaster™ chip of the spindle.* You can print, export or delete adjustment data.

6.2.1 Setting Spindle Corrections

The *Spindle Correction Factor (SCF)* serves to adjust the results you obtain with a certain ViscoQC setup to a (certified) reference value. This is necessary if a calibration yields a deviation that is greater than allowed (section 6.1).

The ViscoQC setup includes test speed, test temperature, spindle, sample vessel, and (if applicable) spindle guard.

TIP: *You can also adjust the SCF if you do not use the spindle guard for a spindle that requires it, or if the size of your vessel is other than recommended.*

The SCF is stored directly on the Toolmaster™ chip of the spindle. It is a spindle-specific parameter, not an instrument-specific one. Therefore, you can edit the SCF only if the Toolmaster™ is enabled (section 7.4.1.2).

Determining the SCF

NOTICE

Risk of erroneous measuring results

Work with great care in order to eliminate disturbing influences such as change of temperature, big air bubbles (especially with disc spindles), different immersion depth of the spindle, and different position of the sample vessel (centricity). Depending on the setup, the effect of these influencers may even exceed the effect of the SCF!

1. In order to determine the SCF, measure a reference substance with the desired setup. Proceed according to the instructions for calibrating (section 6.1).
2. Note down the measured viscosity.
3. Calculate the new SCF:

$$SCF_1 = SCF_0 \cdot \frac{\eta_R}{\eta_M}$$

SCF_1	...	new spindle correction factor
SCF_0	...	old SCF (= current SCF)
η_R	...	reference viscosity
η_M	...	measured viscosity

4. Enter the new SCF in the ViscoQC and repeat the measurement. The measuring results should now match the reference data.

Default SCF settings:

- SCF: 1.000
- SCF range: 0.100 to 1.400
- SCF resolution: steps of 0.001

Setting a spindle correction factor (SCF)

1. Tap <Menu> and select "*Adjustments > Edit Spindle Correction*".
2. ViscoQC shows the old (currently valid) SCF and further spindle information. Enter your input: see Menu navigation, p. 18.
3. Tap <OK> (2x) to save the SCF. ViscoQC prompts you to wait and displays a message when the data have been saved.

6.2.2 Setting a Temperature Offset

TIP: *With optional Pt100 sensor only.*

The Pt100 sensor comes ready for use (specifications table 9). If required, calibrate the sensor.

Temperature calibration

Required equipment

- Reference thermometer and sensor of better accuracy than the optional Pt100 sensor (see table 9, p. 34), e.g. Anton Paar MKT 10.
- Water or sample substance, provided the latter is not highly viscous.

Calibration

1. Fill a vessel with the above medium and let it reach a stable temperature. Ideally, calibrate the Pt100 sensor at or close to the usual measuring temperature.
2. Place the reference sensor and the Pt100 sensor side by side in the sample vessel. The sensor tips should be on the same level.
3. Wait for temperature equilibrium (approx. 10 minutes). The values should be stable.
4. Compare the temperatures displayed by ViscoQC and by the external thermometer. If required, set a temperature offset.

Default value: 0 °C. Allowed offset range:

±5.0 °C (±5.0 K) in steps of 1/10 °C (1/10 K) /
±9.0 °F in steps of 1/10 °F

Setting a temperature offset

1. Tap <Menu> and select "*Adjustments > Edit Temperature Offset*".
2. ViscoQC shows the current offset and an input field for the serial number of Pt100. Enter your input: Menu navigation, p. 18.
3. Tap <OK> (2x) to save the offset.

7 Measuring Settings, Methods and Modes

7.1 Measuring Speeds – the Speed List

ViscoQC 300 covers a speed range from 0.01 rpm to 250 rpm. It comes with 19 preset measuring speeds. You can select them from the *Speed List*. The list ranges from minimum to maximum preset speed. If not using the Speed List, measuring speeds are freely selectable within the speed range (see table 8).

Table 3: Speed List Example
(ViscoQC 300 - L, spindle L2)

Speed	Info	Max. Viscosity
0.3 rpm	L	100 Pa·s
0.5 rpm	R/H	60.0 Pa·s
:	:	:
100 rpm	R/H	0.30 Pa·s
200 rpm	C	0.15 Pa·s

- The *Speed List* is available on the main screen for methods using the Manual Mode (MM) or in the method settings.
- To select a speed, tap it.
- **Speed:** Measuring speed
- **Info:** Shows the ViscoQC model(s) for which this speed is standardized. *This is only for information, you can also measure with a model other than the displayed one(s).*
200 rpm is not specified in any standard for rotational viscometers. It is a custom speed "C". By tapping on the list headers, you can sort the list either by speeds (increasing/decreasing) or by "Info". In the method setting, you can add custom speeds to the list (button <More>). Users without rights to edit method settings can select custom speeds in Manual Mode on the main screen.
- **Max. Viscosity:** Maximum viscosity that is measurable with this speed and the connected spindle.

7.1.1 TruMode™ (Automatic Speed Search)

The option *TruMode™* adjusts the speed so that ViscoQC reaches a torque of approximately 80 %. Speed range: 1 rpm to 200 rpm

TruMode™ is available for measurement modes "Manual Mode (MM)" and "Stop at Time (@t)".

If using TruMode™, ViscoQC searches for the right speed until it has reached the desired torque and the values have been stable for at least 10 s.

Note: *Once the desired torque and stability have been reached with a certain speed, ViscoQC uses this measuring speed for the entire test duration. If the torque changes later during the test due to e.g. shear thinning/thickening or temperature influences, the measuring speed is not adjusted.*

If the required torque cannot be reached or the torque range is exceeded, ViscoQC displays an error and a message in the message list recommending the use of a bigger or smaller spindle. The message also tells if the viscosity range of the sample does not fit into the current setup, current spindle, or the torque range of the ViscoQC model.

7.2 Measurement Methods

TIP: *By default, only users with administrator rights can access the method settings.*

ViscoQC 300 base model comes with seven default methods: there is one preset method for each measurement mode (see section 7.3). Default methods are named after their modes. Their names start with the letters "AP" (Anton Paar). You cannot edit default methods. To customize a method, copy the default method, which best fits your requirements.

1. Tap <Menu> and select "Method Settings".
2. <More> allows you to create or delete methods, and to set their visibility. *Users cannot select invisible methods for measuring.*
3. Long press on a method in order to copy it.
4. Tap a (copied) method in order to edit it.
5. By tapping on the list headers, you can sort the methods either by name, mode or visibility.

If you create or edit a method, define the following settings. Each method has mode-specific and general settings. See table 4.

Table 4: Method settings depending on the selected measurement mode

Manual Mode (MM)	Speed Scan (SpS)	Stop @ Temp. (@T)	Stop @ Time (@t)	Stop @ Torque (@M)	Stop @ Viscosity (@V)	Time Scan (TiS)
Single point	Multi point	Single point	Single point	Single point	Single point	Multi point
Method Name (enter a method name)						
Measurement Mode (select mode, according to table header)						
Specific Method Settings						
- Speed List Items	- Set value parameter - Start Set Value - Stop Set Value - Number of Points - Distribution type - Preshear Time - Target Time	- Set value parameter - Set Value - Target Pt100 Temperature	- Set value parameter - Set Value - Target Time	- Set value parameter - Set Value - Target Torque	- Set value parameter - Set Value - Target Dyn. Viscosity	- Set value parameter - Set Value - Preshear Time - Target Time - Step Width
General Method Settings						
<ul style="list-style-type: none"> - Display Layout (select: 4 / 5 / 6 Widgets V-Curve^a: 1 Graph + 5 or 6 Widgets) - Immersion Depth for Vane spindles: Full (default) / Half – applies to V71 to V73 - Restrict use of spindles (enable/disable) - Restrict to Unique Spindle Identifier (enable/disable) - Allowed Spindles (if enabled, select from spindle list) - Use Limits (enable/disable) - Limits (if enabled, set limits => quantities and values) - Use operator instructions (enable/disable): - Operator instruction text (if enabled, enter max. 100 characters) - Density: 1.000 g/cm³ – default value, range: 0.0000 g/cm³ to 9.9999 g/cm³ 						
	Mathematical model (V-Curve ^a)					Mathematical model (V-Curve ^a)
Quick Settings						
Access to quick settings depends on the settings in the User Group Administration (section 5.1). It is possible to access the quick settings without full access rights to method settings.						
<ul style="list-style-type: none"> - Sample Name is mandatory (enable/disable) 						
<ul style="list-style-type: none"> - Show Set Value (enable/disable) - Set Value is mandatory (enable/disable) 						
<ul style="list-style-type: none"> - Density Input (enable/disable) - Density Input is mandatory (enable/disable) 						
<ul style="list-style-type: none"> - Show Immersion Depth for Vane Spindles (enable/disable) - Immersion Depth is mandatory (enable/disable) 						

^a V-Curve: Choice of mathematical model only available if software package V-Curve has been activated

7.3 Measurement Modes

ViscoQC 300 base model provides seven measurement modes:

- Manual Mode (MM)
- Speed Scan (SpS)
- Stop at Time (@t)
- Stop at Torque (@M) – "M" = Latin "momentum"
- Stop at Temperature (@T) – with Pt100 sensor only
- Stop at Viscosity (@V)
- Time Scan (TiS)

Manual Mode (MM)

Start measurement manually with <Start>. Preset a speed or shear rate value. ViscoQC measures at the set value until you tap <Stop>. There are no further mode parameters.

TIP: You can change the set value while the measurement is running: Change the set value directly from the main screen (<Parameter> button, Fig. 12).

Speed Scan (SpS)

This mode is suitable for analyzing a sample's flow behavior (Newtonian / shear thinning / shear thickening). With the optional V-Curve software package, the data can be further analyzed using e.g. mathematical regression models. Select speed or shear rate as set value. Enter a start value, a stop value, and the number of measurement points. Select linear or logarithmic distribution of points.

TIP: For a wide speed range, logarithmic distribution may give better results. (Linear distribution gives several points at low speed where usually no significant changes happen to the sample. Then in the high speed range, you do not get as many points as would be of interest).

Optionally, you can set a preshear time. Enter a *target time* to define the test duration for each point.

- Start/stop speed specification: see table 8
- Allowable number of points: 2 to 100
- Preshear time format:
minutes:seconds (mm:ss)
- Maximum preshear time: 59 minutes 59 s
- Target time format:
hours:minutes:seconds (hh:mm:ss)
- Maximum target time: 99 h

Start the test with <Start>. ViscoQC starts turning and sets the start speed. If selected, it preshears the sample. Otherwise, ViscoQC starts taking the time as soon as it has reached the start speed. When the target time has passed, ViscoQC sets the next speed and records the next point. The test stops when measurement has been completed at the stop speed.

TIP: The target time shall be long enough for stable reading. A minimum of 5 full revolutions is recommended. Rule of thumb:
for > 5 rpm at least 20 s, for < 5 rpm at least 60 s

Stop at Time (@t)

Preset a speed or shear rate value. Enter a *target time* (duration).

- Target time format:
hours:minutes:seconds (hh:mm:ss)
- Maximum target time: 99 h

Start the test with <Start>. When the instrument has reached the set value, it starts taking the time. The test stops when the target time has passed.

TIP: The target time shall be long enough for stable reading. A minimum of 5 full revolutions is recommended. Rule of thumb:
for > 5 rpm at least 20 s, for < 5 rpm at least 60 s

Stop at Torque (@M)

Preset a speed or shear rate value. Enter a *target torque*.

- Target torque format: % of maximum torque
- Torque resolution: 0.1 %
- Maximum target torque: 100 %
- Minimum target torque: 10 % (*below 10 % torque measuring values are not reliable*)

Start the test with <Start>. ViscoQC starts measuring. Within the first 5 seconds of the runtime, ViscoQC does not react if the target torque is exceeded. This eliminates false results due to transient effects. The test stops when the target torque is reached. *The only other way to end the test is to abort it by tapping <Stop>.*

"Stop at Torque" serves to check hardening or solidification processes. You expect that the sample's viscosity will increase. It is relevant to know how long it takes until a certain torque is reached.

Stop at Temperature (@T)

TIP: With optional Pt100 sensor only.

Preset a speed or shear rate value. Enter a *target temperature*.

- Target temperature format: X.X °C (unit according to Settings, section 7.5.1)
- Temperature resolution: 0.1 °C / °F / K
- Maximum target temperature: +300 °C
- Minimum target temperature: -100 °C

Start the test with <Start>. When the instrument has reached the set value, it starts taking the time. The test stops when the target temperature is reached. *The only other way to end the test is to abort it by tapping <Stop>.* The instrument shows the runtime (duration) of the test.

"Stop at Temperature" serves to observe the influence of temperature on a substance's viscosity. You require an optional Pt100 sensor.

Stop at Viscosity (@V)

Preset a speed or shear rate value. Enter a *target dynamic viscosity*.

- Target viscosity format: 0.0000, according to selected viscosity unit
- Maximum/minimum target viscosity: depends on the ViscoQC torque model and the attached spindle

Start the test with <Start>. ViscoQC starts measuring. Within the first 5 seconds of the runtime, ViscoQC does not react if the target viscosity is exceeded. This eliminates false results due to transient effects. The test stops when the target viscosity has been reached. *The only other way to end the test is to abort it by tapping <Stop>.* The instrument shows the runtime (duration) of the test.

"Stop at Viscosity" serves to observe the sample's flow behavior. You expect that the sample's viscosity will change. It is relevant to know how long it takes until a certain viscosity is reached.

Time Scan (TiS)

This mode is suitable for analyzing how viscosity changes over time. If V-Curve is activated, the data can be analyzed with the mathematical model "Thixotropic breakdown coefficient". Preset a speed or shear rate value. Optionally, you can set a preshear time. Enter a *target time* to define the total test duration.

- Preshear time format: minutes:seconds (mm:ss)
- Maximum preshear time: 59 minutes 59 s
- Target time format: hours:minutes:seconds (hh:mm:ss)
- Maximum target time: 99 h

Start the test with <Start>. ViscoQC starts turning and sets the set value. If selected, it preshears the

sample. Otherwise, ViscoQC starts taking the time as soon as it has reached the set value. ViscoQC registers measuring values for every step. The test stops when the target time has passed.

7.4 Spindles and Measuring Systems

Spindle List

TIP: *The Spindle List is available only if the Toolmaster™ (section 7.4.1.2) is disabled.*

How to select a spindle:

- Tap the spindle icon in the quick access area (p. 17). The spindle information is displayed. Tap <Spindle>.

The list contains all spindles and measuring systems, which you can use with ViscoQC. (Find an overview in appendix B).

The spindle information shows the selected spindle, its factors and which type of guard is required.

TIP: *All spindles are available independent of the ViscoQC torque range (e.g. RH-spindles can also be used with ViscoQC 100 - L). In addition to all pre-defined spindles/measuring systems you can select custom spindles (section 7.5.3).*

- **Guard type required:** Shows which spindle guard is recommended. If no guard is specified, the spindle does not require one. (See also p. 26).

The spindle guard is a metal frame. It influences the flow conditions in the sample substance. The guard is a common item with rotational viscometers of similar type as ViscoQC. For low-viscosity samples the guard's influence needs to be considered. Otherwise measuring results are not comparable to results measured with a similar viscometer, spindle, and guard. Consequently, certain ViscoQC spindles and torque ranges require a spindle guard:

- ViscoQC - L, spindles L1, L2: Guard L
- ViscoQC - R, spindles RH1, RH2: Guard R

The selected spindle is used in all methods.

7.4.1 Spindle System Settings

TIP: *By default, only users with administrator rights can access the spindle system settings.*

Spindle system settings contain all settings relevant for tracing spindles and measuring systems.

7 Measuring Settings, Methods and Modes

Select "Menu > Setup > Spindle Management > Spindle System Settings". Tap check boxes to enable/disable them.

7.4.1.1 TruGuard™ (Guard detection)

TruGuard™ is relevant for spindles as well as for DIN systems (CC, DG). See section 5.3.2 and appendix B.

- By default, TruGuard™ is enabled (green check).
ViscoQC detects whether a guard/DIN adapter is mounted and also the type of guard. If no or the wrong item is connected, you get a warning. You can ignore the warning and perform measurements. The summary shows a warning sign for the guard.
- If you disable TruGuard™ (check box empty), the instrument no longer monitors if and which guard/DIN adapter is connected.
- If you set TruGuard™ as mandatory (green check), you cannot start measuring if a wrong or no guard is connected (for spindles with recommended guard). The summary shows an error sign for the guard.

7.4.1.2 Toolmaster™

All ViscoQC spindles and measuring systems have a chip inside their magnetic coupling. This chip carries the following information:

- Spindle/system identification (name + UID)
- Spindle/system factors – *if editing the SCF (section 6.2.1), it is stored on this chip*

When a spindle/measuring system is connected, the Toolmaster™ board in the upper part of the magnetic coupling reads the data and ViscoQC uses them for measurement.

- Toolmaster™ enabled (*default*): You do not need to select a spindle or measuring system.
- Toolmaster™ disabled: You have to select spindles/measuring systems manually from the Spindlelist (section 7.4). There is no communication between ViscoQC and spindle. It is not possible to edit the spindle correction factor (section 6.2.1). Unique identifier is not available.

7.5 Instrument Setup

Setup contains all instrument settings, which are valid across all methods.

7.5.1 Set Units

ViscoQC allows to customize the displayed units for physical quantities.

1. Tap <Menu> and select "Setup > Set Units".

Table 5: Available Quantities and Units

Quantity	Units (bold print = default unit)
Temperature	– °C (degree Celsius) – °F (degree Fahrenheit) – K (Kelvin)
Dynamic viscosity	– mPa·s (milliPascal-second) – Pa·s (Pascal-second) – cP (centiPoise) – P (Poise)
Kinematic viscosity	– mm²/s (squaremillimeter per second) – cSt (centiStokes) – St (Stokes)
Torque	– µNm (microNewton-meter) – mNm (milliNewton-meter) – % (percent of full scale range) – dyn.cm (dyne-centimeter)
Shear Stress	– N/m² (Newton per squaremeter) – dyn/cm² (dyne per squarecentimeter) – Pa (Pascal)

2. Tap on a quantity.
3. Select the desired unit.
4. Tap <OK> to save the selected units.

7.5.2 Control Panel

In the Control panel define how the instrument communicates with the user. Refer to the menu tree for default access rights of user groups.

Tap <Menu> and select "Setup > Control Panel":

- Sound – enable/disable sound
If enabled, ViscoQC beeps when:
 - a measurement is finished
 - connecting a spindle
 - connecting a spindle guard or DIN adapter
 - connecting a Pt100 sensor
- Date and Time – set date and time
The format depends on the regional settings.

- **Regional Settings**
Select your language, a data format (decimal separator, date/time format) and the preferred keyboard layout.
- **Time Server Settings**
Using a time server allows you to connect your instrument to a server providing the current time of your country. Set the time zone:
 - a. Connect the instrument to your local network via Ethernet interface.
 - b. Activate the check box "Use Time Server".
 - c. Enter the addresses of the time servers that shall be used for the synchronization. Separate the addresses by a semicolon. Servers of ntp.org are used per default.
 - d. Select your time zone from the list.
 - e. Tap <OK>. The instrument reboots.
- **Printer Management**
Select an option for printout. Add or delete options. Default options:
 - PDF Export – transfer to USB storage device, PC, or LAN
 - Dymo LabelWriter 450 – see section 4.2.3.3
 - V-Collect software – see section 4.2.3.4
 You can define an option as default printer. Depending on the printer type, set details (e.g. paper format, color print, IP address).
- **Network**
Connecting the instrument to your local network, enables you to use a network printer for printouts and to retrieve the instrument's system information from any PC on the network.

TIP: Here you also find the unique MAC address of the instrument.

 - a. Connect the instrument over its Ethernet interface to your local network.
 - b. If your network server provides DHCP functionality, activate "Obtain an IP address automatically (DHCP)" and tap <OK>.
 - c. If your network server does not provide DHCP functionality, enter the correct settings manually: IP address, subnet mask, default gateway, addresses for the primary and secondary DNS server. Then tap <OK>.
- **Instrument Name and Location**
If you have more than one Anton Paar instrument, and want to differentiate between them in printouts, data exports or within your local network (LIMS), you can define instrument names and locations.

- **FTP Settings**

If data transfer to and from USB storage devices is not possible, you can alternatively export data to an FTP server. Create, edit and delete an FTP server connection:

If necessary, contact your local IT administrator for information on FTP server path (IP address), user name and password.

- a. Connect the instrument over its Ethernet interface to your local network.
- b. Tap <More> and <+ New> to specify the following settings:
 - Name of the connection: choose freely
 - FTP server path: IP address
 - Username: user name used in the FTP client
 - Password: password used in the FTP client

TIP: User name and password are case sensitive.

The name specified for the connection is now listed as an optional storage location.

7.5.3 Custom Spindles

TIP: By default, only users with administrator rights can access the custom spindles.

Custom spindles equipped with Toolmaster™ are automatically recognized by the instrument. All spindle factors are stored on the chip. It is possible to edit the SCF (section 6.2.1). If a custom spindle is without Toolmaster™, data for the custom spindle can be stored in the instrument.

Manually setting a custom spindle

1. Tap <Menu> and select "Setup > Spindle Management > Custom Spindles". Set the spindle factors SMC (Spindle Multiplier Constant), and SRC (Shear Rate Constant). If the shear rate is not defined for this spindle, SRC remains undefined. DIN systems with defined geometry have shear rate constants.
For vane spindles (for paste- or gel-like substances), enter a YMC (Yield Multiplier Constant).
2. Tap a factor. Enter your input: Menu navigation, p. 18.
3. Tap <OK> to save your input.

Default settings:

- Spindle Multiplier Constant SMC = 1.000
- Shear Rate Constant SRC = ---
- Yield Multiplier Constant YMC = ---

Allowed ranges and resolution:

8 Performing Measurement

- SMC range: 0.001 to 1500
- SMC resolution: steps of 0.001
- SRC range: 0.0000 to 500
- SRC resolution: steps of 0.0001
- YMC range: 0.1 to 500
- YMC resolution: steps of 0.01

The factors of a custom spindle without Toolmaster™ are stored inside ViscoQC. You can change them if required. *It is not possible to edit the SCF of a spindle without Toolmaster™.*

TIP: *If working with two Toolmaster™ custom spindles, ViscoQC identifies each spindle by its name plus the unique identifier (UID) of the Toolmaster™ chip. The spindle name shows in the header on the main screen together with the maximum measurable viscosity. The UID appears in the spindle information (section 5.2). If not connected, you can identify a custom spindle by an engraved number below the magnetic coupling.*

8 Performing Measurement

8.1 Preparation and Sample Filling

If available, prepare your sample according to a suitable standard test method, guide or practice.

The equipment employed for measurement must be clean and free of residues.



WARNING

Risk of injury, health risk

- Using chemically or biologically hazardous chemicals as samples or cleaning liquids is a health risk.
- Measuring hot (> 40 °C/104 °F) or very cold (< 0 °C/32 °F) substances is a health risk.

The above risks could cause serious injuries unless special precautions are taken. Consult the material safety data sheets of the sample substances and cleaning liquids. Operate the ViscoQC in a fume hood and make sure to use suitable protective equipment. Adhere to the instructions in section 1.

NOTICE

Risk of damage to instrument parts

- Make sure that all wetted parts are resistant to the sample substance and cleaning liquids (section 10.3).
- **For open vessels:** Make sure that sample temperature is between -100 °C and +100 °C (-148 °F to +212 °F).
- Make sure that the sample will not solidify or harden inside the sample vessel. Otherwise you may have to dispose of the spindle/measuring system and/or spindle guard.

8.1.1 Measuring with Spindles

1. Use a sample vessel of at least 500 mL filling volume (e.g. typical 600 mL lab beaker with approx. 83 mm inner diameter). Fill the sample into the test vessel.

A sufficient sample filling height is important, because the tip of the spindle should be at least 10 mm above the vessel's bottom and the spindle should be immersed as far as the mark on its shaft.

2. Slowly dip the spindle into the sample vessel. Incline disc spindles so that you do not trap air bubbles on the bottom side of the spindle.

If using a spindle guard, immerse that first (then the spindle).

3. Put the sample vessel beneath the measuring head. Move the ViscoQC measuring head slowly downwards until it nearly touches the spindle. Pull the spindle upwards and fix it on the measuring head. If applicable, mount the guard on the measuring flange (section 5.3).

- If applicable, place the Pt100 sensor in the sample vessel (section 4.2.3).
- Adjust the height of the measuring head: immerse the spindle until the sample level reaches the mark (small recess) on the spindle shaft. Adjust the position of the sample vessel: the spindle must be centered.

TIP: The beaker can be positioned exactly centrally to the spindle by using the flexible cup holder.

Remark: Vane spindles V71 to V73 have two immersion marks (full and half). Per default, the immersion depth is set to full and this SMC is used for calculation of viscosity. If only low sample volume is available and half immersion of V71 to V73 is needed, set the correct immersion depth in the method settings (see table 4). The recommended speed range for vane spindles is up to 10 rpm. Above 10 rpm turbulences (Eddy currents) might cause higher viscosity readings.

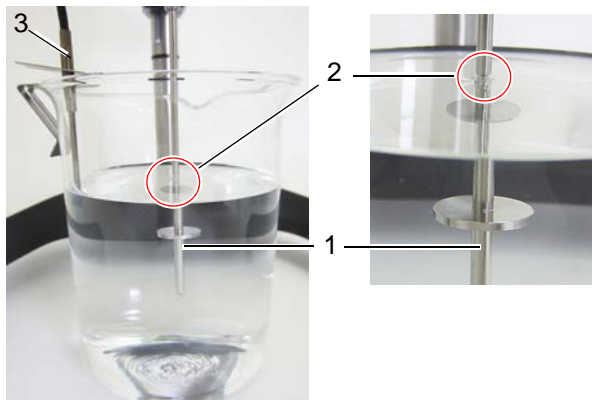

- Spindle
- Immersion mark
- Pt100 sensor

Fig. 18: Positioning a spindle in the sample vessel

8.1.2 Measuring with DIN Systems

NOTICE

Risk of erroneous measuring results

If you calibrate a CC/DG system, the calibration includes all following parts: DIN spindle (bob), cup, hook, coupling and the DIN Adapter. When exchanging any of these parts, perform a new calibration to verify the measured values!

- For DIN measuring systems, mount the DIN Adapter on the measuring head (section 5.3.2).
- Fill the sample into the provided cup up to the mark or use the recommended sample filling

volume (see table 12). Proceed slowly to avoid air bubbles.

- Dip the selected measuring bob into the sample substance.
- Insert the cup into the DIN adapter from below until it clicks. The upper rim of the cup is now level with the rim of the DIN adapter.
- Rotate the cup until the notch on its rim clicks into place (see arrow).
- Pull the measuring bob upwards and fix it on the measuring head (section 5.3). Place the optional cover on the cup (if applicable).



- DIN adapter
- Cup
- Notch on cup rim
- Cup positioning screw of DIN adapter
- Bore for optional Pt100 sensor
- Pt100 sensor (optional)

Fig. 19: Mounting a DIN measuring system

8.2 Measurement Procedure

Set the measuring parameters (section 7). Tap <Start> to start measuring. The display depends on the selected method.

When you start measuring, ViscoQC starts the motor. Until it reaches the set value (for TruMode™, this is the speed that gives the target torque) the progress bar is red and in motion and says "Preparing". The counter starts at once, but the runtime is not yet counting. Viscosity and torque values are gray until the measured torque is at least 10 % of the full scale range, then they turn black.

8 Performing Measurement

TIP: In order to get reliable measuring values, the spindle should have completed at least **five revolutions** before a value is accepted. In case you do not manually stop the test, your settings should agree with this rule (especially if the measuring speed is low).

Recommendation: > 5 rpm: 20 s / < 5 rpm: 60 s

If no Pt100 sensor is connected, the temperature reading is " --- ".

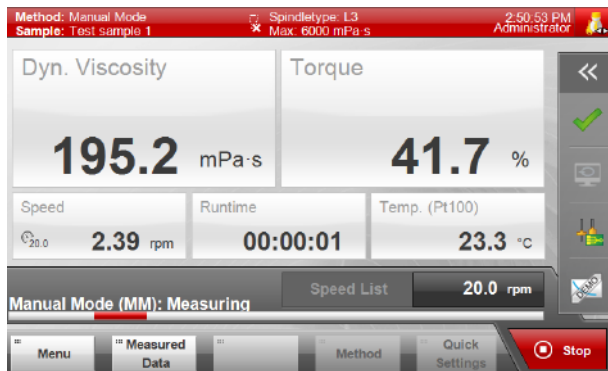



Fig. 20: Measuring – example Manual Mode

After preparation and optional preshearing: The progress bar is red and in motion. It says "Measuring". The runtime starts counting.



Fig. 21: Measurement finished – example Manual Mode

When the measurement is ready, the progress bar turns green and says "Finished". If an error or warning occurs, the progress bar is also red. The counter shows the duration of the total test procedure. The runtime shows the duration of the actual measurement. All measured values are frozen on the screen.

To unfreeze the screen tap .

If you stop a measurement before ViscoQC has finished "Preparing" or before it has reached a target value, the progress bar is red and reads "Finished". Data are neither exported to V-Collect Software nor sent to the USB printer. Target values depend on the set measurement mode.

When you are finished, remove all parts:



WARNING

Risk of injury, health risk

If you measured at very high or low temperatures, wait until the sample reaches a temperature between 15 °C and 40 °C before you handle the hot or cold parts or make sure to use suitable protective equipment. Adhere to the instructions in section 1.





1. Unscrew the spindle guard (if used) and disconnect the spindle. For DIN systems, first disconnect the measuring bob, then turn the cup to unlock it from the DIN adapter and pull the cup downwards.
2. Put the sample vessel aside and lift the parts out of the sample substance for cleaning.

TIP: Do not let the sample dry on the wetted parts. Clean all wetted parts immediately.

8.3 Measured Data

To view measured data, tap the button <Measured Data> on the main screen or select "Menu > Data Memory > Measured Data".

The multiple sample view shows a list of all measurements. In the first column of the multiple sample view, you find an icon for each measured sample. The icon indicates the status of the sample:

	Sample successfully measured
	Warning: e.g. spindle guard required but not used
	No result due to a malfunction: e.g. TruMode™ cannot reach target torque
	Measurement aborted

Tap a measurement to view details.

You can select, print/export or delete (by default only with administrator/manager rights) data. In the multiple sample view, tap <More> or perform a long press on a measurement to access these options.

NOTE: If automatic printout via V-Collect software is active, access to data memory on the touch screen is not possible.

9 Cleaning



WARNING

Risk of injury, health risk

Using chemically or biologically hazardous chemicals as cleaning liquids is a health risk. The above risks could cause serious injuries unless special precautions are taken. Clean parts in a fume hood and make sure to use suitable protective equipment. Adhere to the instructions in section 1.

The choice of the cleaning liquid(s) depends on the tested samples. All wetted parts of ViscoQC must be chemically resistant to the cleaning liquid(s). Refer to section 9.2 for an overview of concerned parts and materials. A suitable cleaning liquid must completely dissolve and remove the sample. The chemical quality must be high enough so that the cleaning liquid does not leave any residues (e.g. particles).

It has to be a good solvent for all sample components. If this first cleaning liquid does not dry up fast and/or without leaving residues, a second cleaning liquid is required.

Cleaning liquid 2 must completely dissolve and remove cleaning liquid 1. It should easily evaporate.

9.1 Standard Cleaning

Required equipment

- Cleaning liquid(s), see above
- Optional: vessels for immersing parts
- Lint-free tissue or lab paper
- Soft cleaning cloth or soft brush
- Protective equipment for user

Procedure

NOTICE

Risk of damage to instrument parts and faulty measuring results

- Do not bend or drop spindles or measuring systems, nor the spindle guard. Any damage, however small, can cause large measurement errors.
- The spindle coupling and the instrument side of the coupling must be completely clean. The coupling must not be oiled or lubricated.
- Do not use force when removing sample substances from a spindle or measuring system. Do not use abrasive substances or tools for cleaning. Those would scratch the surface of the spindle/cup.
- Do not immerse the Toolmaster™ chip on the top of a spindle coupling into liquids. Do not place the Toolmaster™ chip in an oven at 70 °C (158 °F) or higher.
- Do not immerse the Pt100 sensor deeper than the end of the sensor sleeve. The sensor cable must not be immersed.

1. Take all parts (spindle, if applicable: spindle guard and Pt100 sensor) out of the sample substance and clean them.
2. First, wipe the part with dry paper. Wet a fresh sheet of paper with cleaning liquid and wipe the part again. If the sample is hard to remove, immerse the part except for the Toolmaster™ chip in cleaning liquid. Let the part soak for some time before wiping it.
3. You can also clean the parts with a **soft** sponge or **soft** brush.
4. If necessary, clean the parts again with a second cleaning liquid.
5. Empty the sample vessel and clean it. Proceed as described above. For DIN cups, pull off the bottom (DG: unscrew the bottom and then pull) and clean the parts separately.
6. Dispose of sample substance and contaminated paper according to the regulations of your country. Consult the material safety data sheets of the sample substances and cleaning liquids.

7. If you need to clean the Toolmaster™ chip, use a soft tissue and wet it with e.g. ethanol, isopropyl alcohol or petroleum benzine. Wipe the chip.
8. If necessary, wipe housing and touch screen: Use a soft cloth dipped in ethanol or warm water (optionally plus a mild solvent, pH < 10).

9.2 Wetted Parts

Parts in contact with sample or cleaning liquid:

Table 6: Sample Wetted Parts

Material	Part
Stainless steel 1.4404/1.4435 (AISI 316L)	Spindles, spindle guard (optional), DIN system bobs
Anodized aluminum 3.2315 (6082)	DIN system cups
1.4310 (AISI 301)	DIN system spindle hook
PEEK	Sample cover
POM-C black	DIN cup bottom
NBR	O-ring of DIN cup bottom
Aluminium (Al 99.7)	Disposable cup of system CC12/D18
Stainless steel 1.4571(SS316Ti)	Pt100 sensor (optional)

10 Maintenance Work

10.1 Software Maintenance

Find all software maintenance functions in the *Service* menu. Tap <Menu> and select "*Service*":

- TruSine (Bearing check) (section 10.1.1)
- Update (section 10.1.2)
- System information: shows ViscoQC model and serial no., current software and firmware version, serial numbers of motor/sensor unit and main board, operating system and active software packages (V-Curve / V-Comply)
- Activate Software Packages (enter the token to activate the upgrade software package: V-Curve and/or V-Comply)

10.1.1 TruSine™ (Bearing check)

The *TruSine™ (Bearing check)* checks whether the measuring apparatus of ViscoQC is in good working order. It proves that sensitive parts such as the spring and the point jewel (bearing) are not damaged or worn.

Perform a new bearing check: *Menu > Service > TruSine (Bearing check)*". Remove the spindle and tap <Next>. Do not touch the instrument until the

check is finished. A successful bearing check shows a very smooth decrease of torque. The final torque value should be between 0.0 % and 0.5 % to be valid. Message: "Successful". Tap <OK>.

If the bearing check fails, calibrate with a reference standard liquid (see section 6.1).

If calibrating also fails, contact your local Anton Paar representative.

10.1.2 Software Update

NOTICE

Risk of data loss

- Before updating the software, contact your Anton Paar representative, as an update can possibly affect settings concerning data transfer and interfaces.
- To update the system, you need administrator rights (section 5.1). It is not possible to downgrade the system to an older version!

TIP: *Before updating the system, export or print relevant measurement data.*

To update the instrument, you need a USB storage device or FTP server with an update file in the root directory. The current ViscoQC 300 software/firmware package is available from Anton Paar. Download it with the following link:
www.anton-paar.com/viscoqc-webkit

Make sure to extract all files correctly.

1. Plug the USB storage device into the USB interface on the rear of ViscoQC or connect the ViscoQC 300 to the FTP server.
2. Tap <Menu> and select *Service > Update > System Update*. Select the storage location and the file name of the new software package. Follow the procedure via messages on the display.
3. When the update is finished, select your operating language and enter all customized settings (method settings, custom speeds, temp. offset...).

10.2 Adjusting the Head Retention

The head retention holds the measuring head on the rod of the stand. It defines how easily the head moves when you turn the hand wheel.

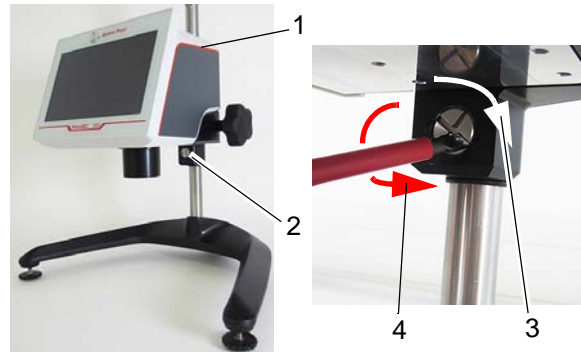

- 1 Measuring head
- 2 Head retention
- 3 Tighten the head retention
- 4 Loosen the head retention

Fig. 22: Adjusting the head retention

To adjust the head retention, insert a large slotted screw driver or small coin into one of the slits on the head retention.



CAUTION

Danger of hand injuries, squeezing

The head can drop uncontrollably if you open the head retention. Do not open or close the head retention unless the head is in the lowest position on the rod.

- To tighten the hold, turn clockwise.
- To loosen the head retention, turn counter-clockwise.

10.3 Storing and Transporting the Instrument

Clean all parts of the instrument before storing it. Clean these parts as described in section 9.1. Make sure no sample residues or spills remain on the instrument. Disconnect the instrument from the mains supply.

Screw the transport protection onto the magnetic coupling by turning it to the right.

Put all parts into the original packing box or cover the instrument with a dust protection hood.

Store the instrument in a dry, clean place.

Appendix A: Technical Data

Table 7: ViscoQC 300 torque specifications

Torque range ViscoQC 300 (10 % to 100 %)	
- L	0.00673 mNm to 0.0673 mNm
- R	0.07187 mNm to 0.7187 mNm
- H	0.57496 mNm to 5.7496 mNm
Accuracy (± 1 % of FSR ^a)	
- L	0.673 μ Nm
- R	7.187 μ Nm
- H	57.496 μ Nm
Resolution (± 0.1 % of FSR ^a)	
- L	0.0673 μ Nm
- R	0.7187 μ Nm
- H	5.7496 μ Nm

^a FSR = Full Scale Range = 100 % torque

Table 8: ViscoQC 300 speed specifications

Speed range	0.01 rpm to 250 rpm
Number of speeds	<ul style="list-style-type: none"> Speedlist with 18 standard speeds 1 fixed custom speed C0 (200 rpm) Freely selectable speeds within the speed range
Resolution	<ul style="list-style-type: none"> 0.01 rpm to 9.99 rpm: 0.01 rpm 10 rpm to 59.9 rpm: 0.1 rpm > 60 rpm: 1 rpm

Table 9: Pt100 temperature sensor specifications

Measuring range	Accuracy (non-calibrated)
+15 °C to +30 °C (+59 °F to 86 °F)	± 0.5 °C (± 1.0 °F)
-60 °C to +149 °C (-76 °F to +300 °F)	± 1.0 °C (± 2.0 °F)
+150 °C to +300 °C (+302 °F to +572 °F)	± 2.0 °C (± 4.0 °F)
Resolution	0.1 °C (0.2 °F)

Table 10: Ambient conditions

Ambient temperature	0 °C to 40 °C (32 °F to 104 °F)
Air humidity, relative	≤ 80 % up to 31 °C (88 °F), linearly decreasing down to 50 % at 40 °C (104 °F), non-condensing
Absolute altitude	maximum 4000 m
Pollution degree	2 (EN 61010)
Environment	laboratory and industry, indoor use only
Environmental standards	EN 61326 EN 61010
Airborne noise emitted	< 70 dB/A

Table 11: General specification

Dimensions WxDxH	361 mm x 281 mm x 444 mm (14.2 in x 11.1 in x 17.5 in)
Net weight	6.2 kg (13.7 lbs) <i>ViscoQC + stand</i>
Shipping weight	9.6 kg (21.2 lbs) <i>Box + supplied parts (table 1)</i>
Power supply:	
At Instrument	DC 24 V / 3 A
AC Adapter	90 VAC to 264 VAC; 47 Hz to 63 Hz
Power	70 W max.
ViscoQC housing material	
Housing	PC (Polycarbonate) + ABS (Acrylonitrile Butadiene Styrene)
Stand rod	Stainless steel 1.4301 (SS304)
Stand leg	Zamak 5 Z410 (ZnAl ₄ Cu ₁)
Interface specifications	
3x USB-A, USB-B CAN, Ethernet Pt100 sensor	

Appendix B: Spindle Overview

Find spindle factors inside ViscoQC: see Spindle information p. 17.

TIP: In order to view factors of spindles that are not actually at hand, deactivate the Toolmaster™ (section) before you open the Spindle information. Via spindle list (field "Spindle") you can then view all available spindles and measuring systems.

Table 12: ViscoQC Spindles

Spindle name	Guard required	Filling volume	
Standard spindles			
L1	L	500 mL (600 mL beaker)	
L2	L		
L3	L can be used, its influence does not significantly affect measuring results		
L4			
RH1	R (only for ViscoQC - R)		
RH2	R (only for ViscoQC - R)		
RH3	R can be used, its influence does not significantly affect measuring results		
RH4			
RH5			
RH6			
RH7			
Concentric cylinder measuring systems (according to ISO 3219) ^a			
CC12	D (DIN adapter)		2 mL
CC18	D (DIN adapter)		6.4 mL
CC26	D (DIN adapter)	18.5 mL	
Concentric cylinder measuring system with wider gap and disposable cup ^a			
CC12/D18	D (DIN adapter)	11.8 mL	
Double-gap cylinder measuring system ^a			
DG26	D (DIN adapter)	7 mL	
Vane spindles (for gel or paste like substances / for shear sensitive substances) – max. 10 rpm			
V71	no spindle guard	500 mL / 300 mL ^b (600 mL beaker)	
V72		350 mL / 250 mL ^b (400 mL beaker)	
V73		200 mL / 160 mL ^b (250 mL beaker)	
V74		20 mL (25 mL beaker)	
V75		60 mL (100 mL beaker)	
Custom spindle: Set in "Menu > Setup > Spindle Management" (section 7.5.3).			
Custom	depends on spindle		

^a Define a Spindle Correction Factor (section 6.2.1) in order to achieve measuring accuracy better $\pm 3\%$.

^b Immersion depth: Full / Half

Appendix C: Menu Tree

Tap <Menu> to access ViscoQC 300 main menu:

Administrator	Explanation: The colors show which parts of the menu are accessible for users with administrator, manager or operator rights. These are the default user groups.
Administrator, Manager	
Administrator, Manager, Operator	

Data Memory	Measured Data	View, select, print/export or delete (only administrator/manager) measured data	
	Adjustment Data	Current Adjustment Report	View, print/export the current Level/Zero Adjustment data.
		Adjustment History	View the history of Level/Zero Adjustments and their data. Select, print/export or delete (only administrator/manager) adjustment data.
Method Settings	(Current) AP Manual Mode <i>selected by default</i>	Measurement Mode: Manual Mode (MM)	Set method visibility: show methods, which can be selected for measurement (button <Method>). The current method is always visible. Sort methods (by name, mode or visibility). Copy, delete (not allowed for the current method) methods. You see default "AP" methods. You cannot edit or alter default methods! Copy a method suitable for your application and edit it. For each method: Set measurement parameters depending on the selected measurement mode
	AP Speed Scan	Measurement Mode: Speed Scan (SpS)	
	AP Stop at Temperature	Measurement Mode: Stop at Temperature	
	AP Stop at Time	Measurement Mode: Stop at Time (@t)	
	AP Stop at Torque	Measurement Mode: Stop at Torque (@M) => <i>Latin "Momentum"</i>	
	AP Stop at Viscosity	Measurement Mode: Stop at Viscosity (@V)	
	AP Time Scan	Measurement Mode: Time Scan (TiS)	
	Setup	Spindle Management	
Custom Spindle			Create, edit or delete custom spindles.
Set Units		<ul style="list-style-type: none"> - Temperature (°C °F K) - Dyn. Viscosity (mPa·s Pa·s cP P) - Kin. Viscosity (mm²/s cSt St) - Torque (µNm mNm % dyn·cm) - Shear Stress (N/m² dyn/cm² Pa) 	Set units for the listed quantities



↓ Setup ↓	Control Panel	Sound	Select when audio signal (beep) should be emitted
		Date and Time	Set instrument data and time
		Regional Settings	Select language, data format, keyboard layout
		Time Server Settings	Enable / disable use of time server; name time server and select time zone
		Printer Management	Select, edit or add printers. PDF File Printer = default
		Network	Enter IP address, subnet mask, default gateway, primary and secondary DNS
		Instrument Name and Location	Set instrument name and location. Default: None
		FTP Settings	Set name, path, user name and password for storing data to a network instead of to USB storage device
	System Security ^a	Security Level	Low or 21 CFR Part 11. View details for each setting
		Audit Trail	Enable / disable audit trail and reminder for backup file. Set remind period (in days)
		Electronic Signature	Enable / disable electronic signature. Enable / disable signature password
		Logon Settings	Enable / disable and set a value for: - Auto-Logoff: 1 to 60 min - Password expiry time: 1 to 365 days - Minimum password length: 6 to 30 characters
		Increased Security	Enable / disable increased security level. View details
		Advanced Security	Disable use of USB storage devices Service logon only with customer password
		Unlock Service	Enter an unlock code to access the instrument's service level (renouncing Anton Paar warranty) and enter a customer service password.
	User Management	User Administration	<input type="checkbox"/> Administrator: Add /edit / delete users. Change passwords. Activate user accounts and auto logon. Define E-mail settings <input type="checkbox"/> Manager: Change manager password <input type="checkbox"/> Operator: Change operator password
		User Group Administration	Overview and export of user groups and their access rights for all instrument functions. Create / customize user groups and their access rights. Delete customized user groups.
	Printout Settings	Automatic Printout	Enable / disable automatic printout and printout of subsamples. Select printer type, report design and export file name to be used.
		Select Logos	Select report logo and background from a list.
		Import Logos	Import logos from external source.
		Name and Address	Enter report heading. Max. 50 characters / field

^a Security Settings are only available with upgraded software package V-Comply!

Appendix C: Menu Tree

Adjustments	Level / Zero Adjustment	Perform a Level / Zero Adjustment.	
	Edit Spindle Correction	Enter new SCF, reset to default (1).	
	Edit Temp. Offset	Enter a temperature offset for Pt100 sensor.	
Service	TruSine (Bearing check)	Perform a bearing check (section 10.1.1).	
	Update	System Update	Perform a software update
		Install Language Pack	To update an existing language package
	System Information	View the system information, instrument type, active software packages, firmware/software versions, serial numbers of instrument, motor sensor unit and main board	
	Activate Software Packages	For upgrading existing instruments with one or both software packages (V-Curve, V-Comply). Enter the unlock code, which you received, here. <i>Note! The first 8 digits of the unlock code are the serial number of the instrument.</i>	
	Unlock Service	Enter an unlock code to access the instrument's service level (renouncing Anton Paar warranty) and enter a customer service password.	

Appendix D: Trouble shooting

Errors & Warnings which might occur during operating ViscoQC.

Number	Type	Description
01	E	Maximum torque exceeded. Use smaller spindle.
02	E	Severe firmware error during booting. Restart ViscoQC. If the error persists, contact support.
03, 04, 07, 08	E	Error in Motor-Sensor unit. Contact support!
05, 06	E	No adjustment found. Contact support!
09	W	Motor will soon turn off. Stop test!
10	E	Motor overheat. Wait for cooling down.
11	E	Restart ViscoQC! If the error persists contact support!
12	E	Toolmaster™ error: severe firmware error. Restart ViscoQC. If the error persists, contact support.
13	E	Change spindle! If error persists contact support!
14	E	SCF saving failed. Attach spindle and repeat!
15	E	Restart ViscoQC. If the error persists, contact support!
16, 17, 18, 19	E	Pt100 error. Dissonnect/rsonnect Pt100 sensor. Restart ViscoQC. If the error persists, contact support!
20	E	Unknown guard. Clean guard screw!
21	E	Guard short circuit. Clean guard screw!
22	E	Retry Level Adjust. Contact support!
23	W	Not leveled.
24 / 25	W / E	For spindle [YZ] {X} Guard/DIN adapter/No Guard is recommended.
26 / 27	E / W	Perform Level and Zero Adjust.
28	W	Torque too high for TruMode AM. Use smaller spindle.
29	W	Torque too low for TruMode AM. Use bigger spindle.
30	E	Pt100 is required for @T. Please attach.
31	E	Attach a spindle or choose from list.
32	W	Measurement with ViscoQC aborted by user.
99	E	Power off during measurement. Check the mains supply. Switch ViscoQC on again. If the screen stays dark, contact support.

E: Error / W: Warning

EU Declaration of Conformity

(original)



The Manufacturer **Anton Paar GmbH**, Anton-Paar-Str. 20, A-8054 Graz, Austria – Europe hereby declares that the product listed below

Product designation: **ViscoQC™ 300**
Model: **ViscoQC™ 300 – L**
ViscoQC™ 300 – R
ViscoQC™ 300 – H
Material number: 105023, 105024, 105025

is in conformity with the relevant European Union harmonisation legislation. This declaration of conformity is issued under the sole responsibility of the manufacturer.

Electromagnetic Compatibility (2014/30/EU, OJ L 96/79 of 29.3.2014)

Applied standards:

- EN 61326-1:2013 Electrical equipment for measurement, control and laboratory use - EMC requirements - Part 1: General requirements

The product is classified as a class B equipment and is intended for the use in industrial area.

Low Voltage Directive (2014/35/EU, OJ L 96/357 of 29.3.2014)

Applied standards:

- EN 61010-1:2010 Safety requirements for electrical equipment for measurement, control and laboratory use - Part 1: General requirements

RoHS Directive (2011/65/EU, OJ L 174/88 of 1.7.2011)

Place and date of issue: Graz, 2018-10-16



DI Günter Hofer
Executive Director
Business Unit Measurement

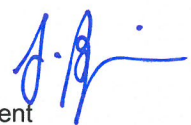

MSc Fatemeh Rezaei
Head of Viscosimetry
Business Unit Measurement