

RESULTATLISTE

1988

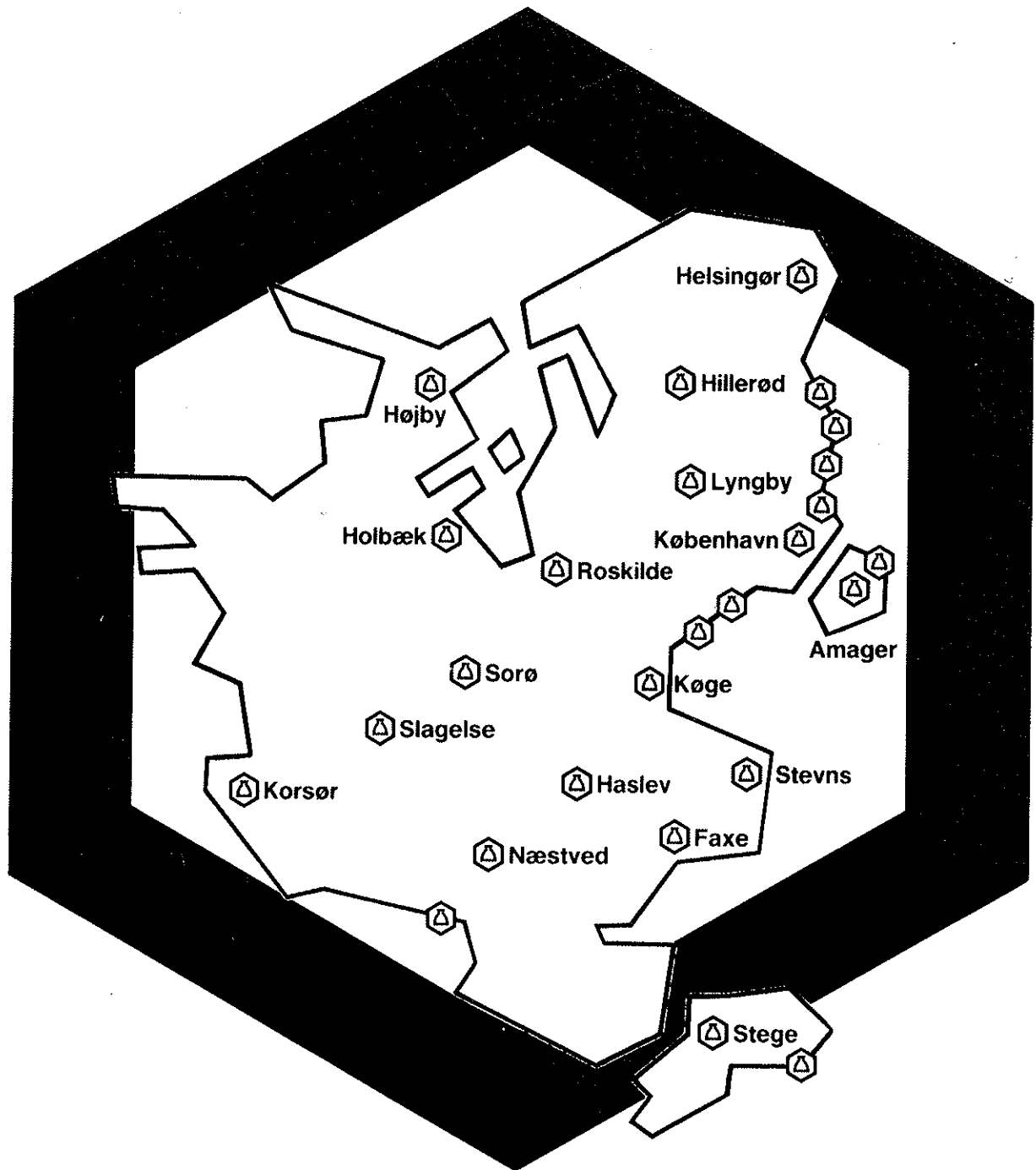



SJÆLLAND RUNDT

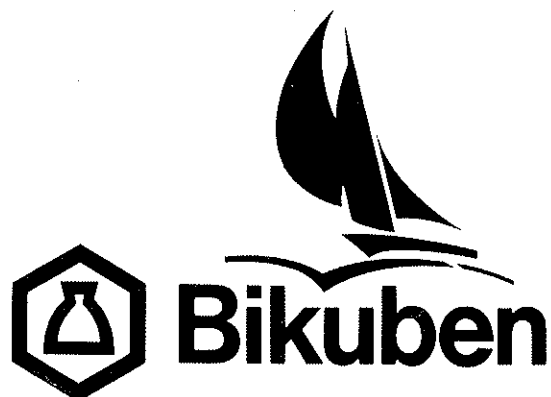

Kære Sjælland Rundt sejlere

Sjælland Rundt 1988 var på mange måder en rigtig Sjælland Rundt med vind og sol og herligt vejr. Vi siger tak til alle for jeres deltagelse.

1781 både var tilmeldt sejladsen. 133 både kom ikke til start og 80 udgik af sejladsen. 1510 både kom i mål.

I år havde vi det største antal protester nogen sinde (over 100).

Igen må vi konstatere, at mange både ikke er i korrekt målekondition (manglende sejlstempler, for lange spilerstager, manglende mærker på bom og mast). I bør drøfte dette i jeres klub og få styr på denne del af jeres deltagelse i en kapsejlad.

På det sikkerhedsmæssige område er vi glade og meget tilfredse. 350 både blev kontrolleret og der blev ikke konstateret brud på reglerne.

Bestyrelsen i Helsingør Amatør Sejlklub har på sit bestyrelsesmøde den 28.6.1988 drøftet afviklingen af dette års Sjælland Rundt og udtaler i den anledning følgende:

"Bestyrelsen i Helsingør Amatør Sejlklub har fulgt Sjælland Rundt 1988 og føler at arrangementet er inde i en uheldig udvikling med den meget omtale af ganske få store både på bekostning af de store felter. Denne udvikling vil Helsingør Amatør Sejlklub søge at stoppe og har derfor besluttet, at kapsejladsen fortsat skal være for den brede skare af danske og udenlandske sejlere og at misbrug af sejladsen i reklameøjemed forhindres. Sjælland Rundt udvalget i Helsingør Amatør Sejlklub bemyndiges til at træffe de nødvendige foranstaltninger til at sikre dette ved de kommende arrangementer."

Præmier

Der vil ikke blive afholdt nogen officiel præmieuddeling.

Løbspræmier og manglende fuldførepræmier vil blive tilsendt i slutningen af august og i september måned.

Løbspræmier vil kunne afhentes ved udfyldelse af skema (se midtersiderne).

Startpræmier (DANA 1100 Log) til hurtigste båd efter IOR og DH88 blev vundet af

Delt.nr.	Start	Løb	Bådnavn	Bådtype	Skipper	Sejltid	Pointtid
64	(IOR) 1	5	ABV	ONE-OFF	OLA SCHWARZ	37:59:38	23:22:49
976	(DH) 1	7	DAUGÅRDS-CORTINA	ONE-OFF	J.SKOVENBORG/T.JENSEN	36:39:46	42:38:24
261	2	17	OFFSET	VAL 35	JÜRGEN WASCHEK	36:10:42	37:30:23
294	3	21	POSEIDON	DRA.38	KAJ HANSEN	35:52:29	39:18:21
453	4	29	BONBON	BB.10M	HANS TOBIASEN	38:26:50	40:57:19
661	5	47	BEDSTE	BRØK.30	HENRIK BRØKER	39:46:10	41:55:36
852	6	53		X-79	HANS ERIK ANDERSEN	38:44:24	41:00:01
973	7	62	SECOND WIFE	LARS.25	BO SELKO	39:30:46	41:48:22
1083	8	69	Q	ELV.1/2	BENGT EDMAN	43:11:33	48:47:01
1308	9	80	MARGARET	8.M.R.	FINN CARLSEN	39:49:55	48:59:38
1440	10	89	PAMULA	NIMB30	HELMER BERING	43:46:42	49:17:57
1580	11	96	VAKSINE	IMP.24	BENT KIRKETERP	44:00:07	49:48:29
1687	12	104	FRU MADSEN	N.SNEK	OLE SCHMODT	44:28:45	51:29:10

Lodtrækning

1 AP-Navigator V udsat af AP-Radiotelefoner blev ved lodtrækning vundet af delt.nr.251, Göte Berg.

5 bilalarmer udsat af ISS Securitas blev ved lodtrækning vundet af delt.nr. 61, Lars Thornfeldt, delt.nr. 101, Torbjørn Ormland, delt.nr. 316, Jens Espersen, delt.nr. 1197, Nina Schiøtte, delt.nr. 1426, Ib Jørgensen.

1 Nokia-Mobira bærbar telefon "City-Man" udsat af Nokia Data blev ved lodtrækning vundet af delt.nr. 1344, Frank Lemb.

Mandskabsglas kan bestilles ved udfyldelse af bestillingsseddel (se midtersiderne).

Sjælland Rundt 1989 afholdes fra den 23. juni 1989.

Med venlig sejlerhilsen og fortsat god sæson.

Sjælland Rundt Udvalget

Sekretariatet: man-tirs 11.00-14.00 & ons-tors 14.00-18.00
Helsingør Amatør Sejlklub
Nordhavnen
3000 Helsingør
Tlf. 02- 218374

RESULTATLISTE SJÆLLAND RUNDT 1988

1. START FREDAG 10:30 BANE 1 - GENNEM GRØNSUND

236 SØMIL

LØB 5 IOR KLASSE 5, 6, 7, OG 8 (16.00 - 22.99 FEET)

NR. BÅDNAVN	TYPE	SEJLNR	BÅDENS FØRER	MÅL	ODDEN	AGERSØ	SKANSE	SALTH.	HELSINGØR	SEJLTID	POINTTTID	PLAC
64 ABV	ONE-OFF	9155	OLA SCHWARZ	21.97	F20:16	L05:15	L10:32	L19:40	S00:29:38	37:59:38	23:22:49	PR 1
58 JOINT VENTURE	BAN.1/2 D	1198	PER SLENGERIK	22.01	F20:13		L10:51	L20:40	S01:31:51	39:01:51	24:26:51	PR 2
67 FIGHT	WASA 31 S	9901	ROLF ANDERSSON	22.01	F20:28		L11:15	L21:12	S01:59:40	39:29:40	24:54:40	3
62 NN	MG 26 D	7307	ERIK G. BJERRE	18.54	F22:00		L13:21	S00:15	S05:29:43	42:59:43	25:26:17	4
63 INSERT	ONE-OFF S	6854	HANS TRÄDGÄRDH	22.02	F21:13	L06:24	L12:00	L22:12	S02:42:06	40:12:06	25:37:35	5
65 RÖDE ORM	RUSH G	2977	DIETER CHRISTIANSEN	21.29	F21:18	L06:56	L12:45	L23:03	S03:50:51	41:20:51	26:12:27	6
61 RATTLER	MG 26 D	7373	LARS THORNFELDT SØRENSEN	18.60	F22:04		L14:09	S00:35	S06:24:16	43:54:16	26:24:20	7
57 JO ANN	BAN.1/2 D	1190	FLEMMING RELSTER	22.00	F20:21	L05:35	L10:58	L21:01	S01:55:36	39:25:36	26:50:10+2	8
60 MONST.GOBBL. II	MG 26 D	7309	PIERRE NIELSEN	18.32	F22:19	L08:17	L14:30		S07:50:55	45:20:55	27:34:30	9
59 FLYING APPLE	MANZ1/4 D	1052	JØRGEN HØJERSLEV	18.28	F22:10	L08:10	L14:18	S01:00	S06:57:34	44:27:34	28:38:47+2	10

LØB 6 LUFFE 44

NR. BÅDNAVN	TYPE	SEJLNR	BÅDENS FØRER	MÅL	ODDEN	AGERSØ	SKANSE	SALTH.	HELSINGØR	SEJLTID	POINTTTID	PLAC
75 TRIP	LUFFE44 D	26	J. PESCHKE-KØEDT	9.25	F19:04	L03:32	L08:05		L22:01:07	35:31:07	44:10:11	PR 1
68 JOSEPHENE	LUFFE44 D	1	WILLY HANSEN	9.85	F19:08		L08:08		L21:46:05	35:16:05	44:53:36	PR 2
71 CHARLIE FARLEY	LUFFE44 D	17	HAMACHER/BANK	9.70	F20:20	L04:25	L09:05	F17:25	L22:19:37	35:49:37	45:13:01	3
74 FLAMINGO	LUFFE44 D	25	PREBEN SCHRØDER	9.60		L04:00	L08:45	L17:00	L22:30:03	36:00:03	45:13:54	4
73 KA-SO-SI	LUFFE44 G	23	JÖRG WILHELM	9.45			L09:39	L18:03	L22:57:41	36:27:41	45:26:51	5
72 LUFFEN	LUFFE44 D	18	OLE SKOU	9.35		L04:26	L09:25	L18:28	L23:29:55	36:59:55	45:49:08	6
70 LADY BLUE	LUFFE44 D	9	OLE LADING	9.45	F20:24	L04:29	L09:07	F17:22	L22:27:35	35:57:35	46:56:45+2	7
77 BLACK-JACK	LUFFE44 D	41	PETERSEN / BARTHOLDY	9.80	F20:00	L04:00	L08:37		L22:34:25	36:04:25	47:37:18+2	8
76 NØRKLE	LUFFE44 D	35	JAN KLEE	9.10	F19:54				UDGÅET			
69 MISS FLINK	LUFFE44 D	3	JARL FLINK	9.85					IKKE STARTET			

LØB 7 DH 8.45 - 15.30

NR. BÅDNAVN	TYPE	SEJLNR	BÅDENS FØRER	MÅL	ODDEN	AGERSØ	SKANSE	SALTH.	HELSINGØR	SEJLTID	POINTTTID	PLAC
976 DAUGÅRDS CORTIN	ONE-OFF D	1	J. SKOVENBORG/TAGE JENSEN	7.85			L09:26	L18:14	L23:09:46	36:39:46	42:38:24	PR 1
91 SØSTER	FRØK.34 D	2	LARS ISAGER HEDEGAARD	8.50	F19:29	L03:53	L08:37		L22:18:27	35:48:27	43:06:18	PR 2
90 RASMINE	FRØK.34 D	1	SØREN ANDERSEN	8.45		L04:00	L08:48		L22:37:46	36:07:46	43:19:50	PR 3
82 STEPS AHEAD	BAN. 41 N	7444	TØRE GLENBERG	9.60	F18:50		L07:50	L15:39	L21:28:55	34:58:55	44:12:46	PR 4
87 NINKA JUBILEE	DYNA.43 D	48	LAU AABLING	9.70	F19:02		L08:08	L16:20	L21:21:27	34:51:27	44:14:51	PR 5
99 MARIUS HANSEN	MH.10.5 D	1	JAN PEDERSEN	9.20	F19:19	L03:55	L08:45		L22:21:25	35:51:25	44:25:23	PR 6
83 TOLVEREN	BB 12M D	1	ANDERS BØRRESEN	9.45	F19:36	L03:51	L08:25		L21:58:17	35:28:17	44:27:27	7
79 DAN-SAILS	BAN. 41 D	1	JAN HANSEN	9.45	F19:34		L08:24		L22:00:36	35:30:36	44:29:46	8
977 KRACER	ONE-OFF S	1	LASSE HANSÉN	7.75		L05:47	L10:12	L20:36	S01:29:39	38:59:39	44:45:13	9
80 BANNE MEJ	BAN. 41 S	5	HOLM/ MEIJER	9.55	F19:04		L08:10		L22:15:03	35:45:03	44:54:01	10
96 JADE	LUFFE40 D	1	KIM WOGELIUS	9.05	F20:43	L04:54	L09:45	L18:25	L23:07:49	36:37:49	44:56:12	11
100 ESTRENO	MOL.12M D	1	THOMAS RASMUSSEN	9.65	F19:15	L03:50	L08:31		L22:20:35	35:50:35	45:09:14	12
94 KRACKEMUT	KRACE40 S	9139	LARS-ÅKE ANDERSSON	9.95	F19:22		L08:27	L16:25	L21:54:33	35:24:33	45:11:19	13
85 5-MAN	DYNA.43 S	33	OLOF MEIBY	9.70	F19:46	L04:10	L08:55		L22:28:23	35:58:23	45:21:47	14
93 HI FI	HELM47 D	4	PREBEN JACOBSEN	9.70	F19:44	L04:10	L08:51	F17:17	L22:33:20	36:03:20	45:26:44	15
97 WAVE RUNNER	LUFFE48	28343	LON PRICE	10.50	F19:22		L08:24	L16:20	L21:31:12	35:01:12	45:36:33	16
81 MARKETINGGUTTER	BAN. 41 D	6	POVL ERIK GEDDE	9.50	F21:05	L05:14	L10:11	L18:26	L23:14:52	36:44:52	45:48:57	17
101 REGNBUEEN	RAIN.42 N	7467	TORBJØRN OMLAND	12.00	F19:05	L03:05	L07:22	L14:57	L19:55:01	33:45:01	45:56:00	18
98 MATHIS DELTA	MATH.D. D	84	CHRISTIAN FISCHER	12.50	F19:11		L07:25	L14:51	L19:59:39	33:29:39	46:34:39	19
95 SUPERMAX	L 50 D	1232	TORBENSEN/ HAUGAARD/OLSEN	11.45	F21:21	L04:21	L08:48		L21:14:33	34:44:33	46:35:41	20
92 BALTICA	FUSI.62 D	62	HENNING SKOV	14.35	F18:28	L02:03	L05:47	L13:38	L18:23:16	31:53:16	46:48:53	21
89 STARMAKER	DYNA.43 G	3580	CHRISTIAN PREISSNER	9.45		L04:00	L08:37	L16:35	L22:36:57	36:06:57	47:06:07+2	22
84 VITESSE	DUB. 52	1986	TEAM-VITESSE	15.30	F18:17		L05:19	L13:19	L18:08:18	31:38:18	47:23:02	23
88 SIBONGA	DYNA.43 D	51	KNUD NISSEN	9.70	F18:54		L07:45	L15:36	DISKVALIFICERET			
78 CONCORDIA	A S 38 D	3586	NIELS SPRINGER	10.65			L07:36	L14:53	DISKVALIFICERET			
86 K.G.B.	DYNA.43 D	44	KARL GEORG BRAMMING	9.25		L03:52	L08:33	L16:35	DISKVALIFICERET			

LØB 8 DYNAMIC 4000

NR. BÅDNAVN	TYPE	SEJLNR	BÅDENS FØRER	MÅL	ODDEN	AGERSØ	SKANSE	SALTH.	HELSINGØR	SEJLTID	POINTTTID	PLAC
104 HILLS P. DIET	DYN4000 D	4001	PEER KRUISE	9.35	F18:59		L07:51	L15:47	L21:31:39	35:01:39	43:50:52	PR 1
105 STIFTEN 3	DYN4000 D	4002	POUL R. HØJ/HENRIK REESE	9.45	F20:27	L04:21	L09:01	F17:05	L22:19:42	35:49:42	44:48:52	PR 2
108 COS	DYN4000 D	4010	SVEND ERIK LARSEN	9.45	F19:54	L04:10	L08:51	F17:14	L22:24:55	35:54:55	44:54:05	3
109 LILLE SKAT	DYN4000 D	4011	ANKER HANSEN	9.50	F19:52	L04:00	L08:42	L17:00	L22:22:45	35:52:45	44:56:50	4
103 IP SOFTVEJR	DYN4000 D	15	IBEN PETERSEN	9.60	F20:21	L03:51	L08:29	L16:35	L22:14:22	35:44:22	44:58:13	5
102 KANTAPPER	DYN4000 G	4009	WILHELM ROTERMUND	9.25	F19:48	L04:00	L08:41	L16:55	L22:28:11	35:58:11	46:37:15+2	6
106 FLYING DANE	DYN4000 D	4006	POUL HEIBERG	9.35	F19:46	L03:55	L08:38	L16:55	L22:31:11	36:01:11	46:50:24+2	7
107 KEY LITE	DYN4000 D	4007	SCHLOSSER/LAUSTSEN	9.55					IKKE STARTET			

RESULTATLISTE SJÆLLAND RUNDT 1988

1. START FREDAG 10:30 BANE 1 - GENNEM GRØNSUND

236 SØMIL

LØB 9 DH 7.00 - 10.85

NR.	BÅDNAVN	TYPE	SEJLNR	BÅDENS FØRER	MÅL	ODDEN	AGERSØ	SKANSE	SALTH.	HELSINGØR	SEJLTID	POINTTID	PLAC
21	NAUTILA	ONE-OFF G	203	WOLFGANG GRESCH	8.05		L05:07	L10:11		L23:38:57	37:08:57	43:32:55	PR 1
112	BAMSEN	H.R. 49	38	CHRISTOPH RASSY	8.45	F20:09	L04:37	L09:39	L18:19	L23:15:41	36:45:41	43:57:45	PR 2
120	GRY II	WASA55 D	1	PETER SCHOUSBOE	9.65	F20:12	L04:24	L09:03	F17:52	L22:57:21	36:27:21	45:46:00	PR 3
119	JONATHAN	ONE-OFF D	169	PAUL BAYER KNUDSEN	9.45	F19:54		L10:15	L18:28	L23:17:43	36:47:43	45:46:53	PR 4
126	THYRA	YAWL D	102	P. V. CHRISTIANSEN	9.60	F20:53	L04:57	L09:54	L18:07	L23:20:53	36:50:53	46:04:44	PR 5
110	ELMARGRET	12 M CR D	999	SVEND FRIIS-HANSEN	8.55	F20:43	L05:45	L11:20	L20:38	S01:36:13	39:06:13	46:29:49	6
118	PSYKE	O C 40 D	40	MIKAEL KROHN JENSEN	7.00		L08:05	L13:47		S05:13:58	42:43:58	46:43:28	7
114	MULLIGAN	HELM.Q. G	3123	WOLFGANG MERKEL	10.85	F19:33	L03:55	L08:42	L16:45	L22:25:14	35:55:14	46:59:36	8
123	ROSA	YAWL D	1	LARS LUNDQVIST	7.35	F21:22		L14:44	S00:08	S04:40:26	42:10:26	47:01:22	9
116	ALOTOLA	KUTTER		NILS HOLCH	8.30		L07:48	L13:30	L22:50	S02:59:39	40:29:39	47:24:06	10
111	COSLE	EK 40"		JOHN POULSEN	8.75	F22:00	L06:46	L12:05	L21:57	S02:23:24	39:53:24	47:39:27	11
115	THANOS II	KULIK44 D	3329	STEFAN KRAEMER	8.20			L13:57		S03:41:09	41:11:09	47:53:34	12
125	SVANEN	YAWL D	101	M. T. FLAGSTAD	9.60	F22:13	L06:49	L12:00	L20:33	S01:11:20	38:41:20	47:55:11	13
1313	ROSELINA	KETC30 D	1867	PALLE HEMDORFF	8.75		L08:12		L22:55	S02:41:16	40:11:16	47:57:19	14
124	BARATARIA	YAWL A	77	PER SVENDSEN	8.05	L23:23	L08:37	L14:20	L23:47	S04:08:07	41:38:07	48:02:05	15
117	COSMO II	NORTH47 D	26	KIRSTIN HOFF	8.65		L08:10			S04:10:57	41:40:57	49:15:52	16
1312	STORMDIS	KETC30 D	2	PETER RIIS	7.70	L23:48		L15:31		S06:13:03	43:43:03	49:22:01	17
113	ROSA	HAVK30		PETER A. ANDERSEN	9.50		L16:55	L22:50	S15:00	S22:38:36	60:08:36	69:12:41	18
122	MANANA	YAWL		JACOB GROSSELL	5.65		L21:00			M10:10:52	71:40:52	71:40:52	19
121	SORRY	WASA55 D	49	LARS NOLKRANTZ	8.85	F20:05	L04:21	L09:16	F17:56	DISKVALIFICERET			
1311	PODLASIE	KETC30		JØRGEN KROGH JOHANSEN	10.00	L02:10	L12:25	L17:21		DISKVALIFICERET			

LØB 10 SÆRLIGT LØB UDEN PRÆMIE

NR.	BÅDNAVN	TYPE	SEJLNR	BÅDENS FØRER	MÅL	ODDEN	AGERSØ	SKANSE	SALTH.	HELSINGØR	SEJLTID	POINTTID	PLAC
127	HEARTS OF HALC. FREEDOM			LANCE REYNOLDS	L04:10	L15:50	L21:09			S18:54:58	56:24:58		

Velkommen i havn

- Vi kan også passe på din bil, når du ikke sejler Sjælland Rundt

Få gratis brochure og klar besked om effektiv tyverisikring af din bil

Udfyld kuponen og post den i dag, så sender vi dig omgående brochuren "Sådan sikrer du din bil mod tyveri". Det er ganske uforpligtende og her kan du læse om, hvordan du billigt og effektivt sikrer din bil mod tyveri og indbrud.

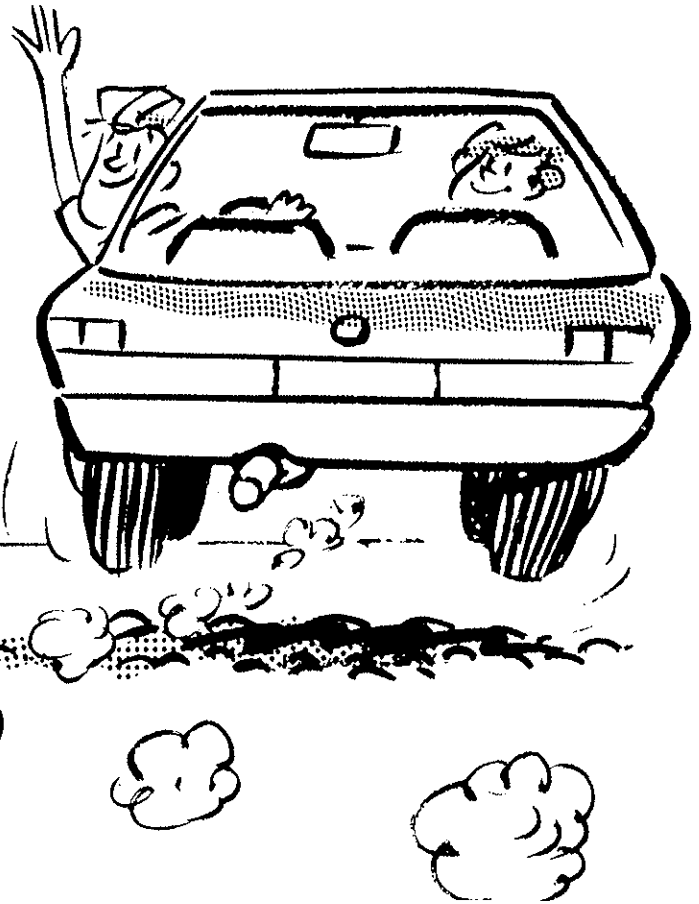

SCANAD-KØBENHAVN

- JA TAK send mig straks den gratis brochure "Sådan sikrer du din bil mod tyveri"
- Jeg ønsker opringning vedr. effektiv tyverisikring af min bil.

Tlf. nr. _____

Træffes bedst kl. _____

Navn: _____

Adresse: _____

Postnr.: _____ By: _____

Tryksag
Ufrankeret
svarforsendelse

37
Sendes
ufrankeret
Modtageren
betaler porto

Securitas

Roskildevej 157
2620 Albertslund

Securitas
- passer på Danmark

RESULTATLISTE SJÆLLAND RUNDT 1988

2. START FREDAG 11:00 BANE 1 - GENNEM GRØNSUND

236 SØMIL

LØB 12 PHANTOM 42

NR.	BÅDNAVN	TYPE	SEJLNR	BÅDENS FØRER	MÅL	ODDEN	AGERSØ	SKANSE	SALTH.	HELSEINGØR	SEJLTID	POINTTID	PLAC
139	SKULK	PHAN.44 D	1153	KAI NIELSEN	8.90	F20:02	L04:26	L09:15	F17:55	L22:56:57	35:56:57	39:01:20	PR 1
128	AMOUREUSE	PHAN.42 D	2	ERLING JENSEN	9.00	F20:05		L09:11	F17:57	L23:04:28	36:04:28	39:19:33	PR 2
138	FREJA	PHAN.42 D	1159	TONNY ANTONSEN	8.90	F20:35	L04:58	L09:56		L23:24:10	36:24:10	39:28:33	PR 3
135	VALKYRIE	PHAN.42 D	30	OLE BÆKMARK	8.75	F20:53	L05:17	L10:26		L23:42:45	36:42:45	39:30:46	4
133	DULCINEA	PHAN.42 D	26	BENT WAHL	8.75	F20:27		L10:26	L18:56	S00:13:42	37:13:42	40:01:43	5
136	SPUNK II	PHAN.42 D	31	BENT ANTHONY	8.75	F21:31		L10:59	L19:59	S00:51:07	37:51:07	40:39:08	6
137	LIGHT BREEZE	PHAN.42 D	37	TORBEN KJÆR	8.65	F21:37	L06:18	L11:25	L21:02	S01:30:56	38:30:56	41:07:50	7
134	SHAMU	PHAN.42 D	28	H. STRØYER CHRISTOPHERSEN	8.70		L07:48	L13:17	L22:44	S02:57:33	39:57:33	42:40:02	8
131	TROJKA III	PHAN.42 D	20	OLE MOGENS HANSEN	8.80		L07:54	L13:10	L22:44	S02:51:35	39:51:35	42:45:07	9
129	FRIEND-SHIP	PHAN.42 D	11	FRANK BADENFORDT	8.60	F22:33	L07:48	L13:17	L23:06	DISKVALIFICERET			
130	PENELOPE II	PHAN.42 D	17	JAN GRUE	8.00					IKKE STARTET			
132	MALOU	PHAN.42 D	22	CHRISTIAN FRØMMING	8.80					IKKE STARTET			

LØB 13 DIVA 39

NR.	BÅDNAVN	TYPE	SEJLNR	BÅDENS FØRER	MÅL	ODDEN	AGERSØ	SKANSE	SALTH.	HELSEINGØR	SEJLTID	POINTTID	PLAC
145	HAJA DI	DIVA 39 D	113	ARNOLD S OLSEN	8.55		L05:50	L10:53	L19:22	S00:01:06	37:01:06	39:26:40	PR 1
149	PRIMADONNA	DIVA 39 D	138	LISS SCHMIDT	8.50	F22:22		L10:02	L19:42	S00:13:22	37:13:22	39:33:11	PR 2
144	CON DIOS	DIVA 39 D	99	LUND POULSEN	8.55			L21:18	S01:43:30	38:43:30	41:09:04		3
140	SEE YOU LATER	DIVA 39 D	51	MOGENS KRAGELUND	8.65	F22:25	L06:49	L11:55	L21:02	S01:32:28	38:32:28	41:09:22	4
141	SEA LOVER II	DIVA 39 D	58	PER FLEMMING OLSEN	8.50	F21:37	L06:37	L11:55	L21:28	S01:57:30	38:57:30	41:17:19	5
148	NAUSICA 5	DIVA 39 D	135	PETER SIMONSEN	8.70			L10:59	L20:36	S01:35:56	38:35:56	41:18:25	6
146	CATCH ME	DIVA 39 D	114	SØREN EGGERIKSEN	8.50	F22:07	L07:06	L12:22	L22:06	S02:10:27	39:10:27	41:30:16	7
142	MADONNA	DIVA 39 D	60	B. AAGESEN/ P. WEITEMEYER	8.55		L06:56	L12:11	L21:47	S02:16:11	39:16:11	41:41:45	8
147	ANNA	DIVA 39 S	121	HANS TURÉN	8.55					UDGÅET			
143	JOYBIRD II	DIVA 39 D	61	BERTIL SVENSSON	8.70			L10:27	L19:20	DISKVALIFICERET			

LØB 14 X-99 (STANDARD)

NR.	BÅDNAVN	TYPE	SEJLNR	BÅDENS FØRER	MÅL	ODDEN	AGERSØ	SKANSE	SALTH.	HELSEINGØR	SEJLTID	POINTTID	PLAC
159	BLUE EAGLE	X-99 D	32	CHRISTEN BO JUSTESEN	8.20	F20:05	L04:39	L09:34	L18:20	L23:16:48	36:16:48	38:01:11	PR 1
161	LOIUSE	X-99 D	42	CARSTEN OLESEN	8.20		L04:55	L09:56	L18:32	L23:19:14	36:19:14	38:03:37	PR 2
188	KUNTA KINTE JR.	X-99 S	195	JØRGEN OHLSSON	8.20	F20:25	L04:53	L09:55	L18:28	L23:19:42	36:19:42	38:04:05	PR 3
153	GREY GADGET	X-99 D	17	TORBEN SKOV	8.20		L04:53	L09:55	L18:28	L23:21:22	36:21:22	38:05:45	PR 4
155	RATATA	X-99 D	23	HENRIK ANDERSEN	8.20	F20:20		L09:55	L18:28	L23:21:42	36:21:42	38:06:05	PR 5
184	KRYSS	X-99 D	153	RALPH ROLFSON	8.20			L09:55	L18:38	L23:26:37	36:26:37	38:11:00	PR 6
174	LIBERO	X-99 D	98	FRANK NØRGAARD	8.20			L10:05	L18:40	L23:29:20	36:29:20	38:13:43	PR 7
187	DIZZY MISS LIZZ	X-99 S	194	LENNART K. ANDERSSON	8.20	F20:25		L10:11	L18:45	L23:36:36	36:36:36	38:20:59	PR 8
186	DANAMAX	X-99 D	168	M BJERRE-PETERSEN	8.20	F20:42	L05:10	L10:12	L18:42	L23:39:27	36:39:27	38:23:50	9
183	X-ACT	X-99 S	129	ARNE LINDWALL	8.20		L04:54	L10:01	L18:41	L23:41:27	36:41:27	38:25:50	10
172	SUNSHINE IV	X-99 D	95	ALLAN KOCH	8.20	F20:38		L10:12	L18:46	L23:44:30	36:44:30	38:28:53	11
182	GREEN APPLE	X-99 D	125	JAN EPPERS	8.20			L10:15	L18:50	L23:47:10	36:47:10	38:31:33	12
158	CHRISTIANE	X-99 D	31	DAN N. CHRISTENSEN	8.20			L10:19	L19:00	L23:54:34	36:54:34	38:38:57	13
156	LABAN II	X-99 D	24	HANS DANRY	8.20	F20:02	L05:22	L10:27	L19:15	L23:57:59	36:57:59	38:42:22	14
163	ANNE	X-99 D	49	LARS FUNCK JENSEN	8.20	F20:28		L10:15	L19:11	S00:00:02	37:00:02	38:44:25	15
151	ALEXIS	X-99 D	9	L RYGAARD	8.20	F21:00	L05:26	L10:28	L19:22	S00:09:09	37:09:09	38:53:32	16
168	L'AMIE	X-99 D	62	J.TOFTEGÅRD NIELSEN	8.20			L10:37	L19:27	S00:09:49	37:09:49	38:54:12	17
171	KIXEN	X-99 D	92	HANS JØRGEN SCHMIDT	8.20	F21:00		L10:46	L19:38	S00:24:13	37:24:13	39:08:36	18
178	JUMPING BUTTERB	X-99 D	108	HANS OLLING	8.20	F20:00	L05:31	L10:42	L19:37	S00:27:31	37:27:31	39:11:54	19
175	NAUK	X-99 D	102	FLEMMING SEJR HANSEN	8.20	F21:00	L05:02	L10:37	L19:32	S00:36:46	37:36:46	39:21:09	20
164	TRITON	X-99 D	53	PETER JOHANSEN	8.20	F21:06	L05:41	L10:51	L20:02	S00:50:21	37:50:21	39:34:44	21
160	AGNES	X-99 D	41	JAN ANDERSEN	8.20	F19:24		L10:59	L20:05	S00:53:24	37:53:24	39:37:47	22
177	DRØMMEPIGEN	X-99 D	104	LARS GRØNLUND	8.20			L10:04	L20:18	S01:08:51	38:08:51	39:53:14	23
180	X-PEDIT	X-99 D	116	BENT OLSEN	8.20	F21:19		L10:48	L20:45	S01:23:06	38:23:06	40:07:29	24
165	DIMENSION	X-99 D	54	CLAUS A. VON BÜLOW	8.20			L09:45	L18:28	L23:30:33	36:30:33	40:14:56+2	25
170	VIBSE	X-99 D	68	FINN BJERRE NIELSEN	8.20	F21:50	L06:17	L11:36	L21:02	S01:30:38	38:30:38	40:15:01	26
152	CUT	X-99 D	10	HANS HERLUF PEDERSEN	8.20	F21:19	L05:58	L10:12	L21:02	S01:34:19	38:34:19	40:18:42	27
179	ORKANEN	X-99 D	114	JESPER SAABYE	8.20	F21:22	L05:58	L11:15	L21:02	S01:45:53	38:45:53	40:30:16	28
169	EXPENSIVE	X-99 D	63	CHR. BENTZEN	8.20			L11:32	L21:05	S01:47:36	38:47:36	40:31:59	29
176	FREEDOM	X-99 D	103	LARS LINDING	8.20	F22:30		L12:22	L21:56	S02:13:04	39:13:04	40:57:27	30
167	EQUILIBRE	X-99 D	61	OLE SIEMSSSEN	8.20	F21:56	L06:46	L12:07	L22:05	S02:23:59	39:23:59	41:08:22	31
157	DEN BLÅ BANAN	X-99 D	26	HENRIK R HOLST	8.20	F21:58	L06:42	L12:02	L22:04	S02:25:57	39:25:57	41:10:20	32
154	VÆLTE PETER	X-99 D	21	TORBEN HØIBY	8.20	F21:08	L05:35	L10:42	L19:45	S00:41:04	37:41:04	41:25:27+2	33
181	MOSTER GRETA	X-99 S	118	HERMAN KARLIN	8.20	F21:56		L11:40	L21:02	S01:28:14	38:28:14	42:12:37+2	34
191	GRAFITTI	X-99 N	6541	ARNE OLAUSSEN	8.20					DISKVALIFICERET			
162	BIFROST	X-99 D	47	KURT HENRIKS	8.20					IKKE STARTET			
166	NON PLUS X	X-99 D	57	OLE SCHMIDT	8.20					IKKE STARTET			
185	EXTRA LADY	X-99 S	163	LARS LINDE	8.20					IKKE STARTET			
189	CANINUS	X-99 G	3438	HANS-PETER DOEHRING	8.20					IKKE STARTET			

RESULTATLISTE SJÆLLAND RUNDT 1988

2. START FREDAG 11:00 BANE 1 - GENNEM GRØNSUND

236 SØMIL

LØB 15 MOLICH 10M

NR. BÅDNAVN	TYPE	SEJLNR	BÅDENS FØRER	MÅL	ODDEN	AGERSØ	SKANSE	SALTH.	HELSINGØR	SEJLTID	POINTTID	PLAC
200 PERNILLE	MO.10M	D	30 PEER MOBRO	8.20	F20:43		L11:15	L19:32	S00:06:42	37:06:42	38:51:05	PR 1
202 PAPILLON	MO.10M	D	37 PETER ALEX JENSEN	8.20	F21:53	L06:02	L11:17	L19:41	S00:16:24	37:16:24	39:00:47	PR 2
197 ANNE IV	MO.10M	D	15 HANS HELWIGH	8.25	F20:53	L05:31	L10:51	L19:24	S00:11:01	37:11:01	39:01:25	PR 3
199 STRØM	MO.10M	D	29 STEEN WÆVERSTRØM	8.20			L11:42	L20:36	S01:10:51	38:10:51	39:55:14	4
198 JOKER III	MO.10M	D	25 NIELS EHRHARDT	8.20	F21:55	L06:27	L11:40	L21:00	S01:18:57	38:18:57	40:03:20	5
193 KANOK	MO.10M	D	6 JØRGEN SANDE	8.20					S01:20:27	38:20:27	40:04:50	6
196 ALBATROS	MO.10M	D	13 J. BERTHELTSEN	8.25			L11:42	L21:02	S01:27:41	38:27:41	40:18:05	7
195 EAGLE	MO.10M	D	9 DAN JOHNSON	8.20	F21:51		L11:37	L21:02	S01:35:01	38:35:01	40:19:24	8
194 AGNETE	MO.10M	D	7 FINN VIDEBÆK	8.20			L13:18	L22:48	S02:55:22	39:55:22	41:39:45	9
201 XANTIPPE	MO.10M	D	33 JESPER LIND HANSEN	8.25	F22:25	L07:21	L12:55	L22:30	S02:57:21	39:57:21	41:47:45	10
203 SAGA	MO.10M	D	41 PEER S. JØRGENSEN	8.20	F22:42	L07:18	L12:59	L22:20	S02:28:26	39:28:26	43:12:49+2	11
192 STYRBJØRN	MO.10M	D	2 JØRGEN MADSEN	8.25					IKKE STARTET			

LØB 16 YLVA

NR. BÅDNAVN	TYPE	SEJLNR	BÅDENS FØRER	MÅL	ODDEN	AGERSØ	SKANSE	SALTH.	HELSINGØR	SEJLTID	POINTTID	PLAC
220 AMIGO	YLVA	D	70 PEER JENSEN	8.20		L04:55	L09:45	L18:22	L23:14:31	36:14:31	37:58:54	PR 1
211 MARIE	YLVA	D	26 JAKOB JAKOBSEN	8.20	F20:31	L04:58	L10:01		L23:18:28	36:18:28	38:02:51	PR 2
204 BRUNHILDE	YLVA	D	3 LØVE/VINTER	8.20	F20:19	L04:53	L09:55	L18:28	L23:28:31	36:28:31	38:12:54	PR 3
217 SKUM	YLVA	D	50 JOHS. WÅIDTLØW	8.10			L10:13		L23:43:43	36:43:43	38:15:52	PR 4
208 BAGHEERA	YLVA	D	18 BRDR. GLAHN	8.10			L10:26		L23:44:02	36:44:02	38:16:11	5
205 LUDMILLA	YLVA	D	4 ERIK J. DANIELSEN	8.10	F20:44		L10:19	L18:47	L23:54:20	36:54:20	38:26:29	6
215 RINGHORNE	YLVA	D	43 JØRGEN POULSEN	8.20	F21:10	L05:30		L18:53	L23:43:56	36:43:56	38:28:19	7
212 PHILIPPA	YLVA	D	34 SVENN HENNINGSEN	8.20	F20:39	L05:28		L18:40	L23:59:50	36:59:50	38:44:13	8
222 LØVEHJERTE	YLVA	D	81 JOHN JALVING	8.20	F21:15	L05:39	L10:49	L19:25	S00:04:06	37:04:06	38:48:29	9
219 DEN RØDE LØBER	YLVA	D	69 LEIF PEHRSON	8.20	F21:49	L05:59	L10:04	L19:28	S00:04:46	37:04:46	38:49:09	10
210 KING FOUR TWO	YLVA	D	24 JØRN GRANKVIST	8.10	F21:56		L11:36	L20:16	S00:59:22	37:59:22	39:31:31	11
214 PNØ	YLVA	D	37 WENDELBOE/SØNDERBY	8.10	F22:23		L12:09	L21:50	S02:12:51	39:12:51	40:45:00	12
206 MARILYN	YLVA	D	8 JAN VALENTINI	8.10	F22:17		L12:41	L22:26	S02:32:30	39:32:30	41:04:39	13
207 RYTTERKNÆGTEN	YLVA	D	14 SØREN L. NIELSEN	8.10		L07:45	L13:10	L22:46	S02:49:50	39:49:50	41:21:59	14
209 ROSA FANTOMA	YLVA	D	21 KIM BO LARSEN	8.10	F21:56	L06:14	L11:25	L20:08	S00:51:41	37:51:41	41:23:50+2	15
213 ROSA	YLVA	D	36 BORUM/KOLRINGEN	8.10	F22:37	L07:33	L14:02	L23:43	S04:03:38	41:03:38	42:35:47	16
221 SIKÅ	YLVA	D	71 VAGN TOFT JENSEN	8.20	F21:20	L08:00	L13:27	L22:45	S02:46:37	39:46:37	43:31:00+2	17
216 LINCA 3	YLVA	D	45 CARSTEN POUL HANSEN	8.10					UDGÅET			
218 MORFEUS	YLVA	D	55 NIELS SVARØ	8.20					IKKE STARTET			

RESULTATLISTE SJÆLLAND RUNDT 1988

2. START FREDAG 11:00 BANE 1 - GENNEM GRØNSUND

236 SØMIL

LØB 17 DH 7.60 - 10.00

NR.	BÅDNAVN	TYPE	SEJLNR	BÅDENS FØRER	MÅL	ODDEN	AGERSØ	SKANSE	SALTH.	HELSINGØR	SEJLTID	POINTTID	PLAC
261	OFFSET	VAL 35	G 3595	JÜRGEN WASCHKE	8.00			L10:05	L18:28	L23:10:42	36:10:42	37:30:23	PR 1
237	FRK. OLSEN	DYNA.35	D 19	JENS H. OLSEN	8.30			L09:15	F17:50	L22:57:49	35:57:49	37:54:14	PR 2
241	GO BLUE	ELV.42	D 4	MADS MICHELSEN	8.15	F20:24	L04:41	L09:39	L18:25	L23:16:56	36:16:56	37:55:13	PR 3
236	PEGASUS	DYNA.35	D 18	PETER M. THOMSEN	8.35		L04:26	L09:15	F17:51	L22:57:25	35:57:25	37:59:44	PR 4
238	STOPPENÅLEN	DYNA.35	D 30	BJARNE RIIS	8.30			L18:16	L23:06:31	36:06:31	38:02:56	PR 5	
244	TULLE	OME.42S	D 120	THOMAS EKDAHL	8.30	F20:41		L10:10		L23:22:41	36:22:41	38:19:06	PR 6
233	MORGAN	DIVA 35	S 9051	LENNART INGERS	8.20	F20:19	L04:58	L10:03	L18:38	L23:42:25	36:42:25	38:26:48	PR 7
245	AGEMO	OME.42S	D 141	SØREN K LARSEN	8.30	F20:49		L10:04	L18:28	L23:32:16	36:32:16	38:28:41	PR 8
240	CHEBEC	DYNA.35	D 47	MICHAEL CHRISTIANSEN	8.30		L05:36	L10:31	L18:53	L23:33:56	36:33:56	38:30:21	PR 9
235	FLYING SAILOR	DYNA.35	D 2	CARSTEN MOGENSEN	8.35	F21:15		L10:27	L18:49	L23:36:21	36:36:21	38:38:40	10
251	ILYA	ONYX	S 1	GÖTE BERG	8.60	20:46	L04:54	L09:42	L18:25	L23:16:17	36:16:17	38:47:31	11
252	RAGNAROK	RAV.36	D 6	BERTHIL BUCH	8.30	F20:00	L05:25	L10:27	L19:04	S00:00:50	37:00:50	38:57:15	12
227	HAVHESTEN	CONC38	D 25	SØREN BECH	7.65	F20:12	L06:02	L11:15	L20:36	S01:24:48	38:24:48	38:59:05	13
223	SABRINA	A A 12	D 2	POUL BORCHUM	8.65	F20:27	L04:54	L09:51	L18:32	L23:28:48	36:28:48	39:05:42	14
255	IRIS	SIREN38	D 68	CARSTEN GRUBB	8.15		L05:35	L10:49	L19:44	S00:31:25	37:31:25	39:09:42	15
246	CONCORDE	OME.CON	S 1	LARS HARALDSSON	9.20		L04:21	L09:06	F17:45	L22:39:05	35:39:05	39:15:01	16
248	OUTLAW	OMG.42	D 97	T. STORM NIELSEN	8.45	F21:21		L09:43	L19:25	S00:04:16	37:04:16	39:18:18	17
230	N.N.	DIVA 35	S 28	ULF LEEMAN	8.25	F20:59	L05:35	L10:51	L19:50	S00:34:02	37:34:02	39:24:26	18
259	MISS G	SWEDE38	S 1	OTTO CLAUSEN	7.70	F21:00	L05:54		L21:02	S01:46:21	38:46:21	39:27:17	19
239	SØ-FINE	DYNA.35	D 36	MARLENE BRASCH	8.30	F21:33	L05:51	L10:59	L19:55	S00:35:54	37:35:54	39:32:19	20
226	SULEJMA	CONC38	D 7	KLAUS GJDE	7.60		L06:52	L12:05	L21:37	S02:05:31	39:05:31	39:33:05	21
231	HELENE	DIVA 35	D 29	TORBEN LIND	8.30	F20:44	L05:35	L10:53	L20:04	S00:46:57	37:46:57	39:43:22	22
247	JOFUS	OMG.42	D 3	KIM ANDERSEN	8.40	F21:51		L10:07	L19:58	S00:38:21	37:38:21	39:46:34	23
262	PAPAYA	WASA 38	D 54	SVEND ERIK DAHLMANN	8.25	F21:04		L10:10	L20:16	S01:03:56	38:03:56	39:54:20	24
253		RAV.36	S 31	MATS JÖNSSON	8.35	F21:53	L06:17	L11:36	L20:31	S01:09:21	38:09:21	40:11:40	25
257	FRU HANSEN	SOLUS40	D 1	ERNST HANSEN	9.60	F20:11		L09:11	F17:55	L22:56:07	35:56:07	40:11:56	26
225	SIRENEN	CONC115	D 30	ANDERS HØEGH POST	8.10	F20:13	L06:02	L11:15	L21:05	S01:43:09	38:43:09	40:15:18	27
309	CHERI	LUFF37	D 50	STEEN HABERSAAT	7.70		L06:13	L12:57	L22:35	S02:45:32	39:45:32	40:26:28	28
243	PHANTOM	HELMCA	D 32	MICHAEL SUND-NIELSEN	7.80	F21:00	L07:19	L12:57	L22:56	S03:06:22	40:06:22	41:00:29	29
229	FILIPPA	CONQ.38	116	CHRISTER HOLMBERG	7.80	F22:37		L13:10	L22:50	S03:07:36	40:07:36	41:01:43	30
249	PRETTY NAMA	ONE 10M	D 2	MICHAEL JENSEN	8.10	F22:07		L12:29	L22:15	S02:30:02	39:30:02	41:02:11	31
258	CLEAR-WATER	SUNS.38		HANS-DIETER SAUERBERG	8.10	F22:23	L07:20	L12:55	L22:38	S02:55:11	39:55:11	41:27:20	32
250	FIRST LOVE	ONE 10M	D 70	CARSTEN S. RASMUSSEN	8.15	F22:33		L13:21	L22:58	S03:05:02	40:05:02	41:43:19	33
260	KVIK	SWEDE38	D 54	KURT HANSEN	7.80			L13:19		S04:00:36	41:00:36	41:54:43	34
256	SIRENA	SIREN38	D 80	ARILD NORDAHL	8.20			L13:38	S00:11	S04:27:34	41:27:34	43:11:57	35
254	BLÅTUNGA	RHAP.43	39	BRIAN KOGGE	10.00	F22:15	L06:49	L12:05	L21:34	S01:54:08	38:54:08	43:47:28	36
228	RASKES	CONC38	D 27	STEN HOLMFRID-JONASSON	7.40	L23:50	L09:21	L16:12		S09:33:15	46:33:15	46:33:15	37
224	MISS GARFIELD	C-10 M	D 4	NIELS ULSTRUP	8.00	F20:02	L05:17	L10:27		UDGÅET			
232	DIVANN	DIVA 35	S 60	BENGT LINDQUIST	8.30					IKKE STARTET			
234	BAHIA	DRAGØ36	D 936	CRISTIAN LIMA	8.20					IKKE STARTET			
242	FINNGUFF	FINN.39	D 28	KNUD ERIK JUHL	8.35					IKKE STARTET			

LØB 17a SÆRLIGT LØB (PLACERING EFTER POINTTID I LØB 17)

NR.	BÅDNAVN	TYPE	SEJLNR	BÅDENS FØRER	MÅL	ODDEN	AGERSØ	SKANSE	SALTH.	HELSINGØR	SEJLTID	POINTTID	PLAC
173	MOR KAREN	X-99	D 96	KNUD HANSEN	8.10	F20:35		L10:19	L18:55	L23:56:57	36:56:57	38:29:06	PR 9

LØB 18 CAYENNE

NR.	BÅDNAVN	TYPE	SEJLNR	BÅDENS FØRER	MÅL	ODDEN	AGERSØ	SKANSE	SALTH.	HELSINGØR	SEJLTID	POINTTID	PLAC
264	DANZUINSA	CAYENNE	D 65	HENRIK JANSEN	8.45	F21:07	L05:14	L10:09	L18:28	L23:13:00	36:13:00	38:27:02	PR 1
272	PEPPERY	CAYENNE	D 106	KAI JØRGENSEN	8.40	F20:30	L05:10	L10:16	L18:43	L23:33:05	36:33:05	38:41:18	PR 2
270	NANOQ	CAYENNE	D 102	JØRGEN OLSEN	8.45	F21:12	L05:26	L10:27	L18:47	L23:35:53	36:35:53	38:49:55	PR 3
265	DERUDA'	CAYENNE	D 66	HJORTH/PAGSBERG	8.45	F20:59	L05:14	L10:16	L18:47	L23:36:59	36:36:59	38:51:01	4
266	MISS PEPPER	CAYENNE	D 80	OLE CORTZEN	8.45		L05:30	L10:27	L18:49	L23:38:25	36:38:25	38:52:27	5
267	KORAL	CAYENNE	D 88	JEAN MØRCK	8.45	F20:53		L10:03		L23:40:20	36:40:20	38:54:22	6
268	TOOTSIE II	CAYENNE	D 96	OLE GJEDVED	8.50	F21:00		L10:16	L18:50	L23:45:23	36:45:23	39:05:12	7
271	GEORGINE	CAYENNE	D 104	THOMAS BRY	8.45			L10:36		S00:01:36	37:01:36	39:15:38	8
273	FILIPINA	CAYENNE	D 110	EDWARD KANHOLM	8.45					S00:11:17	37:11:17	39:25:19	9
263	NEW MOON	CAYENNE	31	NILS NOBREUS	8.50	F20:43		L10:53	L19:32	S00:09:21	37:09:21	39:29:10	10
1779	HIAWATHA	CAYENNE	13	LEIF HULTMAN	8.50	F20:59		L10:04	L20:14	S00:57:12	37:57:12	40:17:01	11
269	RURIK	CAYENNE	98	GUNNAR R.A. DRAGO	8.65					IKKE STARTET			

RESULTATLISTE SJÆLLAND RUNDT 1988

3. START FREDAG 11:30 BANE 1 - GENNEM GRØNSUND

236 SØMIL

LØB 20 BIANCA 111

NR.	BÅDNAVN	TYPE	SEJLNR	BÅDENS FØRER	MÅL	ODDEN	AGERSØ	SKANSE	SALTH.	HELSEINGØR	SEJLTID	POINTTID	PLAC	
277	MY-WAY	BIA.111 D	27	FRANK BERG	7.40				L12:14	L22:00	S02:15:49	38:45:49	41:04:39	PR 1
276	LURIFAX	BIA.111 D	20	STIIG JØRGENSEN	7.45				L12:22	L22:07	S02:29:08	38:59:08	41:24:56	PR 2
280	TEMPTATION	BIA.111 D	60	JOHN REEDTZ	7.50				L12:30	L22:20	S02:37:27	39:07:27	41:40:13	3
283	GORFIN	BIA.111 D	69	CARSTEN BJERNÅ	7.55				L12:50	L22:35	S02:48:27	39:18:27	41:58:03	4
282	TOOTSIE	BIA.111 D	67	MAX NIELSEN	7.50				L13:10		S03:00:22	39:30:22	42:03:08	5
278	TRES BIEN	BIA.111 D	31	MICHAEL FRISENSTEN	7.50				L13:04	L22:46	S03:14:19	39:44:19	42:17:05	6
274	BEE BOB	BIA.111		ALLAN CHRISTENSEN	7.80				L12:59	L22:44	S02:56:08	39:26:08	42:39:06	7
281	CAVU	BIA.111 D	65	HANS STENFELDT HANSEN	7.55	F21:58	L06:40		L12:02	L21:26	S01:53:23	38:23:23	43:02:59+2	8
275	ATHENE	BIA.111 D	17	PETER E. NAUMANN	7.70		L08:10		L13:58	L23:45	S04:09:00	40:39:00	43:38:47	9
279	SEAMATE	BIA.111 B	38	SØREN ELVIN-JENSEN	7.40								IKKE STARTET	

LØB 21 DRABANT 38

NR.	BÅDNAVN	TYPE	SEJLNR	BÅDENS FØRER	MÅL	ODDEN	AGERSØ	SKANSE	SALTH.	HELSEINGØR	SEJLTID	POINTTID	PLAC	
294	POSEIDON	DRA.38 D	40	KAJ HANSEN	7.90	F20:50			L10:12	L18:33	L23:22:29	35:52:29	39:18:21	PR 1
291	MATADOR	DRA.38 D	28	THORBEN DAMSGAARD	8.40		L05:14		L10:15		L23:25:22	35:55:22	40:22:26	PR 2
295	BALANC-SINE	DRA.38 D	44	KNUD ANDERSEN	8.15	F21:08	L06:03		L11:20	L19:57	S00:29:56	36:59:56	40:57:04	PR 3
287	DRABANT	DRA.38 D	10	TORBEN WITH	8.15	F22:17	L06:29		L11:36	L20:02	S00:37:57	37:07:57	41:05:05	PR 4
289	REBECCA	DRA.38 D	19	PALLE NIELSEN	7.85	F21:45			L11:37	L21:02	S01:32:54	38:02:54	41:22:21	5
285	SKRÆP	DRA.38 D	8	HANS MANDRUP ANDERSEN	7.90	F21:58	L06:29		L11:39	L20:57	S01:30:07	38:00:07	41:25:59	6
292	WHISKER	DRA.38 D	29	LENNART MICHELSEN	7.85	F20:58	L05:17		L10:26		L23:52:28	36:22:28	41:41:55+2	7
286	PUSSYCAT	DRA.38 D	9	F TEILMANN NIELSEN	7.90		L07:06		L12:14	L21:27	S01:48:55	38:18:55	41:44:47	8
284	PEQUOD	DRA.38 D	7	PETER M PEDERSEN	8.15	F21:56			L11:47	L21:10	S01:39:27	38:09:27	42:06:35	9
1781	PELLE	DRA.38 D	14	HENNING STOFFER	8.05		L07:40		L13:04	L22:26	S02:33:41	39:03:41	42:48:28	10
298	AVANTI	DRA.38 D	50	PETER GUNNAR PETERSEN	8.15	F22:23			L12:30	L22:10	S02:21:59	38:51:59	42:49:07	11
290	THERESE	DRA.38 D	24	HELGE PETERSEN	8.20	F22:33	L07:10		L12:29	L22:06	S02:18:56	38:48:56	42:52:10	12
296	LURIFAX	DRA.38 D	45	BIRGER TUE CHRISTENSEN	7.95	F21:56	L06:22		L11:37	L20:34	S01:05:29	37:35:29	43:07:43+2	13
293	NIELSEN-LINE	DRA.38 D	30	JAN B. NIELSEN	8.10	F21:22			L10:04	L20:08	S00:56:34	37:26:34	43:17:34+2	14
288	XTRA	DRA.38 D	11	OLE WIND	8.05								IKKE STARTET	
297	CAMELOT	DRA.38 D	46	JENS N CHRISTIANSEN	8.00								IKKE STARTET	

LØB 22 LUFFE 37

NR.	BÅDNAVN	TYPE	SEJLNR	BÅDENS FØRER	MÅL	ODDEN	AGERSØ	SKANSE	SALTH.	HELSEINGØR	SEJLTID	POINTTID	PLAC	
307	SIV IV	LUFF37 D	45	JESPER BÜLOW SIVERTSEN	7.85	F21:11			L10:32		L23:51:08	36:21:08	39:40:35	PR 1
319	ISABELLE DESIRE	LUFF37 D	77	HENRIK NIELSEN	7.85	F21:20	L05:39		L10:43	L19:35	S00:15:06	36:45:06	40:04:33	PR 2
312	KRABASK	LUFF37 D	59	POUL ERIK THOMSEN	7.85	F21:19	L05:45		L10:53	L19:42	S00:23:42	36:53:42	40:13:09	PR 3
322	WHOOPEE	LUFF37 D	88	BERNT HANSEN	7.85				L11:50	L20:53	S01:18:35	37:48:35	41:08:02	PR 4
329	BALOO	LUFF37 D	130	TORBEN T. OLESEN	7.85	F21:50	L06:26		L11:36	L21:02	S01:32:44	38:02:44	41:22:11	PR 5
310	JAQUELINE	LUFF37 D	51	HUGO NIELSEN	7.85	F22:06	L06:32		L11:44	L21:06	S01:39:20	38:09:20	41:28:47	PR 6
303	BARBARA	LUFF37 D	16	ROBERT GABRIEL-JENSEN	7.85	F22:19	L06:46		L11:59	L21:16	S01:41:52	38:11:52	41:31:19	7
299	CLARA	LUFF37 D	5	KNUT LINDAU	7.85	F21:51			L11:20	L21:10	S01:44:16	38:14:16	41:33:43	8
323	LONI	LUFF37 D	90	FL. PETERSEN	7.85				L12:02	L21:24	S01:44:45	38:14:45	41:34:12	9
317	TED	LUFF37 D	71	MOGENS LARSEN	7.85	F22:17	L06:49		L12:02	L21:24	S01:55:19	38:25:19	41:44:46	10
308	MARIE-LOUISE	LUFF37 D	48	HENRI EISENHARDT	7.85		L06:54		L12:14	L21:52	S02:16:54	38:46:54	42:06:21	11
316	KARINA	LUFF37 D	68	JENS ESPERSEN	7.85		L07:15		L12:37	L22:06	S02:17:40	38:47:40	42:07:07	12
328	PINK LADY	LUFF37 D	126	BIRGER SCHEUFENS	7.85	F22:30	L07:07		L12:27	L22:07	S02:19:38	38:49:38	42:09:05	13
311	ALPOHAJE	LUFF37 D	57	POUL SVENDSEN	7.85	F22:39	L07:18		L12:45	L22:08	S02:22:37	38:52:37	42:12:04	14
302	SOLKA	LUFF37 D	14	JØRN REDANZ	7.85	F22:26	L07:07		L12:29	L22:06	S02:23:07	38:53:07	42:12:34	15
320	MAFIA	LUFF37 D	86	ULF SCHNACK	7.85				L12:55	L22:16	S02:25:35	38:55:35	42:15:02	16
327	UTOPIA	LUFF37 D	114	BENT NYGAARD	7.85				L12:59	L22:22	S02:26:53	38:56:53	42:16:20	17
326	FLEUR	LUFF37 D	109	MOGENS HOLBØLL	7.85	F22:19	L07:07		L12:27	L22:10	S02:28:39	38:58:39	42:18:06	18
301	CALIGULA	LUFF37 D	8	JØRGEN SUNDAHL	7.85	F22:37			L12:45	L22:15	S02:30:00	39:00:00	42:19:27	19
315	SPRAY	LUFF37 D	67	FLEMMING VOSS	7.85	F22:44			L12:55	L22:22	S02:32:22	39:02:22	42:21:49	20
313	PERNILLE	LUFF37 D	63	POUL SNORGÅRD	7.85				L12:43	L22:24	S02:41:48	39:11:48	42:31:15	21
318	FRK. CHRISTINA	LUFF37 D	72	ERLING K. PEDERSEN	7.85				L12:59	L22:30	S02:45:26	39:15:26	42:34:53	22
321	SAIGA	LUFF37 D	87	ERIK BLICHFELD	7.85		L07:42		L13:05	L22:44	S02:50:18	39:20:18	42:39:45	23
324	MISS M.	LUFF37 D	95	BO LYNDGAARD	7.85		L07:45		L13:17	L22:50	S02:55:32	39:25:32	42:44:59	24
304	ONGO BONGO	LUFF37 D	35	PALLE HANSEN	7.85				L13:04	L22:44	S02:56:59	39:26:59	42:46:26	25
305	RIE	LUFF37 D	36	JESPER TROLLE	7.85				L13:04	L22:48	S03:08:05	39:38:05	42:57:32	26
325	RUTH IV	LUFF37 D	104	PALLE RINGSTRØM	7.85		L08:01		L13:32	L22:58	S03:11:17	39:41:17	43:00:44	27
300	KIRSTINE	LUFF37 D	6	JENS TRØDE	7.85		L08:10		L13:59	L23:45	S04:10:34	40:40:34	44:00:01	28
306	GALADRIEL	LUFF37 D	38	FLEMMING PREISLER	7.85	F22:27	L07:10						UDGÅET	
314	TRUNTE	LUFF37 D	64	AAGE GALSKOV	7.85								IKKE STARTET	

RESULTATLISTE SJÆLLAND RUNDT 1988

3. START FREDAG 11:30 BANE 1 - GENNEM GRØNSUND

236 SØMIL

LØB 23 X-102

NR.	BÅDNAVN	TYPE	SEJLNR	BÅDENS FØRER	MÅL	ODDEN	AGERSØ	SKANSE	SALTH.	HELSINGØR	SEJLTID	POINTTID	PLAC
334	CHESS	X-102	D 130	ERWIN HOELGAARD	7.20	F21:51	L06:35	L11:55	L21:24	S01:53:37	38:23:37	40:13:47	PR 1
348	EARL GREY	X-102	D 1184	PETER IVERSEN	7.20	F21:56	L06:44	L12:05	L21:37	S02:04:25	38:34:25	40:24:35	PR 2
331	THIELE BRILLER	X-102	D 82	JØRGEN TJELLESEN	7.20			L12:05	L21:45	S02:07:57	38:37:57	40:28:07	PR 3
341	LURIFAX	X-102	D 162	HANS ULRIKKEHOLM	7.20	F22:19	L07:15	L12:43	L22:21	S02:39:00	39:09:00	40:59:10	PR 4
345	WHITE LADY	X-102	D 1137	AA BACH KRISTENSEN	7.20		L07:48	L13:26	L23:03	S03:17:02	39:47:02	41:37:12	5
338	KALAS	X-102	D 150	HENRIK CARLSEN	7.35		L07:45	L13:13	L22:55	S03:04:42	39:34:42	41:46:28	6
342	MIX	X-102	D 164	PETER SKJOLDBORG OLSEN	7.45	F22:33	L07:30	L13:04	L22:44	S02:55:43	39:25:43	41:51:31	7
330	DEVOTION	X-102	D 21	HARALD FALKENTOFT	7.40	F22:30		L13:05	L22:58	S03:21:11	39:51:11	42:10:01	8
336	X-TRAVAGANCE	X-102	D 140	PETER BUHL	7.40	F22:39		L13:19	L23:03	S03:22:17	39:52:17	42:11:07	9
346	EXTREME	X-102	D 1167	JAN MØLHOLM	7.40	F22:35		L13:17	L23:03	S03:36:51	40:06:51	42:25:41	10
332	RIMFAXE	X-102	D 92	CHRISTENSEN/THOMASSEN	7.45	F22:37		L13:39	L23:30	S03:45:48	40:15:48	42:41:36	11
333	EXIT	X-102	D 121	CLAUS JØRGENSEN	7.40		L07:21	L13:47	L23:30	S04:02:28	40:32:28	42:51:18	12
340	BLÅLYS	X-102	D 160	WILLIAM SEIER	7.10			L13:37		S04:49:02	41:19:02	42:54:25	13
339	X-MERALDA	X-102	D 153	PETER THYGESEN	7.30		L08:00	L13:37		S04:29:36	40:59:36	43:04:14	14
347	X-TASE	X-102	D 1169	FLEMMING MICHAELSEN	7.30		L08:15	L13:58		S04:31:16	41:01:16	43:05:54	15
337	BELLATRIX	X-102	D 146	S.PEDERSEN/JENS J. JENSEN	7.65	L23:49	L08:54	L14:27		S06:28:24	42:58:24	45:51:32	16
349	FAX	X-102	N 3547	MORTEN FALLET	7.25			L14:46	S00:40	S05:56:05	42:26:05	46:23:31+2	17
335	X-IL	X-102	D 132	JESPER SCHWANENFLÜGEL	7.30					IKKE STARTET			
343	VANDMULEN	X-102	D 1107	JOACHIM NICKELSEN	7.15					IKKE STARTET			
344	UB	X-102	D 1118	T. PEDERSEN	7.15					IKKE STARTET			

LØB 24 DH 8.05 - 8.80

NR.	BÅDNAVN	TYPE	SEJLNR	BÅDENS FØRER	MÅL	ODDEN	AGERSØ	SKANSE	SALTH.	HELSINGØR	SEJLTID	POINTTID	PLAC
354	EXCALIBUR	X-372	D 30	HENRIK C MARCHER	8.30	F21:05	L05:33	L10:37	L19:35	S00:13:17	36:43:17	40:58:33	PR 1
350	O'DREAM	BIA.420	D 1235	BERNHARD BLIKSBY	8.95	F21:13		L10:31		L23:46:24	36:16:24	41:44:59	PR 2
355	MATCHBOX	X-372	D 43	POUL VORM	8.20	F21:41		L11:31	L21:05	S01:30:48	38:00:48	42:04:02	3
352	DAIQUIRI	COMP363	S 28	LARS LUNDBLAD	8.05	F22:17	L07:06	L12:22	L21:58	S02:07:41	38:37:41	42:22:28	4
353	KAT-PET	PUZZ.39	D 4	PETER OLSEN	8.65	F22:23		L12:45	L22:25	S02:37:09	39:07:09	44:02:53	5
351	JANE	COM. 38	D 60	SØREN JUSTESEN	8.20					IKKE STARTET			
356	LANCING	X-372	S 9016	LEIF ANDERSSON	8.40					IKKE STARTET			
1774	MITRAS	DYN. 37	D 1219	VOLKER ZIKK	7.85					IKKE STARTET			

LØB 25 DH 6.50 - 7.55

NR.	BÅDNAVN	TYPE	SEJLNR	BÅDENS FØRER	MÅL	ODDEN	AGERSØ	SKANSE	SALTH.	HELSINGØR	SEJLTID	POINTTID	PLAC
1164	GLOBALFINA	ARCO.36	D 7	OVE SKOVGÅRD-MORTENSEN	7.60	F21:31	L06:00		L20:18	S01:02:30	37:32:30	40:18:55	PR 1
360	XANTIPPE	ALB.STR	G 8775	KARL-HEINZ STRYI	6.70		L08:04	L13:45	L23:30	S03:51:04	40:21:04	40:54:13	PR 2
358	TUSINDFRYD	ALB.STR	D 87	CHRISTEN KOCH	6.90		L07:59	L13:39	L23:08	S03:23:54	39:53:54	40:58:50	PR 3
381	SKYLIGHT	ONE-OFF	468	KAJ BÄCK	6.85				L23:20	S03:44:51	40:14:51	41:11:57	PR 4
361	BELVENI	BAN33R	D 24	JENS TOFT	6.95		L08:01		L23:36	S04:01:13	40:31:13	41:43:51	PR 5
377	SIMONE	KASKELO	D 41	NIELS HENNING JOHANSEN	7.30			L13:28	L23:03	S03:21:57	39:51:57	41:56:35	PR 6
371	RIKKE RASK	GRAN340	D 24	KIM M. DITHMAR	7.15			L13:44		S03:58:36	40:28:36	42:11:25	7
370	JULIANE	GRAN.34	D 31	FLEMMING WITTRUP	7.15	L00:36	L08:15	L14:00	L23:45	S04:15:44	40:45:44	42:28:33	8
368	MOLAR	GRAN.34	D 5	LARS KJØRUP	7.20			L14:04	L23:45	S04:17:22	40:47:22	42:37:32	9
379	LONE	KASKELO	D 768	HOLGER HARTLEV	7.20	L23:29		L14:20	L23:55	S04:26:48	40:56:48	42:46:58	10
366	SVIFS	ELAN.33	D 243	FLEMMING DALUM	6.50			L14:47	S00:40	S06:32:23	43:02:23	43:02:23	11
372	JANA	GRAN340	G 3509	HANS PETER SASS	7.55	L23:23	L08:15	L13:54	L23:36	S04:03:45	40:33:45	43:13:21	12
365	FLASH	ELAN.33	D 129	CLAUS AGNSTOFT	6.80	L23:55	L09:05	L14:57		S06:42:59	43:12:59	44:02:11	13
375	WESTWIND III	HINR34	D 934	CHR. FABRICIUS	6.90	L23:34	L09:00	L15:00		S06:32:50	43:02:50	44:07:46	14
376	PENELOPE	KASKELO	D 28	PER JAKOBSEN	6.85			L14:53		S06:53:43	43:23:43	44:20:49	15
364	MALOU	ELAN.33	D 77	FLEMMING FLETHØJ	6.85	L23:32		L14:53		S07:55:13	44:25:13	45:22:19	16
369	NØLLE	GRAN.34	D 10	JENS LIPPMANN	7.45	L00:02		L15:12		S06:35:20	43:05:20	45:31:08	17
362	MISS SUNSHINE	CENIT33	D 51	FLEMMING ANDERSEN	7.05	L23:22	L08:55	L14:49		S08:01:49	44:31:49	45:59:43	18
382	PAPER MOON	WASA 31	S 9903	BØRGE MAHLER	7.05	L23:55	L09:21	L15:16		S08:07:53	44:37:53	46:05:47	19
367	DOUBLE TROUBLE	FIRS345	D 600	JOHN GUNN	7.25	L00:36		L16:26		S08:36:11	45:06:11	47:03:37	20
373	LAURA	HEMLA	D 8	KURT KEHLER	7.45	L23:22		L15:23		S08:12:48	44:42:48	47:08:36	21
378	COCODRILLO	KASKELO	D 45	CLAUS GYLICHE	7.50		L10:37	L16:28		S08:34:54	45:04:54	47:37:40	22
374	ERICA II	HINR34	D 678	ERIK LETH HANSEN	6.90		L12:00	L17:54		S11:16:26	47:46:26	48:51:22	23
363	TIME OFF	CENIT33	D 64	JAN KRISTOFFERSEN	6.75	L01:25	L12:13	L17:47	S09:35	S16:41:33	53:11:33	53:52:46	24
399	APOLLONIA	FAUR.33	D 8	JØRGEN LANG	7.00	F22:33				UDGÆT			
359	MARIE III	ALB.STR	D 1102	G. JUHL MADSEN	6.70					IKKE STARTET			
380	MADONNA	KASKELO	D 7811	HAGEN ØDUM	7.10					IKKE STARTET			

RESULTATLISTE SJÆLLAND RUNDT 1988

3. START FREDAG 11:30 BANE 1 - GENNEM GRØNSUND

236 SØMIL

LØB 26 DH 6.80 - 8.40

NR.	BÅDNAVN	TYPE	SEJLNR	BÅDENS FØRER	MÅL	ODDEN	AGERSØ	SKANSE	SALTH.	HELINGØR	SEJLTID	POINTTID	PLAC
391	MAJ BRITT	CONT.36 D	133	AXEL HOLM	7.25		L08:01	L12:43	L22:20	S02:30:50	39:00:50	40:58:16	PR 1
422	EXOCET	X-3/4T D	1176	JAN NIELSEN	7.40	F22:25		L12:37	L22:20	S02:35:54	39:05:54	41:24:44	PR 2
394	LUNTE	CONT.36 D	102	KARL E NIELSEN	7.25			L13:21	L22:55	S03:00:09	39:30:09	41:27:35	PR 3
395	NELLE	CONT.36 D	119	H H NISSEN	7.35	F22:37		L13:04	L22:37	S02:48:04	39:18:04	41:29:50	PR 4
389	LEOPARDEN	COMP.36 D	49	OTTO VORNØE	7.45	F22:40		L13:04	L22:37	S02:46:08	39:16:08	41:41:56	PR 5
419	REBECCA	RB 111 S	30	STEFAN GUSTAFSSON	7.50	F22:33	L07:16	L12:55	L22:26	S02:41:29	39:11:29	41:44:15	PR 6
410	MICHELLE	NORL37 D	674	OTTO THIND	7.60	F22:07	L07:07	L12:37	L22:15	S02:27:53	38:57:53	41:44:18	PR 7
392	GISSER	CONT.36 D	69	LEIF PETERSEN	7.40	F22:38		L13:10	L22:46	S02:57:42	39:27:42	41:46:32	PR 8
411	CARTE BLANCHE	NORL37 S	8995	BO JOHANSSON	7.60	F21:58		L12:22	L22:08	S02:30:19	39:00:19	41:46:44	9
409	MAM MAM	MAMBA36 D	106	JENS SCHELLE	7.50		L07:44	L13:17	L22:48	S03:03:21	39:33:21	42:06:07	10
415	RAPPEDULLEN	OME.36 D	51	JØRGEN HOLST	7.90		L07:10	L12:37	L22:02	S02:14:44	38:44:44	42:10:36	11
408	KIR II	MAMBA36 D	102	JES HAGEMANN	7.45		L08:05	L13:43	L23:15	S03:21:46	39:51:46	42:17:34	12
401	OFELIA	FAURBY D	42	HELGE JENSEN	7.95	F21:37		L11:42	L21:30	S02:15:32	38:45:32	42:17:46	13
150	NINETY-NINE	X-99 D	1	LAU DIGMANN	7.85	F22:07		L12:22	L22:11	S02:28:46	38:58:46	42:18:13	14
400	RÆVEPELSEN	FAURBY D	30	JØRGEN ADSBØL	7.90		L07:26	L12:55	L22:21	S02:30:31	39:00:31	42:26:23	15
416	JOLLY JOKER	OME.36 D	57	SVEN E. PERSSON	7.90		L07:21	L12:50	L22:16	S02:31:17	39:01:17	42:27:09	16
418	KALI KI	ONE-OFF D	1	INGOLF P ANDERSEN	7.65		L08:01	L13:38	L23:00	S03:15:26	39:45:26	42:38:34	17
417	CARISMA	OME.36 S	60	GÖRAN SANDBERG	7.90			L13:04	L22:44	S02:52:57	39:22:57	42:48:49	18
390	SØS-PIGE	COMP.36 D	68	HENNING SVENDSEN	7.70		L08:12	L13:59	L23:16	S03:23:44	39:53:44	42:53:31	19
397	WHITE LADY	CTSA35 D	5905	FINN BEHRENDT SØRENSEN	7.60		L07:58	L13:38	L23:25	S03:42:42	40:12:42	42:59:07	20
387	ABELONE	BIA.107 D	35	STEEN TAUL-JENSEN	7.60		L07:59	L13:37	L23:25	S03:45:10	40:15:10	43:01:35	21
383	HANEGAL	BIA.107 D	7	MOGENS BANG	7.60		L07:59	L13:36		S03:52:04	40:22:04	43:08:29	22
414	GLIM	OME.36 D	17	N. VALENTIN HANSEN	7.85		L08:08	L13:22	L23:17	S03:32:40	40:02:40	43:22:07	23
385	JOMFRU DITTE	BIA.107 D	20	BENNY SKOV	7.40		L08:17	L14:04	L23:55	S04:37:05	41:07:05	43:25:55	24
388	BOLETTE	BIA.107 D	1210	ULRIK BARTHOLDY	7.60		L08:10	L13:49	L23:47	S04:20:10	40:50:10	43:36:35	25
386	DIVA	BIA.107 D	34	TED GRÄSLUND	7.55		L08:23	L14:00		S04:34:32	41:04:32	43:44:08	26
402	BINDE-GAL	FAURBY D	58	BJARNE NIELSEN	7.70		L08:17	L14:00	S00:00	S04:27:16	40:57:16	43:57:03	27
420	WAKISA	WAS360 D	1110	HENNING KRISTENSEN	7.90		L08:17	L14:07	L23:47	S04:10:13	40:40:13	44:06:05	28
393	ISABEL	CONT.36 D	99	SØREN BYSTED	7.35	L00:02		L15:00		S05:36:55	42:06:55	44:18:41	29
406	TOPI	GIB.105 D	105	TORBEN B. CHRISTENSEN	7.15	L23:47	L08:54	L14:44		S06:59:27	43:29:27	45:12:16	30
403	CHATEAU	FAURBY D	61	ANDERS BORG	8.00	L23:55		L14:39		S05:15:33	41:45:33	45:24:05	31
407	QUELLE	MAGL.35 D	1	SØREN AMMITZBØLL	7.60	L00:02	L09:30	L15:07	S01:00	S07:28:55	43:58:55	46:45:20	32
405	CIRKELINE	FEE1040 D	67	JOHNNY MALMER	7.90		L11:15	F17:05		S09:48:32	46:18:32	49:44:24	33
404	MALOO	FEE1040 D	56	BJARNE JENSEN	6.80		L12:25	L18:53	S06:45	S14:31:26	51:01:26	53:50:38+2	34
396	NUUK	CONT.36 D	147	JØRGEN LAUGE LAUGESEN	7.25					UDGÆT			
412	CEST LA VIE	OME.36 S	1	KJELL-BÖRJE GRENDER	7.90	F22:23	L06:56	L12:07	L21:20	DISKVALIFICERET			
384	DENANDEN	BIA.107 D	11	JESPER BONDE	7.65					IKKE STARTET			
413	BRITT	OME.36 D	4	PETER CHRISTENSEN	8.05					IKKE STARTET			
421	BOUQUET	WASA30 D	12	HENRIK KRISTENSEN	8.40					IKKE STARTET			

Den intelligente beslutning.

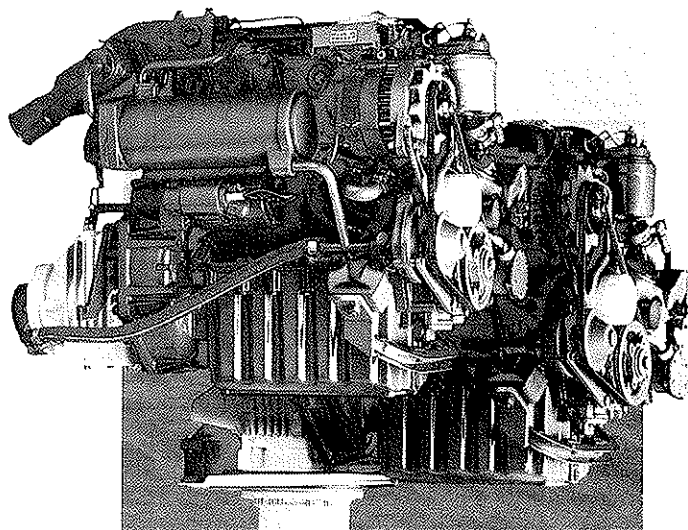

En-, to- eller tre-
cylindrede motorer
med et usædvanligt



kompakt design, udviklet og konstrueret for at kunne tilbyde sejlerne bedre indenbordsmotorer. 2000 Serien giver sejlerne motorer med lavt brændstofforbrug, let adgang til alle servicesteder, mere magt over båden ved manøvrer i dårligt vejr, lav vægt i forhold til ydelsen samt meget små indbygningsmål. Alle motorer kan leveres med VOLVO PENTA'S tilpassede transmissioner, uanset om ønsket er almindeligt gear, vinkelgear eller det avancerede S-drev. Transmissioner udviklet specielt til disse motorer, således at sejlerne får den maksimale udnyttelse af den til rådighed værende kraft.

Følgende europæiske motor/sejlbådsbyggere har taget den fornuftige beslutning at forsyne deres både med motorer og transmissioner fra Volvo Penta's omfattende marineprogram.

BELGIUM Etap Yachting, A J van Heygen. **DENMARK** Bianca Yachts, Coronet Boats, Faurby Yacht, Granada Yachts, L M Glasfiber, Luffe, Mascot Boats, Mön Boats, Nordborg Boats, Nordship, Walsted Boats, X-Yachts. **FINLAND** Artekno, Baltic Yachts, Bella, Botnia, Fingulf, Flipper, Tristan, Marin Form, Marino, Minor, Nautor's Swan, Sunwind, Nauticat, Nordic, Sirena, Tiiskeri. **FRANCE** A.C.M., A.M.E.L., Bénêteau, Catana, C.N. D'Aquitaine, C.N. Arlesien, Dufour, Eider Marine, Gibert Marine, Jeanneau, Kirié, Flash Boat, Locaboat, Nicol' Yacht, Ocqueteau, Plascoa, Stip, Tanguy, Wauquiez. **GREAT BRITAIN** Aqua star, Birchwood, Boating Scene, Broom, Cleopatra, Colvic, Cougar, Corvette Cruisers, Cruisers Int, Roger Clark, Falcon Sportboats, Fairline, Fletcher, Freedom Yachts, Hardy, Hunton Power Boats, Leisure Yachts Marine Projects, Moody, N B Yachts, Northshore, Pegasus, Prout Catamarans, Sadler, Sealine, Shetland Cruisers, Sigma, Silva Yates, Suncruiser, Sunseeker, Tremlett, Trident Marine, Victoria Marine, Westerly. **IRELAND** Darragh Boats. **ITALY** Abbate Bruno, Abbate Costruzioni Nautiche, Airon Marine Molinari, Alfa Marine, Alb Sail, Altura, Ambrosi, Azimut, Barberis, Benetti, Bianchi e Cecchi, Cantieri Di Baia, Cantiere Del Pardo, Catarsi, C & B Nautica, Cima, Cobra Marine, Colombo Giacomo, Comar, Comitti, Conam, Cosca, C.P.R., Cramar, Cranchi, Cranchi Cleto, Crestitalia, Dalla Pietà, Motomar Yachting, Della Pas-

qua e Carnevali, Eria Marine, Fiart, Franchini, Gagliotta, Gariplast, Giannetti, Giorgi, Gobbi-Hobby Craft, Giumma, Ilver, Italcraft, Italmare, Jet Craft, Marino, F. Ili Mileo, Mingo, Mochi Craft, Molinari Eugenio, Nuova Fiberglass, Nova Marine 2, Orion Palanca, Palomba, Partenautica, Patrone, Petteruti, F. Ili Piantoni, Plastimare, Power Boat Italia, Raffaelli, Ranieri, Rio, Ing Ruggero Vio Venezia, Savir, Scandinavian Motor Boats, Sciallino, Scotti, Sidra, Se Ri Gi, Solcio, Splash Marine, Squalo 2000, Teknocantieri, Tecnoyacht, Tripesce, Vele International, Vitalco, VZ, Zaniboni, Zippo. **NETHERLANDS** Aquanaut Yachting, Jachtwerf De Boarnstream, Conyplex, Hollandia, Kempers, Klaassen, Linssen-St Josef, Lowland Yachts, Meijer, Moonen, Nauta Boats, Neptunus, Pedro Boot, Polaris, Jachtwerf De Steven, Van Dam Nordia, Valk-Kruiser, Veha, Anne Wever, Victoria, Jachtwerf De Vrijbuitter. **NORWAY** Agder Boat, Ali-Craft, Biam Boats, Bowi Boats, Delta Plast, Draco, Elwaro, Enes Båt, Fjord Boat, Halco, Infra Boat, Jans Yachting, Joda Båtbyggeri, KMV Boat, Marex, Master Boat, Nidelv Boat, Nord West Båt, Nordan Båtbyggeri, Norline, Otto Plast, Polar Boat, Rana Båt, Saga Boat, Scand Boats, Selby, Selfa, Skarpnes Båter, Skibsplast, Skilsö Baatbyggeri, Sollux, Sunrise, Tresfjord Boats, Unique Boat, Viksund Båt, Wester, Windy Boats, Winrace. **SPAIN** Astafersa, Astilleros Del Mar, Astondoa, Belliure, Construcciones Navales de Mallorca,

Copino, Costa Mediterranea, Dracomar, Dresport, Ducauto, Fernandez, Ferrer Rosello, Gallart, Industrial North Wind, La-Ra-Ya, Majoni, Menorca, Nabilsa, Nidelv Boat, Olaziregui, Rodman, Swift Craft Española. **SWEDEN** Ansö, Arksunds Båtbyggeri, Boghammar, Bonum, Br Börjesson, Comfortbåtar, Cropier Båt, Fabola Marin, Forgusbåtar, Gecco, Gävle Marinteknik, Hallberg-Rassy, Hällers Båt, Kornhalls Varv, Lasallbåtar, Malö Yacht, Marieholm Boats, Najadvarvet, Nimbus Boats, Nimo Marin, Norum Marin, Ockelbo, Orrskär, Orustprodukt, Overseas 35, Parad, Pelle Pettersson, Pollux, Porali Marin, Rex Marin, Rocco Boats, Roslagsbåtar, Rosätra Båtvarv, Saltöbåtar, Smuggler, Storebro, Striker, Sweden Yacht, Swemax, Tollare Boat, Tortuna Båt, Two Star, Utterbåtar, Wasa Marin, Vindö Sweden, Västkuistsnipan, Öregrunds Båtvarv. **SWITZERLAND** Müller Yachtbau, Metallbau, Saphir, Pedrazzini, Schneider. **WEST GERMANY** Allround Bootsbau, Ancora Yachtwerft, Asmus Werft, Bavaria, Bützleflth, DD-Yachten, Dehler, Doriff, Fassmer-Werft, Fiberline, Hatecke, Henze-Bootswerft, Cytra-Werft, Hiltgergerke, Kammin, Kunya-Werft, Outborn Yachting, Pfeil Yachtbau, Schleswiger Werkstätten, Sirius Yachten, Schütz-Werke. **YUGOSLAVIA** Elan.

VOLVO PENTA

JOHS. THORNAM A/S, KALVEBOD BRYGGE 20,
1560 KØBENHAVN V. TLF.: 01 14 07 82.

RESULTATLISTE SJÆLLAND RUNDT 1988

4. START FREDAG 12:00 BANE 1 - GENNEM GRØNSUND

236 SØMIL

LØB 28 APHRODITE 101 (ENTYPE)

NR.	BÅDNAVN	TYPE	SEJLNR	BÅDENS FØRER	MÅL	ODDEN	AGERSØ	SKANSE	SALTH.	HELSINGØR	SEJLTID	POINTTID	PLAC	
429	KATJA	APH.101	D	255	KARL-ERIK JANSSON	7.10	L08:04	L13:32	L22:58	S03:15:30	39:15:30	41:16:43	PR 1	
428	GUFFE	APH.101	D	135	FLEMMING DANIEL PETERSEN	7.10		L14:36	S00:00	S04:32:32	40:32:32	42:33:45	PR 2	
434	NAM NAM	APH.101	D	335	STEEN HVIID/HANSEN	7.10	L00:02	L14:49	S00:08	S04:51:27	40:51:27	42:52:40	PR 3	
431	LOLITA	APH.101	D	308	IB FRITZBØGER	7.10	L00:02	L14:37	S00:08	S04:54:44	40:54:44	42:55:57	4	
433	HVID MAGI	APH.101	D	320	PETER BJERRUM	7.10	L00:36	L09:30	L15:06	S00:23	S04:58:58	40:58:58	43:00:11	5
425	LADY MONDO	APH.101	D	48	NILS OVERGÅRD	7.10	L08:45	L15:31		S06:48:27	42:48:27	44:49:40	6	
427	MAJA	APH.101	D	125	KAARE SLOTH	7.10	L00:02	L09:40	L15:18		S07:15:40	43:15:40	45:16:53	7
430		APH.101	D	304	C. E. BAKKE-JACOBSEN	7.10	L00:45	L10:00	L15:38		S07:18:32	43:18:32	45:19:45	8
424	TAI-TAI	APH.101	D	24	ERIK CHRISTENSEN	7.10	L23:47	L08:55	L14:34		S05:41:05	41:41:05	45:42:18+2	9
432	BRINKMANN-SHIP	APH.101	D	313	NIELS BRINKMANN	7.10							DISKVALIFICERET	
423	BIT	APH.101	D	1	ERIK TINGLEFF LARSEN	7.10							IKKE STARTET	
426	SEE YOU	APH.101	D	54	FINN NIELSEN	7.10							IKKE STARTET	
435	STROZZI	APH.101	D	358	STEFFEN GULMANN	7.10							IKKE STARTET	

LØB 29 BB.10M (STANDARD)

NR.	BÅDNAVN	TYPE	SEJLNR	BÅDENS FØRER	MÅL	ODDEN	AGERSØ	SKANSE	SALTH.	HELSINGØR	SEJLTID	POINTTID	PLAC
453	BONBON	BB.10M	D	78	HANS TOBIESEN	7.30	L07:21	L12:47	L22:13	S02:26:50	38:26:50	40:57:19	PR 1
444	SJUS	BB.10M	D	53	BJARNE S CLAUSEN	7.30	L07:30	L12:59	L22:25	S02:36:33	38:36:33	41:07:02	PR 2
451	MI MI	BB.10M	D	74	OLE OHLSEN	7.30	L07:36	L13:04	L22:26	S02:36:43	38:36:43	41:07:12	PR 3
447	JUSTITIA IV	BB.10M	D	63	MOGENS LARSEN	7.30	L07:26	L12:55	L22:26	S02:45:15	38:45:15	41:15:44	PR 4
438	MANANA	BB.10M	S	7	PETER RÖING	7.30	L08:01	L13:37	L22:55	S03:05:53	39:05:53	41:36:22	5
446	LOISE	BB.10M	D	60	JOHN DE HAAS	7.30		L13:48	L23:00	S03:11:55	39:11:55	41:42:24	6
440	SOPHIE	BB.10M	D	42	JESPER KONGSTAD	7.30	L08:08	L13:43		S03:34:23	39:34:23	42:04:52	7
437	MARISSE	BB.10M	D	7	CLAUS CHRISTIANSEN	7.30	L23:29	L08:25	L14:03	S03:46:12	39:46:12	42:16:41	8
436	KILROY	BB.10M	D	4	JOHANNES JOHANNESSEN	7.30	L08:40	L14:11	L23:35	S03:49:10	39:49:10	42:19:39	9
442	MAJ	BB.10M	D	46	STEEN UDSEN	7.30	L23:27	L14:07	L23:40	S04:00:21	40:00:21	42:30:50	10
449	TIBBE	BB.10M	D	70	PALLE SKYLDAL	7.30	L00:02	L14:34		S04:16:42	40:16:42	42:47:11	11
443	JOY	BB.10M	D	50	ARNE JØRGENSEN	7.30	L23:31	L08:37	L14:10	S04:20:52	40:20:52	42:51:21	12
450	IL TEMPO GIGANT	BB.10M	D	71	MICHAEL THAARUP	7.30	L00:02	L09:00	L14:42	S04:23:45	40:23:45	42:54:14	13
452	UMIAQ	BB.10M	D	79	J. EBBEHØJ	7.30	L00:02	L14:47	S00:05	S04:33:50	40:33:50	43:04:19	14
441	JO	BB.10M	D	44	JAN LETH	7.30		L14:37	S00:08	S04:58:08	40:58:08	43:28:37	15
448	FRØKEN UPS!	BB.10M	D	67	MARIANNE CARLSEN	7.30		L14:11		UDGÅET			
445	RR	BB.10M	D	57	JØRGEN RINGGAARD	7.30	L23:32	L13:57	L23:30				DISKVALIFICERET
439	KOLIBRI	BB.10M	D	11	LARS GAMMELTOFT	7.30							IKKE STARTET

LØB 30 SCANCAP 99 (STANDARD)

NR.	BÅDNAVN	TYPE	SEJLNR	BÅDENS FØRER	MÅL	ODDEN	AGERSØ	SKANSE	SALTH.	HELSINGØR	SEJLTID	POINTTID	PLAC	
455	KALINKA	SCAN.99	D	16	HENNING JACOBSEN	7.35		L13:22	L23:15	S03:24:27	39:24:27	42:02:03	PR 1	
467	ARRIVE	SCAN.99	D	105	LARS BRÅMER-JENSEN	7.35	L23:35	L08:30	L14:03	L23:17	S03:35:58	39:35:58	42:13:34	PR 2
456	CHARCRIS	SCAN.99	D	28	FINN HENRIKSEN	7.35	L08:23	L14:00	L23:36	S04:00:51	40:00:51	42:38:27	PR 3	
466	MADISON	SCAN.99	D	101	JØRGEN ELGAARD	7.35		L14:32	L23:50	S04:09:52	40:09:52	42:47:28	PR 4	
469	G	SCAN.99	D	121	JOHNNY STAMNESFEST	7.35	L23:45	L08:40	L14:18	L23:51	S04:12:40	40:12:40	42:50:16	5
465	SOFFY	SCAN.99	D	99	CARL AAGE JENSEN	7.35	L00:02	L08:55	L14:37	L23:55	S04:19:25	40:19:25	42:57:01	6
463	KAPSTAN	SCAN.99	D	80	OLE BRUUN	7.35	L00:02	L14:37	S00:00	S04:29:51	40:29:51	43:07:27	7	
462	SPAR ES	SCAN.99	D	79	JOHN R. HANSEN	7.35	L00:02	L14:42	S00:08	S04:35:25	40:35:25	43:13:01	8	
457	KIRCH	SCAN.99	D	36	FINN ANDERSEN	7.35	L23:50	L14:27	S00:11	S04:42:29	40:42:29	43:20:05	9	
458	ESPADA	SCAN.99	D	40	BERTIL RASMUSSEN	7.35	L09:40	L15:31		S06:11:34	42:11:34	44:49:10	10	
464	MR. PEANUT	SCAN.99	D	82	OLE BONDE LARSEN	7.35	F21:46	L09:50	L15:41	S06:48:14	42:48:14	45:25:50	11	
459	QUASIMODO	SCAN.99	D	45	BENT SCHARNBERG	7.35	L00:02	L09:40	L15:33	S01:00	S06:52:34	42:52:34	45:30:10	12
460	HOBOSKE	SCAN.99	D	51	JENS ERIK MELDGAARD	7.35	L00:02	L15:18		S06:58:36	42:58:36	45:36:12	13	
454	CON AMORE	SCAN.99	D	2	EJVIND KOEFOED	7.35	L00:45	L15:42		S07:35:32	43:35:32	46:13:08	14	
468	KIPPER	SCAN.99	D	111	JØRGEN LINTHOE	7.35		L15:51		S07:52:35	43:52:35	46:30:11	15	
461	TRIPPE	SCAN.99	D	62	KARL HILMER MADSEN	7.35	L02:05	L11:45	L17:20	S09:01:14	45:01:14	49:38:50+2	16	

LØB 31 INTERNATIONAL 1006

NR.	BÅDNAVN	TYPE	SEJLNR	BÅDENS FØRER	MÅL	ODDEN	AGERSØ	SKANSE	SALTH.	HELSINGØR	SEJLTID	POINTTID	PLAC	
473	LOTTE	I.1006	D	15	JAMES LAMMERT	6.90	L23:44	L08:37	L14:18	L23:50	S04:08:26	40:08:26	41:39:12	PR 1
477	CREME FRAICHE	I.1006	D	48	THERKILD NIELSEN	6.95		L08:42	L14:21	L23:45	S04:04:04	40:04:04	41:42:33	PR 2
470	SUPER MULE	I.1006	D	2	BJØRN JUNKER HANSEN	6.90	L00:02	L08:47	L14:22	L23:55	S04:19:10	40:19:10	41:49:56	3
474	KRABASK	I.1006	D	26	KAI THINGSIG	6.90	L00:02	L09:00	L14:42	S00:00	S04:22:22	40:22:22	41:53:08	4
476	STORMSKY	I.1006	D	45	JAN ERREBO	7.00	L23:55	L14:20	L23:47	S04:09:08	40:09:08	41:55:17	5	
475	PENELOPE	I.1006	D	29	EILER NIELSEN	6.95	L23:41	L14:34		S04:55:59	40:55:59	42:34:28	6	
471	JOCH II	I.1006	D	6	HENRIK MADSEN	7.00	L00:02	L09:05	L14:47	S00:31	S05:23:21	41:23:21	43:09:30	7
472	HEJREN	I.1006	D	13	ANN-LIS BUCHHORN	6.85	L00:02	L09:23	L15:10	S00:40	S05:54:37	41:54:37	43:17:34	8

RESULTATLISTE SJÆLLAND RUNDT 1988

4. START FREDAG 12:00 BANE 1 - GENNEM GRØNSUND

236 SØMIL

LØB 32 BANNER 34

NR.	BÅDNAVN	TYPE	SEJLNR	BÅDENS FØRER	MÅL	ODDEN	AGERSØ	SKANSE	SALTH.	HELINGØR	SEJLTID	POINTTID	PLAC	
485	Y	BAN.34	D	33	KÅRE ANDRESEN	7.15		L13:47		S03:41:18	39:41:18	41:49:57	PR 1	
482	KERMIT	BAN.34		20	ARNE ANDERSSON	7.15	L23:25	L08:23	L13:58	L23:30	S03:45:25	39:45:25	41:54:04	PR 2
478	TRUNTE	BAN.34	D	11	JAN CZUBA	7.20	L23:31	L08:22	L13:53	L23:16	S03:38:50	39:38:50	41:54:50	3
481	FIRE HOFF II	BAN.34	D	19	POUL J. PEDERSEN	7.15	L00:02		L14:37	L23:55	S04:13:07	40:13:07	42:21:46	4
479	HØNSETYVEN	BAN.34	D	15	PER KJØMPE	7.15	L23:50	L08:54	L14:35	L23:51	S04:19:52	40:19:52	42:28:31	5
483	CHESS	BAN.34	D	28	CHR WILLE	7.20	L23:55		L14:44	S00:11	S04:41:15	40:41:15	42:57:15	6
484	BANNER LINE	BAN.34	D	31	JAN GEORGI	7.15	L00:02	L09:35	L15:31		S06:43:59	42:43:59	44:52:38	7
480	IMMAQA	BAN.34	D	17	POUL JASZCZAK	7.05		L10:47	L16:42		S09:28:20	45:28:20	47:22:05	8

LØB 33 LARSEN 34 (STANDARD)

NR.	BÅDNAVN	TYPE	SEJLNR	BÅDENS FØRER	MÅL	ODDEN	AGERSØ	SKANSE	SALTH.	HELINGØR	SEJLTID	POINTTID	PLAC	
490	SNEHVIDE	LARS.34	D	23	ARNE LARSEN	7.25	L23:26	L08:25	L14:03	L23:36	S04:04:26	40:04:26	42:27:43	PR 1
487	LABOKIKI	LARS.34	D	11	BØJE NIELSEN	7.25		L08:23	L14:04	L23:43	S04:09:04	40:09:04	42:32:21	PR 2
489	FILUR	LARS.34	D	17	BRDR. ANDERSEN	7.25	L23:26	L08:22	L14:03	L23:38	S04:13:48	40:13:48	42:37:05	PR 3
496	KROKODILLEN	LARS.34	D	34	JESPER STRUCKMANN	7.25	L23:55		L14:27	L23:51	S04:17:51	40:17:51	42:41:08	4
498	SVANEN	LARS.34	D	58	OLE BØGH JENSEN	7.25	L23:55		L14:42	S00:17	S04:53:17	40:53:17	43:16:34	5
494	SCIROCCO	LARS.34	D	30	JACOB HEUCH	7.25	L23:55		L14:48		S05:48:12	41:48:12	44:11:29	6
488	THORS HAMMER	LARS.34	D	12	CLAES JENSEN	7.25	L00:45		L15:54		S07:52:55	43:52:55	46:16:12	7
495	LANGE MAREN	LARS.34	D	31	HENNING W BENGTTSSON	7.25	L01:10	L10:30	L16:20		S08:29:56	44:29:56	46:53:13	8
491	VALIUM	LARS.34	D	25	HENNING THOMSEN	7.25			L15:28		S06:42:56	42:42:56	47:06:13+2	9
492	SLIVOWIZ	LARS.34	D	27	BENT FREDERIKSEN	7.25	L00:02	L09:05	L14:51	S00:25	DISKVALIFICERET			
493	MOONLIGHT LADY	LARS.34	D	28	BO KOKHOLM	7.25					IKKE STARTET			

LØB 34 BANNER 30 (STANDARD)

NR.	BÅDNAVN	TYPE	SEJLNR	BÅDENS FØRER	MÅL	ODDEN	AGERSØ	SKANSE	SALTH.	HELINGØR	SEJLTID	POINTTID	PLAC	
502	RED LABEL	BAN30	D	22	TOM LØFSTRØM	7.00	L23:35	L08:45	L14:36	S00:08	S04:48:09	40:48:09	42:34:18	PR 1
507	LINE	BAN30	D	60	POVL NIELSEN	7.00	L00:02	L09:05	L14:53	S00:27	S05:25:41	41:25:41	43:11:50	PR 2
508	BEBS	BAN30	D	62	CARSTEN B NIELSEN	7.00	L23:49		L14:48	S00:25	S05:32:21	41:32:21	43:18:30	PR 3
506	QUICKSTEP	BAN30	D	57	BIRGER PRÆSTRUD	7.00	L00:02		L15:07		S06:44:26	42:44:26	44:30:35	4
510	WILD TING	BAN30	D	78	KURT LARSEN	7.00	L23:43		L14:53		S07:42:24	43:42:24	45:28:33	5
509	EASY	BAN30	D	64	BENT SØRENSEN	7.00	L00:02	L09:40	L15:47		S07:57:13	43:57:13	45:43:22	6
503	JAMUNA	BAN30	D	27	LEON AXELSEN	7.00	L00:45	L10:15	L16:27		S08:19:25	44:19:25	46:05:34	7
499	FLIPPER	BAN30	D	10	TAGE LANTZ	7.00	L00:36	L10:27	L16:28	S00:35	S08:33:29	44:33:29	46:19:38	8
501	BANNDITT	BAN30	D	14	CHR. BENTZEN	7.00		L10:05	L16:05		S08:56:00	44:56:00	46:42:09	9
505	BANDIT	BAN30	D	35	ERNST HØLZER	7.00	L00:45	L10:26	L16:41		S09:01:00	45:01:00	48:47:09+2	10
500	BANNEROUGE	BAN30	D	12	SØREN L. PETERSEN	7.00					IKKE STARTET			
504	BORA	BAN30		29	JOHANN FRIEDRICHSEN	7.00					IKKE STARTET			

RESULTATLISTE SJÆLLAND RUNDT 1988

4. START FREDAG 12:00 BANE 1 - GENNEM GRØNSUND

236 SØMIL

LØB 35 10M TYPER, DH 6.45 - 8.00

NR.	BÅDNAVN	TYPE	SEJLNR	BÅDENS FØRER	MÅL	ODDEN	AGERSØ	SKANSE	SALTH.	HELSINGØR	SEJLTID	POINTTID	PLAC	
486	SHARK	LARS.34	D	1	HANS LYKKE	7.10		L13:31	L22:50	S02:56:28	38:56:28	40:57:40	PR 1	
518	BITO MAX	COLI353	D	60	ERIK FRANSDEN	7.35	L07:36	L13:10	L22:44	S02:49:59	38:49:59	41:27:35	PR 2	
541	REBECCA	SOL.AL	D	31	SØREN HANSEN	7.00	L23:29	L08:19	L14:01	L23:25	S03:41:37	39:41:37	41:27:46	PR 3
527	VIVACE	KA.10M	D	37	STEFFEN BØLLUND	7.10	L23:25	L08:19	L13:53	L23:16	S03:28:43	39:28:43	41:29:56	PR 4
525	SARA	KA.10M	D	24	PETER SCHYTTE	7.10		L08:05	L13:21	L23:15	S03:33:26	39:33:26	41:34:38	PR 5
522	ISABELLE	F.C.10M	S	77	SVEN-ÅKE SVENSSON	7.95	F22:39	L07:18	L12:50	L21:59	S02:01:40	38:01:40	41:59:45	PR 6
523	VON KARMAN	KA.10M	D	5	SVEND VOGT ANDERSEN	7.10			L14:22	L23:43	S04:01:49	40:01:49	42:03:02	PR 7
526	KONG FUS	KA.10M	D	27	POUL-ERIK PETERSEN	7.10	L23:30		L14:04	L23:38	S04:04:53	40:04:53	42:06:06	8
511	EMANUELLE	ATHE.35	D	51	HARLEY JENSEN	7.30	L23:27		L14:04	L23:30	S03:44:10	39:44:10	42:14:39	9
521	BRODER TUCK	F.C.10M	S	10	JENS NIELSEN	7.95			L12:59	L22:18	S02:20:21	38:20:21	42:18:26	10
519	EVERGREEN III	EVER.32	D	2	KAI BAUM	7.25	L23:31	L08:28	L13:59	L23:51	S04:14:31	40:14:31	42:37:48	11
531	MOCCA	SAFIR	D	165	HENNING PEDERSEN	6.65	L23:40	L09:00	L14:52	S00:41	S05:47:37	41:47:37	42:38:28	12
537	PENET	SMA.34	D	40	ULRICH MAAGAARD	7.20	L23:28	L08:30	L14:21	S00:00	S04:26:10	40:26:10	42:42:10	13
532	DORTHEA	SAFIR	D	179	STIG S. ANDERSEN	6.45	L23:39		L14:51	S00:41	S06:29:08	42:29:08	42:46:28	14
512	CAN CAN	BAN30	D	1	TOMMI MADSEN	7.20	L23:40		L14:35	S00:05	S04:36:06	40:36:06	42:52:06	15
513	LADY DIANA	BOH10M	D	7	ERIK DAM HANSEN	7.60	L23:34	L07:44	L14:01	L23:25	S03:40:56	39:40:56	42:53:11	16
524	MALEIKA	KA.10M	D	6	GEO ØSTERGAARD	7.10	L00:02	L09:05	L14:52	S00:35	S06:12:56	42:12:56	44:14:09	17
534	RED DEVIL	SAFIR	D	210	ARNO HANSEN	6.65		L09:50	L15:52		S08:01:20	44:01:20	44:52:11	18
516	CAPRICCIO	CAPRIO	D	1	A EISENHARDT	6.60		L09:35	L15:30		S08:14:02	44:14:02	44:56:37	19
497	KILI	LARS.34	D	51	KIM MORTENSEN	6.85	L00:45		L15:52		S07:38:40	43:38:40	45:01:36	20
535	TAKE OFF	SCAN345		35	HARKELL/ HAVEDAL	7.40			L15:06		S06:30:15	42:30:15	45:14:56	21
533	CASSINA	SAFIR	D	202	CHRISTIAN THON	6.50	L01:10		L16:50		S09:03:12	45:03:12	45:29:02	22
540	NAVIGO	SOL.AL	D	30	JOHN GROTH	7.05	L23:45		L14:53		S07:44:31	43:44:31	45:38:16	23
539	TANJA II	SOL.AL	D	19	ARNE KRISTENSEN	6.90	L00:45		L16:00		S08:24:23	44:24:23	45:55:09	24
530	ROMAN	OPTI101		122	MICHAEL SCHLAGE	7.05	L00:36	L09:50	L15:41		S08:07:24	44:07:24	46:01:09	25
520	LADY B	F.C.10M	D	1	HARTVIG SASS JENSEN	8.00	L00:02		L14:55	S00:31	S06:07:30	42:07:30	46:11:52	26
536	SANA	SILVA35	D	4	NIELS-HENRIK THOMASEN	7.10	L00:54		L15:54		S08:32:50	44:32:50	46:34:03	27
517	PEIK III	COLI353	D	55	ERLING RASMUSSEN	7.30	L00:02	L10:26	L16:14		S08:10:06	44:10:06	46:40:35	28
538	GUTTE	SOL.AL	D	17	ARNE FREDERIKSEN	7.25	L01:40	L11:00	L16:56		S08:40:13	44:40:13	47:03:30	29
529	CACTUS	LOT.10M	D	7	OLE HOLCK	6.85		L12:05	L17:51		S10:32:37	46:32:37	47:55:34	30
528	MATILDE	LOT.10M	D	7	PELLE ANDERSEN NEXØ	6.85	L23:43		L15:49					DISKVALIFICERET
514	HAVSTRYGEREN	BOH10M	D	15	KELD DEICHMANN	7.40								IKKE STARTET
515	AURORA	BOH10M	D	16	CHARLOTTE FRIIS	7.40								IKKE STARTET

LØB 36 10M TYPER, DH 6.35 - 7.85

NR.	BÅDNAVN	TYPE	SEJLNR	BÅDENS FØRER	MÅL	ODDEN	AGERSØ	SKANSE	SALTH.	HELSINGØR	SEJLTID	POINTTID	PLAC	
544	FIFI	AVA36	D	30	TORBEN EISENSØE	7.10	L23:37	L08:23	L14:00	L23:30	S03:47:12	39:47:12	41:48:25	PR 1
542	AFRODITE	APH.34	S	41	LARS HAMMERØ	6.95		L09:23	L15:18	S01:00	S06:22:07	42:22:07	44:00:36	PR 2
543	LADY OF LARSMD	AVA36			JENS HØGEL	7.10	L00:02	L09:35	L15:17		S06:01:48	42:01:48	44:03:01	PR 3
558	MERIDIANA	H-35		8143	GUSSE MIRSCH	6.40	L00:36	L09:45	L15:47		S07:54:43	43:54:43	44:03:26	PR 4
551	CNRAMIA II	GAMB.35	S	6839	OLLE OLSSON	7.85		L08:01	L13:39		S04:21:16	40:21:16	44:06:34	5
546	ARIDA	AVA36	D	69	NIELS-JUEL JENSEN	7.05	L00:02	L09:35	L15:28		S06:39:59	42:39:59	44:33:44	6
556	CHAMPAGNEPROPP.	H-35	D	117	JES BIERING	6.75		L10:52	L16:40		S08:15:16	44:15:16	45:22:19	7
553	HEUREKA	H-323	D	10	PER BONDE	6.35	L01:50	L12:00	L17:39		S09:53:23	45:53:23	47:25:23	8
555	BOLETTE	H-35	D	102	POUL ERIK THOMSEN	6.80	L02:05	L11:40	L17:27		S09:29:10	45:29:10	46:44:12	9
559	HRINGHORNE	RHAP.34	S	22	CHRISTIAN BENNDORF	7.00	L01:30		F16:57		S09:28:47	45:28:47	47:14:56	10
554	GINTONIC	H-35	D		KIM FALKENBERG	6.80		L11:45	L17:27		S10:05:18	46:05:18	47:20:20	11
550	COMPROMISE	COMF34	D	243	LEIF SABRO	6.95		L08:01	L16:52		S09:46:35	45:46:35	47:25:04	12
545	SANINA	AVA36	D	39	LARS BENKERT	7.15	L01:30		F17:17		S10:06:50	46:06:50	48:15:29	13
552	PUELLA	GRA.35	D	55	JENS ANDERSEN	7.05	L00:54	L11:27	L17:30		S10:40:53	46:40:53	48:34:38	14
560	SPARTA	SLUP	G	2993	FRANZ HAMANN	6.70	L01:55	L12:20	L17:09		S12:01:58	48:01:58	49:00:58	15
557	VIOLA	H-35	D	119	OLE WINTHER	6.75			L17:09		S11:58:24	47:58:24	49:05:27	16
549	BASTA	CB 33	G	2	RAINER BIEBER	7.30	L00:02		L15:00	S00:41				DISKVALIFICERET

LØB 37 DEHLER 34 / 343

NR.	BÅDNAVN	TYPE	SEJLNR	BÅDENS FØRER	MÅL	ODDEN	AGERSØ	SKANSE	SALTH.	HELSINGØR	SEJLTID	POINTTID	PLAC	
567	NEW DEAL	DEHL343	D	461	PETER GRUM-SCHWENDSEN	7.05	L23:48	L08:54	L14:42	S00:23	S05:16:36	41:16:36	43:10:21	PR 1
398	JEHFA	DEH.DB	D	261	FRANK ELKJÆR	7.45		L08:12	L13:58		S04:23:09	40:23:09	43:14:48	PR 2
568	BETTY BLUE	DEHL343	D	476	ERIK ROESGAARD	7.00	L23:55	L09:05	L14:52	S00:35	S05:33:53	41:33:53	43:20:02	3
564	MOUSE	DEHL.34	D	162	KURT F. JAKOBSEN	7.40	L00:02		L15:12	S01:00	S06:23:17	42:23:17	45:07:58	4
562	MAHOUT	DEHL.34	D	272	HENRIK JØRGENSEN	7.10	L23:55	L09:30	L15:17	S01:05	S07:08:00	43:08:00	45:09:13	5
561	LYNET	DEHL.34	D	246	SØREN ARENTOFT	7.50	L00:02		L15:10		S06:17:04	42:17:04	45:15:40	6
563	SEASUN	DEHL.34	D	297	OLE ABEL	7.40	L00:02		L15:18		S07:01:48	43:01:48	45:46:29	7
566	NDOALA	DEHL343	D	389	GORM HELLES	7.05	L00:02	L09:40	L15:53		S08:33:53	44:33:53	46:27:38	8
565	TORDENSKJOLD	DEHL343	D	366	ARNE F LARSEN	6.85		L12:35	L17:14		S11:47:27	47:47:27	49:10:24	9

RESULTATLISTE SJÆLLAND RUNDT 1988

4. START FREDAG 12:00 BANE 1 - GENNEM GRØNSUND

236 SØMIL

LØB 38 MAXI 999

NR.	BÅDNAVN	TYPE	SEJLNR	BÅDENS	FØRER	MÅL	ODDEN	AGERSØ	SKANSE	SALTH.	HELSEINGØR	SEJLTID	POINTTID	PLAC
573	AMIA	MAXI999	D	159	E. WEBER	OLESEN	6.95	L23:48	L08:54	L14:35	S04:25:45	40:25:45	42:04:14	PR 1
572	GØJE	MAXI999	D	131	KLAUS M. JENSEN		6.95	L00:02		L15:06	S06:38:10	42:38:10	44:16:39	PR 2
569	VAGUS	MAXI999	D	40	JENS PETER NIELSEN		6.90	L00:02	L09:30	L15:38	S07:29:16	43:29:16	45:00:02	3
570	TALISMAN	MAXI999	D	45	FINN SØNDERGAARD		6.95	L00:36		L14:54	S07:45:11	43:45:11	45:23:40	4
571	CHRISTINA	MAXI999		78	JAN CHRISTOFFERSSON		6.90			L15:53	S07:59:24	43:59:24	45:30:10	5
575	TORTUGA II	MAXI999	D	294	MICHAEL DAVIDSEN		7.00		L10:50	L16:43	S08:33:56	44:33:56	46:20:05	6
574	SMJT	MAXI999	D	276	BENT BJERRING		6.90	L00:45	L10:47	L16:47	S09:12:48	45:12:48	46:43:34	7

RESULTATLISTE SJÆLLAND RUNDT 1988

5. START FREDAG 12:30 BANE 1 - GENNEM GRØNSUND

236 SØMIL

LØB 40 COMF 32 / N. FAM.

NR.	BÅDNAVN	TYPE	SEJLNR	BÅDENS FØRER	MÅL	ODDEN	AGERSØ	SKANSE	SALTH.	HELINGØR	SEJLTID	POINTTID	PLAC
584	RAPP	N.FAM.	D 32	BENNY ANDERSEN	6.55		L09:55	L15:32		S06:28:45	41:58:45	43:27:26	PR 1
577	EMILIA	COMF32	S 87	JAN MOLIN	6.60			L16:43		S08:21:48	43:51:48	45:28:47	PR 2
578	INCH BY WINCH	COMF32	S 353	BJARNE R. NILSSON	6.60			F17:07		S09:19:19	44:49:19	46:26:18	3
581	DINO	N.FAM.	D 10	TYGE BRUUN	6.45	L02:15		L17:41		S10:09:30	45:39:30	46:51:14	4
586	BLUE SHADOW	N.FAM.	S 318	ULF NILSSON	6.35	L02:50		L18:03		S10:40:38	46:10:38	47:05:01	5
582	FATA MORGANA	N.FAM.	D 19	ANDERS KRISTENSEN	6.45			L17:46		S12:28:05	47:58:05	49:09:49	6
576	PODICEPS	COMF32	G 34	JENS PRAMANN	6.70	L00:02		L18:51		S13:29:23	48:59:23	50:52:46	7
585	MAGDA	N.FAM.	D 45	JENS SØRENSEN	6.50	L02:15	L12:50	L18:50		S14:05:28	49:35:28	50:55:42	8
583	SNEJEGASTEN	N.FAM.	D 28	HELGE PREUTHUN	6.45	L07:12		S04:10	S20:40	M02:49:22	62:19:22	63:31:06	9
579	MRS. C	COMF32	S 383	LARS KLITTE	6.60	L00:36							IKKE STARTET

LØB 41 GRANADA 31

NR.	BÅDNAVN	TYPE	SEJLNR	BÅDENS FØRER	MÅL	ODDEN	AGERSØ	SKANSE	SALTH.	HELINGØR	SEJLTID	POINTTID	PLAC
593	AMANDA	GRAN31	D 309	LARS-E. SANDSTRØM	6.55		L10:37	L16:35		S09:07:11	44:37:11	46:05:52	PR 1
588	CHARLOTTE	GRAN31	D 10	HENRIK BRASK	6.40	L01:10	L11:12	F16:58		S09:38:05	45:08:05	46:11:12	PR 2
589	LIBITTA	GRAN31	D 45	TOLF ASKLER	6.55	L02:05	L12:30	L17:08		S11:04:57	46:34:57	48:03:38	3
592	ITEA	GRAN31	G 202	DITTMER FRANZ	6.55	L02:15	L12:50	L17:41		S12:27:57	47:57:57	49:26:38	4
587	BLAST	GRAN31	D 1	JØRGEN BALLIEU	6.50	L01:25		L17:48		S12:43:51	48:13:51	49:34:05	5
591	AFRODITE	GRAN31	D 79	KURT RASMUSSEN	6.60		L13:20	L19:02		S14:01:15	49:31:15	51:08:14	6
590	OLIVIA	GRAN31	D 67	BIRGER BROSBØL-JENSEN	6.45	L04:15	L07:44	L20:22	S07:05	S14:51:50	50:21:50	51:33:34	7

LØB 42 COMFORTINA 32 (STANDARD)

NR.	BÅDNAVN	TYPE	SEJLNR	BÅDENS FØRER	MÅL	ODDEN	AGERSØ	SKANSE	SALTH.	HELINGØR	SEJLTID	POINTTID	PLAC
595	COMTESSE	COMF32	D 249	NIELS ANTHONISEN	6.60	L01:15	L10:50	L16:44	S02:32	S08:39:59	44:09:59	45:46:58	PR 1
603	JAMA	COMF32	D 520	CARSTEN SVENDSEN	6.60		L10:44	L16:35		S08:46:22	44:16:22	45:53:21	PR 2
596	SVECA	COMF32	D 316	BJARNE CARLSEN	6.60			L16:39		S08:46:48	44:16:48	45:53:47	PR 3
600	FREJA	COMF32	D 480	MOGENS HANSEN	6.60	L01:15	L10:54	L16:43	S02:35	S08:48:39	44:18:39	45:55:38	4
580	MERINO	COMF32	G 603	FRED SCHÄFER	6.60		L10:59	L16:46		S08:49:41	44:19:41	45:56:40	5
601	SUN	COMF32	D 495	TORBEN CHRISTIANSEN	6.60	L00:45	L10:46	L16:36	S02:35	S09:02:34	44:32:34	46:09:33	6
598	NANOK	COMF32	D 386	STEN AAGESEN	6.60	L01:05	L10:56	L16:50		S09:14:07	44:44:07	46:21:06	7
597	DIPSO	COMF32	D 385	BENT WENSKE PEDERSEN	6.60	L01:50	L11:35	L17:22		S10:01:14	45:31:14	47:08:13	8
594	MANANA II	COMF32	D 244	KELD BELTNER	6.60	L01:50	L11:45	L17:35	S01:05	S10:34:48	46:04:48	47:41:47	9
599	SCHANWADU	COMF32	D 453	ERIK KLEIST	6.60			L17:31		S13:16:17	48:46:17	50:23:16	10
604	STEP INN	COMF32	D 614	BENT BORCH-CHRISTENSEN	6.60	L02:30	L13:08	L19:00	S02:08	S13:28:29	48:58:29	50:35:28	11
602	TRILLE	COMF32	D 507	HANS WOLF	6.60	L02:30	L13:16	L19:09	S06:17	S13:44:10	49:14:10	50:51:09	12

LØB 43 ALBIN NOVA

NR.	BÅDNAVN	TYPE	SEJLNR	BÅDENS FØRER	MÅL	ODDEN	AGERSØ	SKANSE	SALTH.	HELINGØR	SEJLTID	POINTTID	PLAC
607	DIDDE	ALB.NOV	D 210	SVEN BETAK	6.85	L01:50	L11:12	L16:46		S08:14:50	43:44:50	46:02:11	PR 1
614	SUSSI	ALB.NOV	D 293	KNUD E SKØTT	6.85	L01:05		L16:36		S08:23:13	43:53:13	46:10:34	PR 2
612	OPHELIA	ALB.NOV	D 275	IB LINGS	6.90		L11:10	L16:55		S08:23:30	43:53:30	46:18:40	PR 3
616	JAMAS	ALB.NOV	D 352	LASSE JOHANSEN	6.85		L11:26	F16:59		S08:52:14	44:22:14	46:39:35	4
610	LI	ALB.NOV	D 250	BORIS LINDVALL	7.05	L01:40	L10:57	L16:40		S08:26:11	43:56:11	46:44:20	5
619	ATALANTE	ALB.NOV	D 369	VOLSGAARD/BØVING	6.70	L01:55	L11:35	L17:22		S09:26:07	44:56:07	46:49:30	6
606	OLIVIA	ALB.NOV	D 201	JØRGEN FLEMMER	6.70	L02:10	L12:13	L17:47		S09:47:30	45:17:30	47:10:53	7
615	NIKOLINE	ALB.NOV	D 343	JOHN THELLERSEN	6.90	L02:15	L12:00	L17:39		S09:15:54	44:45:54	47:11:04	8
617	SPECIAL	ALB.NOV	D 361	JAN LARSEN	7.15	L02:00	L11:55	L17:27		S09:27:47	44:57:47	48:00:50	9
613	FLEUR II	ALB.NOV	D 276	JENS K NIELSEN	6.75	L03:35	L14:06	L19:31		S10:49:21	46:19:21	48:20:48	10
605	NOVAJA	ALB.NOV	D 10	SØREN SVOLGART	6.80	L02:45	L13:00	L17:35		S11:15:13	46:45:13	48:54:39	11
609	ZANCLUS	ALB.NOV	D 236	L. PFEIFFER	6.90	L02:10				S12:22:27	47:52:27	50:17:37	12
611	SANNE	ALB.NOV	D 264	KURT SPARWATH	6.45		L13:20	L19:41		S13:36:20	49:06:20	50:18:04	13
608	MALENE	ALB.NOV	D 214	POUL SKYTTE	6.95	L02:25	L12:15	L17:50		S10:59:51	46:29:51	51:02:44+2	14
618	KIVI II	ALB.NOV	D 368	KIM NIELSEN	6.80	L02:30	L13:05	L19:28	S06:35	S14:44:12	50:14:12	52:23:38	15

RESULTATLISTE SJÆLLAND RUNDT 1988

5. START FREDAG 12:30 BANE 1 - GENNEM GRØNSUND

236 SØMIL

LØB 44 LARSEN 28

NR.	BÅDNAVN	TYPE	SEJLNR	BÅDENS FØRER	MÅL	ODDEN	AGERSØ	SKANSE	SALTH.	HELSEINGØR	SEJLTID	POINTTID	PLAC
629	SECOND WIFE	LARS.28 D	50	SØREN NYBO	6.50	L01:10	L10:30	L16:21		S07:57:48	43:27:48	44:48:02	PR 1
628	SOLA	LARS.28 D	43	STEFFEN STEFFENSEN	6.50	L01:10	L10:37	L16:32		S08:07:02	43:37:02	44:57:16	PR 2
621	CARL OSCAR	LARS.28 D	3	STEEN JÖNSSON	6.50	L00:54	L10:30	L16:27		S08:09:34	43:39:34	44:59:48	PR 3
627	1ER CRU	LARS.28 D	35	HORSKJÆR/CAPPELEN	6.50		L10:15	L16:16	S01:45	S08:16:22	43:46:22	45:06:36	4
630	OFF PIST	LARS.28 D	63	BENT ERIK JENSEN	6.50	L00:45	L10:10	L16:18		S08:31:10	44:01:10	45:21:24	5
624	MESSALINA	LARS.28 D	21	BJARNE ANDERSEN	6.35	L01:55	L11:40	L17:25		S09:37:02	45:07:02	46:01:25	6
626	GRABHØVEN	LARS.28 D	34	JØRGEN VILLUMSEN	6.50	L01:50		L17:41		S09:46:50	45:16:50	46:37:04	7
622	DUO	LARS.28 D	14	C. RUDE/ T. LYNGENBO	6.50	L02:10		L17:47		S10:26:13	45:56:13	47:16:27	8
620	FOX	LARS.28 D	2	PER MIKKELSEN	6.50		L13:20	L19:36	S06:30	S13:35:10	49:05:10	50:25:24	9
623	SKJALM HVIDE	LARS.28 D	15	JØRGEN SCHRØDER	6.50	L01:19		L16:45		DISKVALIFICERET			
625	APPELMUST	LARS.28 D	28	ULRICH BOESEN	6.50					IKKE STARTET			

LØB 45 OMEGA 30

NR.	BÅDNAVN	TYPE	SEJLNR	BÅDENS FØRER	MÅL	ODDEN	AGERSØ	SKANSE	SALTH.	HELSEINGØR	SEJLTID	POINTTID	PLAC
638	SIF	OMG.30 D	214	KURT NIELSEN	6.75	L01:05		L16:03		S07:58:53	43:28:53	45:30:20	PR 1
639	FRIGG	OMG.30 D	237	PER BASLAND	6.75	L00:45	L10:10	L15:54		S08:02:20	43:32:20	45:33:47	PR 2
641	ROSE-MARIE	OMG.30 D	263	TURE ANDERBERG	6.80	L01:05		L16:36		S08:15:37	43:45:37	45:55:03	PR 3
633	JAMBI	OMG.30 S	77	INGVAR ANDERSSON	6.75	L01:19	L11:05	L16:48		S08:38:54	44:08:54	46:10:21	4
634	SCHUZZ	OMG.30 D	101	POUL ERIK LORENTZEN	6.75		L11:25	F17:02		S09:00:05	44:30:05	46:31:32	5
631	ALOHA	OMG.30 D	7	HERMAN RANSBORG	6.80	L02:05	L12:00	L17:30		S08:58:52	44:28:52	46:38:18	6
637	MY STYLE	OMG.30 D	159	JESPER THEMSEN	6.85	L01:30	L11:14	F16:57		S09:03:27	44:33:27	46:50:48	7
640	MADAM MUGS	OMG.30 D	239	JØRGEN NYBRØE	6.60	L01:50		L17:29		S10:07:09	45:37:09	47:14:08	8
642	PNYX	OMG.30 D	276	HENRIK TESCH	6.80	L01:40	L11:17	F17:02		S09:40:02	45:10:02	47:19:28	9
635	MIHO	OMG.30 D	111	GUNNAR TERMENSEN	6.70		L11:45	L17:27		S09:56:23	45:26:23	47:19:46	10
632	FORCE	OMG.30 S	50	BENGT DENCKERT	6.80		L11:21	F17:01		S09:43:36	45:13:36	47:23:02	11
636	PULS	OMG.30 S	135	BERTH BJERNETUN	6.75					IKKE STARTET			

LØB 46 DH 6.15 - 7.25

NR.	BÅDNAVN	TYPE	SEJLNR	BÅDENS FØRER	MÅL	ODDEN	AGERSØ	SKANSE	SALTH.	HELSEINGØR	SEJLTID	POINTTID	PLAC
653	TRO-AN	OMG.34 D	235	KAJ LARSEN	7.25	L00:02		L14:47	S00:08	S04:38:56	40:08:56	43:26:37	PR 1
652	JUBILEE	OMG.34 S	17	BØRJE NILSSON	7.20		L09:35	L15:17	S00:31	S05:25:01	40:55:01	44:05:25	PR 2
650	LØFFE	OLS.31 D	18	SØREN LØFTGAARD	6.50	L01:50	L11:19	L16:55	S02:32	S08:48:26	44:18:26	45:38:40	PR 3
645	HALF + HALF	HELMSE D	126	VAGN OLESEN	6.15	L02:10	L12:15	L17:54		S10:40:25	46:10:25	46:28:58	4
656	SVIMSE	OMG.34 D	326	FREDDY ANDERSEN	7.00		L11:05	L16:44		S08:23:05	43:53:05	46:33:38	5
655	COLLECTION	OMG.34 D	307	PER WADSKJÆR	7.15	L00:45		L15:43		S08:03:45	43:33:45	46:36:48	6
647	ENJOY	OLS.31 D	11	ERIK WINTHER	6.55			L17:39		S10:01:52	45:31:52	47:00:33	7
646	FRK OLSEN	OLS.31 D	2	JØRGEN MEINERTZ	6.50	L02:05	L12:00	L17:39		S10:10:26	45:40:26	47:00:40	8
649	TAM TAM	OLS.31 D	17	FLEMMING CHRISTENSEN	6.50	L02:30	L12:25	L18:05		S10:33:20	46:03:20	47:23:34	9
654	HAVBART	OMG.34 D	247	JØRGEN KRAMPAU	7.05	L02:45		L17:14		S10:33:28	46:03:28	48:51:37	10
648	DONAWAY	OLS.31 D	12	HENNING SZTUK	6.45	L02:15	L12:15	L17:51		S10:33:19	46:03:19	49:15:03+2	11
643	MISS	HELMSE	48	KARL MÖLLER	6.15			L19:08		S13:39:53	49:09:53	49:28:26	12
651	PARESE	OLS.31 D	41	ANKER PETERSEN	6.55	L02:00	L12:20	L17:54		S10:38:17	46:08:17	49:36:58+2	13
644	LA CONCUBINA	HELMSE D	96	OLE VIDSTRUP	6.30	L03:15		L20:40	S08:00	S15:06:56	50:36:56	51:22:31	14

RESULTATLISTE SJÆLLAND RUNDT 1988

5. START FREDAG 12:30 BANE 1 - GENNEM GRØNSUND

236 SØMIL

LØB 47 DH 5.90 - 10.00

NR.	BÅDNAVN	TYPE	SEJLNR	BÅDENS FØRER	MÅL	ODDEN	AGERSØ	SKANSE	SALTH.	HELINGØR	SEJLTID	POINTTID	PLAC	
661	BEDSTE	BRØK.30	D	1	HENRIK BRØKER	6.80		L08:47	L14:42	L23:55	S04:16:10	39:46:10	41:55:36	PR 1
664	MOJN-MOJN	CONT.33	D	198	JØRGEN HEMPEL	6.85	L00:02	L09:23	L15:10		S05:29:58	40:59:58	43:17:19	PR 2
669	FEDTMULE	FINN.F	D	1089	KURT JENSEN	6.85	L00:45	L09:55	L15:33		S06:37:14	42:07:14	44:24:35	PR 3
668	OPHELIA	DRA.33	D	100	NIELS J. JENSEN	6.25	L00:54		L16:28		S08:27:50	43:57:50	44:34:31	PR 4
688	AYESHA V	SAG.35	G	2534	H. ROTERMUND	6.45	L01:19	L10:50	L16:40	S02:23	S08:32:10	44:02:10	45:13:54	PR 5
682	VIBEN	NORL34	D	737	VIGGO NYBORG	7.05		L09:45	L15:30		S07:15:01	42:45:01	45:33:10	PR 6
677	SWING	MAMBA33	D	61	PETER SIMONSEN	6.55	L01:08	L10:52	L16:45		S08:41:25	44:11:25	45:40:06	PR 7
659	PELIKAN	BAND35	D	4	GLENN BENTZEN	6.75	L00:45	L12:45	L15:53		S08:19:14	43:49:14	45:50:41	8
667	AIOLOS	DRA.33	D	25	ERIK LAURIDSEN	6.85	L01:15	L10:05	L15:56		S08:14:58	43:44:58	46:02:19	9
685	PILI 4	SAG.35	D	268	JOHN UNO JENSEN	6.80	L01:05	L10:44	L16:28		S08:33:05	44:03:05	46:12:31	10
686	STORDING	SAG.35	D	271	POVL VIKANES	6.85	L00:36	L09:55	L15:55		S08:31:24	44:01:24	46:18:45	11
666	CONQUISTADOR	DOMI.95		7964	SVEND FLOOD	7.15		L10:37	L15:55		S07:51:58	43:21:58	46:25:01	12
663	RIKKE RASK	CONT.33	D	156	KOCH/SVENDSTRUP	6.90		L10:26	L16:18		S08:45:09	44:15:09	46:40:19	13
684	GLASULLA	SAG.35	D	36	GUNNAR LANGKILDE	6.75	L01:05	L11:13	F17:01		S09:30:49	45:00:49	47:02:16	14
683	RED BLAZE	RB 93	S	10	HEINZ MÖLLER	6.80		L11:28	F17:14		S09:40:05	45:10:05	47:19:31	15
676	DIKTAT	MAMBA33	D	58	BO LEVISEN	6.80	L01:55	L11:45	L17:27	S06:17	S09:40:50	45:10:50	47:20:16	16
660	DINA II	BAND35	D	18	KENT NØRGAARD	7.40	L00:45	L10:05	L15:55		S08:14:22	43:44:22	47:23:27	17
665	PALAARSUAQ	CONT.33	D	202	OVE DAMGAARD KRISTENSEN	6.95		L11:50			S09:29:38	44:59:38	47:32:31	18
658	H & M	BAND35	D	3	KNUD GEORG KLEBERG	6.85	L01:50	L11:40	L17:27		S09:46:41	45:16:41	47:34:02	19
548	AMBER	BIA.36	D	370	THORKILD KRISTENSEN	6.85		L11:50	L17:39		S10:00:34	45:30:34	47:47:55	20
689	CINQADUS	ZULEIKA	S	5	JØRGEN BOOK	6.65	L02:30		L17:10		S10:38:23	46:08:23	47:53:38	21
547	CRUISADER	BIA.36	D	333	MICHAEL FRIIS	6.90	L00:45	L10:27	L16:25		S08:31:11	44:01:11	48:26:21+2	22
678	NUNA	MAMBA33	D	61	JOHN BRENDSTRUP LARSEN	6.50		L10:15	L17:11		S13:02:56	48:32:56	49:53:10	23
675	ANDERS AND	K.CR33	D	458	ALEKS JØRGENSEN	6.35		L13:37	L19:34	S06:42	S14:03:04	49:33:04	50:27:27	24
672	PAW IV	K.CR33	D	134	FINN KALLEDSØE	6.40	L02:30	L13:20	L19:09		S13:58:02	49:28:02	50:31:09	25
674	LISBETH	K.CR33	D	172	PETER MANDEL	6.40	L03:20	L14:49	L20:26	S08:34	S16:09:19	51:39:19	52:42:26	26
673	UNDINE III	K.CR33	D	145	NILS LOU	6.15	L07:38		S04:32		M07:02:24	66:32:24	66:50:57	27
671	JAMBO	K.CR33	D	60	JØRGEN LARSEN	6.05					UDGÅET			
1162	NIKE	ALUB31	D	1025	JACOB FREDERIKSEN	6.50	L00:02	L09:30	L15:23	S00:55	DISKVALIFICERET			
670	SAPHIR	FRIE.35	G	3345	HELMUT WORSTORFF	6.85	L00:02				DISKVALIFICERET			
679	SCAN-KET	MAXI33			LASSE QUIST	10.00	L03:00	L14:07	L19:42		DISKVALIFICERET			
681	SIRIO	MAXI33	D	717	BENNY SILAS JENSEN	10.00	L05:39	L17:22	L23:05	S15:50	DISKVALIFICERET			
657	CELESTIN	ALLEG33	S	64	BENGT PAULSSON	10.00					IKKE STARTET			
687	CAMILLA	SAG.35	D	509	KNUD KÆSTEL	6.80					IKKE STARTET			

LØB 48 THURØ 33

NR.	BÅDNAVN	TYPE	SEJLNR	BÅDENS FØRER	MÅL	ODDEN	AGERSØ	SKANSE	SALTH.	HELINGØR	SEJLTID	POINTTID	PLAC	
695	ARN-GRY	THU.33	D	1109	NIELS CHR. ARNESEN	6.60	L00:36		L15:55		S08:13:14	43:43:14	45:20:13	PR 1
694	KARINA	THU.33	D	1106	FRANK HANSEN	6.55	L02:10	L10:26	L16:26		S08:30:46	44:00:46	45:29:27	PR 2
696	RASMINE	THU.33	D	1099	FL. FROST NIELSEN	6.50		L11:28	F17:17		S10:17:53	45:47:53	47:08:07	3
690	JOU JOU II	THU.33	D	353	NILS ELLEGÅRD RASMUSSEN	6.65	L01:45	L12:00	L17:47		S10:28:26	45:58:26	47:43:41	4
693	LUNKE	THU.33	D	1090	JØRGEN WIENBERG	6.55	L02:30	L13:20	L18:00		S10:48:19	46:18:19	47:47:00	5
692	CAROLINE	THU.33	D	967	GERT SAABY	6.45	L01:45	L10:59	L16:47		DISKVALIFICERET			
691	JOHANNE	THU.33	D	745	SØREN LOTZ	6.65					IKKE STARTET			

LØB 49 COMPIS 33

NR.	BÅDNAVN	TYPE	SEJLNR	BÅDENS FØRER	MÅL	ODDEN	AGERSØ	SKANSE	SALTH.	HELINGØR	SEJLTID	POINTTID	PLAC	
703	BLÅHALS	COMP.33	D	111	BØRGE HANSEN	6.80	L00:45	L09:55	L15:57		S07:14:03	42:44:03	44:53:29	PR 1
700	TESLA	COMP.33	D	56	JØRGEN NØHR	6.80	L01:10	L10:25	L16:18	S01:45	S08:18:33	43:48:33	45:57:59	PR 2
701	ASUJA	COMP.33	D	104	H. MÜTZE / L. JACOBSEN	6.85	L01:46	L11:12	F16:59		S08:33:46	44:03:46	46:21:07	3
697	TIGERDYRET	COMP.33	D	40	PETER ROMER	6.55		L11:26	L17:29		S09:51:31	45:21:31	46:50:12	4
702	HELLE	COMP.33	D	110	ERIK GINNERUP-NIELSEN	6.75		L11:35	L17:29		S09:49:22	45:19:22	47:20:49	5
698	KAARE II	COMP.33	D	46	BENT PEDERSEN	6.80		L13:00			S11:19:47	46:49:47	48:59:13	6
704	FOLLOW ME	COMP.33	D	114	RALF GRIMSEHL	6.85	L02:15	L12:35	L17:08		S11:52:29	47:22:29	49:39:50	7
662	ANJA	COMP.33	D	63	EVAN DYRAN	6.75	L01:30	L12:05	L18:53	S01:05	S13:26:46	48:56:46	50:58:13	8
699	VIMSE	COMP.33	D	50	GERT LÖFVALL	6.55	L00:45	L12:50	L19:26	S06:17	S14:06:02	49:36:02	51:04:43	9

DANA PLUS

Serier af marineinstrumenter, der kan kobles sammen...

DANAMAX

- En ny elektronisk repeater med 50 mm LCD.
Monteres på f.eks. mast eller ruftag.
Betjenes fra cockpitet.
Utroligt lavt strømforbrug.

DANA 1100
Log, udsættes som
præmie til hurtigste
båd i hver start
værdi kr. 2.185,00

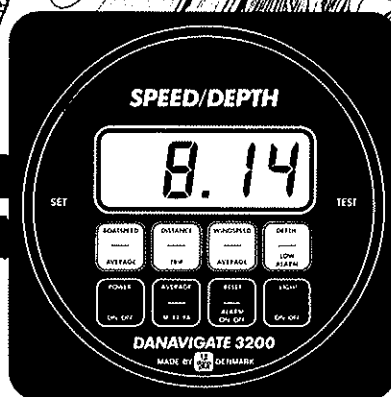

DANA 3000

En meget omfattende serie af marineinstrumenter med utrolige udvidelsesmuligheder. Alle instrumenterne har standardiseret databus udgang. I 3000 serien findes bl.a. fartmåler, ekkolod, vindcomputer, kompas og repeater til navigatoren. DANA 3000 er den perfekte basisserie i installationer, hvor DANA 1000 og 2000 instrumenter anvendes som repeatere. Kombinationsmulighederne kan opfylde den enkelte sejlers specielle informationsbehov.



DANA 1000

En ny serie af digitale miniinstrumenter (126 mm x 63 mm). Ingen betjeningsknapper. I serien findes bl.a. fartmåler, ekkolod, vindsystem og kompas. Nøjagtige informationer enten som individuelle instrumenter eller som data-repeatere for DANA 3000 serien. Attraktive og til en fordelagtig pris.

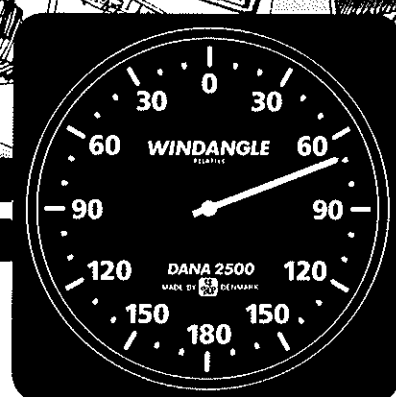

DANA 2000

En ny serie flade viserinstrumenter. En komplet instrumentserie, som samtidigt kan fungere som data-repeater for DANA 3000 serien. Samme instrumenthus og enkle montering som DANA 3000 serien. 360 grader rotation af viserne i alle instrumenterne giver maximal opløsning og nøjagtig udlæsning. Ingen trykknapper og automatisk regulering af den interne belysning.

dana plus

Ny udvidet garanti med "Danaplug Club"...

DANAPLUS · Ved Klædebo 12 · 2970 Hørsholm
Tlf.: 02 86 82 89 · Telex 37425 DAPLUS DK · FAX 02 86 70 77

10 års
erfaring i
avanceret
marineelektronik



RESULTATLISTE SJÆLLAND RUNDT 1988

6. START FREDAG 13:00 BANE 2 - GENNEM BØGESTRØMMEN

215 SOMIL

LØB 51 SPÆKHUGGER (STANDARD)

NR.	BÅDNAVN	TYPE	SEJLNR	BÅDENS FØRER	MÅL	ODDEN	AGERSØ	KALVEH	SALTH.	HELSEINGØR	SEJLTID	POINTTID	PLAC
712	KNUDSEN	SPÆKHUG D	65	PEDER SKOGSTAD	6.05	L02:25	L12:30	L18:25		S08:13:59	43:13:59	44:16:30	PR 1
709	RACY	SPÆKHUG D	31	GERT FABRICIUS	6.05		L12:42	L18:35	S02:08	S08:15:39	43:15:39	44:18:10	PR 2
747	TROJKA	SPÆKHUG	256	HANNE SKOVBJERG	6.05		L12:45	L18:40		S08:24:40	43:24:40	44:27:11	PR 3
716	JAMN-JAMN	SPÆKHUG D	75	SØREN MICHELSEN	6.05	L02:15	L12:30	L18:25		S08:29:24	43:29:24	44:31:55	PR 4
732	RAMID	SPÆKHUG D	142	IB SCHNEIDER	6.05	L02:15	L12:30	L18:25		S08:30:03	43:30:03	44:32:34	PR 5
706	GLAMMER	SPÆKHUG D	6	G RØNBY PEDERSEN	6.05	L02:10	L12:35	L18:40		S08:46:17	43:46:17	44:48:48	PR 6
743	BLÅ	SPÆKHUG D	215	JOHS. FOERSOM	6.05			L19:00	S02:32	S08:48:44	43:48:44	44:51:15	PR 7
730	NAUJA	SPÆKHUG D	133	JENS LILLEGAARD	6.05		L13:00	L19:05		S08:49:09	43:49:09	44:51:40	PR 8
708	TATAMOBØMA	SPÆKHUG D	24	DOT LOEHR	6.05	L02:25		L18:55	S02:35	S08:51:59	43:51:59	44:54:30	PR 9
741	ALABANØR	SPÆKHUG D	210	MARIANNE PETERSEN	6.05	L02:45	L13:16	L19:11	S02:40	S08:55:21	43:55:21	44:57:52	PR 10
721	NELLY	SPÆKHUG D	95	JENS HENRIKSEN	6.05			L19:05		S09:02:01	44:02:01	45:04:32	PR 11
745	SJØELGEN	SPÆKHUG S	241	SVEN SJØBERG	6.05	L02:30	L13:00	L19:05		S09:03:45	44:03:45	45:06:16	PR 12
757	ØJESTEN	SPÆKHUG D	310	STEN BROGAARD	6.05	L03:45		L19:00	S02:45	S09:09:37	44:09:37	45:12:08	PR 13
710	RIMFAXE	SPÆKHUG D	32	MOGENS HAUSCHULTZ	6.05	L02:40		L19:25		S09:09:54	44:09:54	45:12:25	PR 14
713	TJALFE	SPÆKHUG D	72	AAGE BOJSEN-MØLLER	6.05	L02:57		L19:20		S09:26:31	44:26:31	45:29:02	15
736	DILLE II	SPÆKHUG D	168	PREBEN H NIELSEN	6.05	L02:55	L13:33	L19:25		S09:27:12	44:27:12	45:29:43	16
722	PENELOPE	SPÆKHUG D	98	MARIANNE G. SOMMER	6.05	L02:45		L19:25		S09:39:09	44:39:09	45:41:40	17
756	PALE RIDER	SPÆKHUG D	300	THORUP/ KROGSGAARD	6.05	L02:45		L19:20		S09:39:53	44:39:53	45:42:24	18
739	PUSLING II	SPÆKHUG D	201	ARNE LAURSEN	6.05		L13:20	L19:20		S09:43:08	44:43:08	45:45:39	19
733	BONA FIDE	SPÆKHUG D	150	KIM LAU HANSEN	6.05		L13:41	L19:50		S09:49:59	44:49:59	45:52:30	20
753	HAVEJE	SPÆKHUG D	293	JØRGEN ØLLGAARD	6.05	L03:00	L14:03	L19:55		S09:52:40	44:52:40	45:55:11	21
748	BALANUS	SPÆKHUG D	257	KNUD WENDELBOE	6.05	L03:00	L14:06	L19:55		S09:54:05	44:54:05	45:56:36	22
761	RØDE ORM	SPÆKHUG D	422	FLEMMING BITZ	6.05		L13:42	L19:40		S09:56:05	44:56:05	45:58:36	23
717	HVALFISKEN	SPÆKHUG D	77	HANS HENNING ERIKSEN	6.05	L03:20	L14:20	L20:10		S10:14:15	45:14:15	46:16:46	24
719	ANTARES	SPÆKHUG D	81	HENRIK HENRIKSEN	6.05	L03:00		L19:45		S10:14:32	45:14:32	46:17:03	25
718	THOR	SPÆKHUG D	78	JENS PETER SANDHOLT	6.05	L02:57	L14:06	L19:55		S10:15:34	45:15:34	46:18:05	26
725	CAVU	SPÆKHUG D	101	ANDERS CLAUSEN	6.05	L02:45	L14:05	L20:05		S10:22:52	45:22:52	46:25:23	27
737	CARAMBA II	SPÆKHUG D	177	KIM NEIDEL	6.05	L03:15	L14:23	L20:20		S10:23:43	45:23:43	46:26:14	28
746	SPÆKULINE	SPÆKHUG D	252	PER GREGERSEN	6.05		L14:18	L20:15		S10:31:25	45:31:25	46:33:56	29
769	DAPHNE	SPÆKHUG D	501	FLEMMING BORGE	6.05	L03:10	L14:12	L20:10		S10:33:14	45:33:14	46:35:45	30
731	VIXEN	SPÆKHUG D	136	RUDI HASSE SJØBERG	6.05	L02:55	L14:02	L19:55		S10:33:21	45:33:21	46:35:52	31
751	BLACK JACK	SPÆKHUG D	268	SØREN VISNEK	6.05		L14:47	L20:30		S10:34:45	45:34:45	46:37:16	32
728	DILLE	SPÆKHUG D	125	LARS LUND	6.05	L02:50	L13:47	L20:00		S10:36:42	45:36:42	46:39:13	33
750	RØDØJE	SPÆKHUG D	263	BRØDRENE RASMUSSEN	6.05	L03:20	L14:23	L20:15		S10:39:33	45:39:33	46:42:04	34
744	MUSEN	SPÆKHUG D	240	BRUNO KLOKHØJ PEDERSEN	6.05		L14:19	L20:15		S10:39:41	45:39:41	46:42:12	35
766	BONA FIDE	SPÆKHUG D	469	BO SØRENSEN	6.05	L03:25	L14:34	L20:20		S10:41:40	45:41:40	46:44:11	36
711	ORCINUS ORCA	SPÆKHUG D	64	ERLAND MARKERT	6.05		L14:35	L20:20		S10:42:54	45:42:54	46:45:25	37
742	NAUSIKAA	SPÆKHUG D	212	KLAUS BARFOED	6.05	L03:30	L14:38	L20:20		S10:44:41	45:44:41	46:47:12	38
726	KARIN	SPÆKHUG D	103	MOGENS BERING LARSEN	6.05	L03:15	L14:25	L20:20		S10:52:58	45:52:58	46:55:29	39
723	MORTEN	SPÆKHUG D	99	JENS K. MORTENSEN	6.05	L02:15	L12:35	L18:35		S08:53:57	43:53:57	46:56:28+2	40
762	SNØVSEN	SPÆKHUG D	440	BJARNE JOHANSEN	6.05		L14:45	L20:35		S11:01:20	46:01:20	47:03:51	41
754	MAGDA	SPÆKHUG D	296	JOHN BÆCH	6.05	L03:40	L14:49	L20:05		S11:09:25	46:09:25	47:11:56	42
752	ALETA	SPÆKHUG D	286	CARSTEN BUGGE LARSEN	6.05	L03:25	L14:52	L20:40		S11:25:09	46:25:09	47:27:40	43
729	BIFROST	SPÆKHUG D	128	PETER HANSEN	6.05	L03:25	L14:48	L20:35		S11:25:53	46:25:53	47:28:24	44
770	SALLY	SPÆKHUG D	503	MOGENS PETERSSEN	6.05	L03:10	L14:27	L20:55		S11:26:24	46:26:24	47:28:55	45
740	ORCA	SPÆKHUG S	203	OTTO VON FRIESEN	6.05	L03:45	L14:58	L20:50		S11:43:36	46:43:36	47:46:07	46
760	KLUMPEN	SPÆKHUG D	361	IVAN BENTZEN	6.05	L03:30	L14:49	L20:35		S11:48:37	46:48:37	47:51:08	47
771	SØREN SPÆKKE	SPÆKHUG D	525	HENRI HERON/S. GRØNLUND	6.05	L03:35		L20:50		S11:50:13	46:50:13	47:52:44	48
705	BIMMER	SPÆKHUG D	314	FINN CHRISTIANSEN	6.05		L15:30	L21:10		S12:05:31	47:05:31	48:08:02	49
759	ANNE IV	SPÆKHUG D	318	OLE SØRENSEN	6.05	L03:20	L14:15			S10:15:30	45:15:30	48:18:01+2	50
715	SPAS	SPÆKHUG D	74	SVEND AAGE LARSEN	6.05	L03:45	L15:10	L21:00	S02:40	S12:17:32	47:17:32	48:20:03	51
735	NATASCHA	SPÆKHUG D	159	PETER DUE	6.05	L02:55	L13:47	L21:45		S13:05:55	48:05:55	49:08:26	52
720	MARGRETHE	SPÆKHUG D	86	MOGENS AALBORG	6.05	L04:15	L15:39	L21:30		S13:08:57	48:08:57	49:11:28	53
734	HAVGASSEN	SPÆKHUG D	151	JAN DURUP JØRGENSEN	6.05	L02:40	L15:42	L21:20		S13:22:49	48:22:49	49:25:20	54
767	FREJA	SPÆKHUG D	472	KAREN MARIE LYG	6.05	L04:19	L15:42	L21:35		S13:48:23	48:48:23	49:50:54	55
768	TILIA	SPÆKHUG D	478	OVE LIND	6.05	L04:10	L15:42	L21:45	S06:30	S14:24:40	49:24:40	50:27:11	56
727	ANCILLA	SPÆKHUG D	112	J. MADSEN & H. LUND	6.05		L15:01	L20:50		S12:29:03	47:29:03	50:31:34+2	57
765	SINUS	SPÆKHUG D	463	CARSTEN PETERSEN	6.05	L04:44	L16:25	L22:05	S11:45	S20:50:51	55:50:51	56:53:22	58
714	JONATHAN	SPÆKHUG D	73	OTTO PAULSEN	6.05	L03:10	L14:38			UDGÆT			
724	ELLA	SPÆKHUG D	100	KAI F. LANGKJÆR	6.05	L03:30	L14:58	L21:25		DISKVALIFICERET			
764	JEPPI	SPÆKHUG D	453	IB NIELSEN	6.05	L02:30		L19:20		DISKVALIFICERET			
707	HAJO	SPÆKHUG D	13	SONJA RASMUSSEN	6.05					IKKE STARTET			
738	KRINGLE	SPÆKHUG D	196	JAN KOFOD LARSEN	6.05					IKKE STARTET			
749	LUMA	SPÆKHUG D	260	MARTIN SHIELBO	6.05					IKKE STARTET			
755	SGUB	SPÆKHUG D	292	LARS NYBROE	6.05					IKKE STARTET			
758	GENIUS	SPÆKHUG D	313	ANDERS ESKILDSEN	6.05					IKKE STARTET			
763	DAGMAR	SPÆKHUG D	441	PALLE JØRSBOE	6.05					IKKE STARTET			

PRÆMIE-AFHENTNING

Jeg ønsker at afhente min præmie i perioden fra mandag den 29. august 1988 til torsdag den 1. september 1988, begge dage incl.

Kontorets åbningstider:

Mandag og tirsdag kl. 11.00 til 14.00

Onsdag og torsdag kl. 14.00 til 18.00

Denne blanket skal være sejlklubben i hænde senest den 5. august 1988.

Adresse: Helsingør Amatør Sejlklub
Strandpromenaden 6
3000 Helsingør



AFHENTNING AF PRÆMIE SJÆLLAND RUNDT 1988

Deltagernr.: _____ Løbsnr.: _____ Bådnavn: _____

Dato: _____

Underskrift: _____

Velkommen
i land...

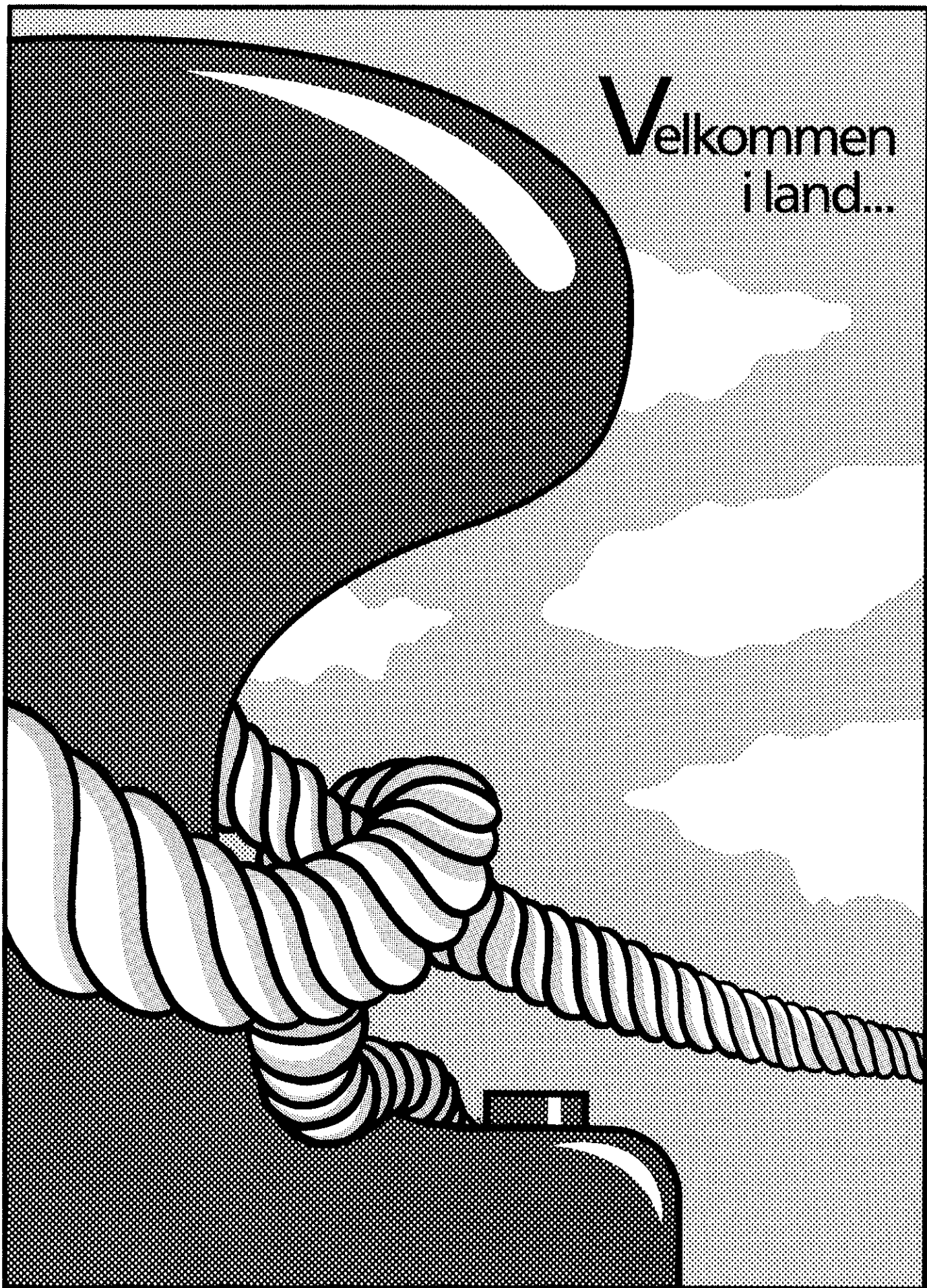

BOANDERSEN

NOKIA DATA

Hovedsponsor for Sjælland Rundt 1988

MANDSKABSGLAS



Bådnavn: _____

Deltagernummer: _____

Jeg bestiller hermed _____ stk.
mandskabsglas med Sjælland Rundt
1988 logo.

Prisen er 90,- pr. stk.
incl. forsendelse.

Jeg vedlægger crosset check på beløbet, check nr. _____

Navn: _____

Adresse: _____

Postadresse: _____

Underskrift: _____

RESULTATLISTE SJÆLLAND RUNDT 1988

6. START FREDAG 13:00 BANE 2 - GENNEM BØGESTRØMMEN

215 SØMIL

LØB 52 H-BÅD (ENTYPE)

NR.	BÅDNAVN	TYPE	SEJLNR	BÅDENS FØRER	MÅL	ODDEN	AGERSØ	KALVEH	SALTH.	HELSEINGØR	SEJLTID	POINTTID	PLAC
792	KURT	H-BÅD	D 368	SØREN MATHIASSEN	5.70	L01:50	L12:00	L17:55		S08:09:46	43:09:46	43:09:46	PR 1
781	MICCO	H-BÅD	D 151	KØRNER/HANSEN	5.70	L01:55		L18:00		S08:10:46	43:10:46	43:10:46	PR 2
800	MISS TAKE	H-BÅD	D 421	LARS LANGBALLE	5.70	L01:55	L12:00	L18:05		S08:13:37	43:13:37	43:13:37	PR 3
785	AMALIE	H-BÅD	D 251	LEIF BILSLEV-JENSEN	5.70	L02:20	L12:30	L18:30		S08:21:44	43:21:44	43:21:44	PR 4
793	XANTIPPE	H-BÅD	D 379	KURT IBSEN	5.70			L19:05		S09:00:39	44:00:39	44:00:39	PR 5
795	VENSYSSEL	H-BÅD	D 385	HENNING KRISTENSEN	5.70	L02:10	L12:45	L19:00	S02:40	S09:05:04	44:05:04	44:05:04	PR 6
782	SPARE TIME	H-BÅD	D 214	CARSTEN AAGAARD	5.70	L02:57		L19:20		S09:07:37	44:07:37	44:07:37	PR 7
789	SOL OG VIND	H-BÅD	D 288	JØRGEN JENSEN	5.70	L02:30	L13:08	L19:11		S09:07:55	44:07:55	44:07:55	8
783	GØGEREDEN	H-BÅD	D 224	MICHAEL WONTERGAEM	5.70		L13:25	L19:20		S09:09:19	44:09:19	44:09:19	9
796	COR	H-BÅD	D 405	POUL ERIK SCHWARTZLOSE	5.70		L13:40	L19:50		S09:43:31	44:43:31	44:43:31	10
801	AHT	H-BÅD	D 422	PEDER PILGAARD	5.70	L02:30		L19:11		S09:43:41	44:43:41	44:43:41	11
798	CATHRINE	H-BÅD	D 412	PETER A ANDERSEN	5.70	L02:57	L12:55	L19:05		S09:50:30	44:50:30	44:50:30	12
802	HVID MAGI	H-BÅD	D 450	HENNING F NØRREGAARD	5.70	L02:45		L19:50		S09:59:08	44:59:08	44:59:08	13
787	BUTTERFLY	H-BÅD	D 270	PETER ANKERSTJERNE	5.70		L14:02	L20:05		S10:10:32	45:10:32	45:10:32	14
799	AFGRUNDEN	H-BÅD	D 420	TOMMY RASMUSSEN	5.70	L03:25		L20:15		S10:13:45	45:13:45	45:13:45	15
794		H-BÅD	D 384	ALETTE BRÜEL	5.70	L03:00	L14:06	L20:05		S10:15:09	45:15:09	45:15:09	16
773	BIRGITTE	H-BÅD	D 11	JENS-FREDRIK NIELSEN	5.70	L03:00	L13:54	L19:55		S10:18:28	45:18:28	45:18:28	17
803	LA MOUSTACHE	H-BÅD	S 481	BJØRN HEGELUND	5.70	L03:10		L20:20		S10:34:36	45:34:36	45:34:36	18
776	PERNILLE	H-BÅD	D 88	LISBETH AA. JOHANSEN	5.70	L03:30	L14:42	L20:35		S11:16:25	46:16:25	46:16:25	19
791	QUERLING	H-BÅD	D 355	DENNIS S OLESEN	5.70	L03:00	L14:22	L20:20		S11:26:34	46:26:34	46:26:34	20
780	MOMO	H-BÅD	D 143	NIELS MARKUSSEN	5.70	L03:25	L14:34	L19:05		S11:36:11	46:36:11	46:36:11	21
790	HAPS	H-BÅD	D 344	PETER V. HANSEN	5.70	L03:20		L20:55		S11:38:29	46:38:29	46:38:29	22
772	SIF	H-BÅD	D 6	TINE P. BROCKHUUS	5.70	L03:35	L15:08	L21:00		S11:53:35	46:53:35	46:53:35	23
784	CHIP	H-BÅD	D 225	JENS HEIBERG	5.70	L03:55	L15:06	L19:11		S11:53:51	46:53:51	46:53:51	24
777	H	H-BÅD	D 92	OLE KRONGAARD	5.70	L04:05	L15:22	L21:05		S12:50:29	47:50:29	47:50:29	25
788	SJUSSEN	H-BÅD	D 281	STEN CHRISTENSEN	5.70	L04:36	L15:50	L21:25		S13:00:10	48:00:10	48:00:10	26
775	KATRINE	H-BÅD	D 63	JOHN SØRENSEN	5.70			L21:10		S13:10:09	48:10:09	48:10:09	27
786	RUBI	H-BÅD	D 260	FAXØE LARSEN	5.70					UDGÅET			
774	THYBALT	H-BÅD	D 47	BJØRN LASSEN	5.70					IKKE STARTET			
778	QUADRO	H-BÅD	D 98	JØRGEN PEDERSEN	5.70					IKKE STARTET			
779	SPRINGEVEN	H-BÅD	D 127	BIRGER CHRISTENSEN	5.70					IKKE STARTET			
797	BLUE MOON	H-BÅD	S 409	RONNY ANDERSSON	5.70					IKKE STARTET			
1775	HEREKATT	H-BÅD	G 3000	CHR. SCHERNIKAU	5.70					IKKE STARTET			

RESULTATLISTE SJÆLLAND RUNDT 1988

6. START FREDAG 13:00 BANE 2 - GENNEM BØGESTRØMMEN

215 SØMIL

LØB 53 X-79 (STANDARD)

NR.	BÅDNAVN	TYPE	SEJLNR	BÅDENS FØRER	MÅL	ODDEN	AGERSØ	KALVEH	SALTH.	HELSEINGØR	SEJLTID	POINTTID	PLAC
852		X-79	D 376	HANS ERIK ANDERSEN	6.50		L10:29	L16:10	L23:20	S03:44:24	38:44:24	41:00:01	PR 1
810	X-WIFE	X-79	D 94	TOM STENGADE	6.50	L01:05		L16:10	L23:20	S03:46:49	38:46:49	41:02:26	PR 2
864	X-CHANGE	X-79	D 421	FINN JEPPESEN	6.50	L01:15		L16:28	L23:45	S04:16:49	39:16:49	41:32:26	PR 3
863	GIRO	X-79	D 413	MARTIN MAJHOLT	6.50	L01:05	L10:30	L16:25	L23:50	S04:20:41	39:20:41	41:36:18	PR 4
842	MOSQUITO	X-79	D 310	CLAUS BRUUN	6.50		L12:55	L16:36	S00:00	S04:26:18	39:26:18	41:41:55	PR 5
807	ODD FISH	X-79	D 46	PETER FREDERIKSEN	6.50	L01:40	L11:00	L16:36		S04:28:46	39:28:46	41:44:23	PR 6
836	LES JUMEAUX	X-79	D 275	HENRIK LINDE	6.50	L01:05	L10:30	L16:22	L23:47	S04:31:12	39:31:12	41:46:49	PR 7
817	VAKSE VIGGO	X-79	D 192	GARHUSEN / SKARSTEEN	6.50	L01:19	L10:47	L16:36	S00:00	S04:32:15	39:32:15	41:47:52	PR 8
850	ROHRBRUCH	X-79	G 371	HEINER WILCKEN	6.50	L01:08	L10:37	L16:30	S00:00	S04:34:52	39:34:52	41:50:29	PR 9
847	SEXTANTEN	X-79	D 340	BRDR. BLØND	6.50		L11:05	L16:45	S00:05	S04:37:27	39:37:27	41:53:04	PR 10
825	TUSNELDA	X-79	D 233	JOHN MUUSHARDT	6.50	L01:19	L10:47	L16:36	S00:05	S04:39:58	39:39:58	41:55:35	PR 11
849	X-KÆRESTEN	X-79	D 346	NILS BJERREGÅRD	6.50		L10:58	L16:45	S00:05	S04:40:05	39:40:05	41:55:42	PR 12
858	CO-X	X-79	D 400	ESKESEN/ RIBER/FREDERIKSE	6.50	L01:40	L11:21	L17:00	S00:11	S04:49:59	39:49:59	42:05:36	PR 13
819	SURE'X	X-79	D 211	JAN MADSEN	6.50	L01:45	L11:10	L16:55	S00:15	S04:50:01	39:50:01	42:05:38	14
829	EXMERALDA	X-79	D 247	DAN NILSSON	6.50	L01:25	L11:04	L16:50	S00:05	S04:50:21	39:50:21	42:05:58	15
853	XANTIPPE	X-79	D 392	KIM HESS LARSEN	6.50	L01:19	L10:50	L16:36	S00:05	S05:00:29	40:00:29	42:16:06	16
813	CHAROLE	X-79	D 173	CHARLES L PEDERSEN	6.50	L01:25	L11:02	L16:50	S00:15	S05:02:29	40:02:29	42:18:06	17
821	MON FIANCE	X-79	D 220	STEEN TØNNES	6.50	L01:55	L11:35	L17:15	S00:23	S05:20:17	40:20:17	42:35:54	18
1776	PENDUL-ROTTEN	X-79	D 148	CHR. JENSEN	6.50	L01:55			M04:45	S05:49:06	40:49:06	43:04:43	19
832	KRYDS	X-79	D 251	NIELS TRANBERG	6.50	L02:10	L11:50	L17:35	S00:41	S06:08:05	41:08:05	43:23:42	20
840	EASY RIDER	X-79	D 301	JAN BISP	6.50		L11:28	L17:15	S00:35	S06:12:13	41:12:13	43:27:50	21
862	XIELLE	X-79	D 410	HENNING GÖTZSCHE	6.50		L11:28	L17:15	S00:35	S06:14:24	41:14:24	43:30:01	22
843	X-7-9-13	X-79	D 315	STEEN JAKOBSEN	6.50	L02:05	L11:55	L17:40	S01:00	S06:18:09	41:18:09	43:33:46	23
834	FOXTROT	X-79	D 260	LAUSTSEN/RASMUSSEN	6.50	L02:10	L11:50	L17:35	S00:41	S06:18:37	41:18:37	43:34:14	24
1773	N.N.	X-79	D 219	JESPER HJORTH	6.50			L17:40	S00:55	S06:24:07	41:24:07	43:39:44	25
805	SKRIG OG SKRÅL	X-79	D 28	BIRGER CHR. CHRISTENSEN	6.50		L11:45	L17:35	S00:05	S06:41:23	41:41:23	43:57:00	26
827	X-PRESSO	X-79	D 238	JOHN PINGEL	6.50	L02:10		L17:35	S00:48	S06:49:25	41:49:25	44:05:02	27
815	BARE X'ET	X-79	D 182	JENS KNUDSEN	6.50		L12:05	L17:40	S01:00	S07:02:59	42:02:59	44:18:36	28
859	QUARTERBACK	X-79	D 403	HENRIK JØRGENSEN	6.50	L01:55	L11:55	L17:40		S07:09:11	42:09:11	44:24:48	29
860	STYX	X-79	D 404	CLAUS BJØRKE	6.50	L02:15	L12:13	L17:55		S07:10:16	42:10:16	44:25:53	30
823	HEY-YOU	X-79	D 230	STEEN WEBER	6.50	L02:15	L12:13	L17:55		S07:16:50	42:16:50	44:32:27	31
808	RAGTIME	X-79	D 50	JESPER KJÆR PEDERSEN	6.50	L02:10	L12:10	L17:50		S07:19:33	42:19:33	44:35:10	32
854	XAYAR	X-79	D 396	TOMMY THOMSEN	6.50	L02:30	L12:20	L18:00		S07:21:53	42:21:53	44:37:30	33
820	KLØR KNÆGT	X-79	D 212	MICHAEL WOHLGEMUTH	6.50	L02:25	L12:13	L17:55		S07:37:20	42:37:20	44:52:57	34
861	HOTLIPS	X-79	D 405	ROBERT H HANSEN	6.50	L01:55		L17:50		S07:49:24	42:49:24	45:01:01	35
833	THE UNFORGETTAB	X-79	D 255	SØRENSEN/NIELSEN	6.50	L01:55		L17:50		S07:49:33	42:49:33	45:05:10	36
855	KOX	X-79	D 397	KIM HEILMANN	6.50	L02:30	L12:25	L18:10		S07:52:50	42:52:50	45:08:27	37
816	HOTBOXEN	X-79	D 183	ERIK HANSEN	6.50	L02:30	L12:25	L18:10		S07:56:16	42:56:16	45:11:53	38
831	BREDFLAB	X-79	D 249	JACOB HOLM	6.50	L02:15	L12:13	L17:55		S08:02:47	43:02:47	45:18:24	39
814	HVORF'DET	X-79	D 176	STEEN GRUNDTVIG	6.50	L01:50		L17:40		S08:04:04	43:04:04	45:19:41	40
841	SNURRETOPPEN	X-79	D 306	THEIS JØRGENSEN	6.50	L02:15	L12:30	L18:25	S01:55	S08:05:58	43:05:58	45:21:35	41
845	MATELOT	X-79	D 318	JAN STRØMVG	6.50		L12:45	L18:30		S08:06:15	43:06:15	45:21:52	42
812	EXODUS	X-79	D 135	MICHAEL JØRGENSEN	6.50			L18:50		S08:19:29	43:19:29	45:35:06	43
806	NECESSE	X-79	D 32	SØREN RAHBEK	6.50	L02:25	L08:05	L18:05		S08:21:17	43:21:17	45:36:54	44
851	XANTHOS	X-79	D 374	HENNING MOOSMANN	6.50	L01:50	L12:13	L18:00		S08:23:16	43:23:16	45:38:53	45
811	PROMILLE	X-79	S 123	STEFAN MÖLLER	6.50	L02:40	L12:45	L18:40		S08:25:31	43:25:31	45:41:08	46
839	X'EREN	X-79	D 299	LEIF FRANDSEN	6.50	L02:15		L18:25		S08:28:28	43:28:28	45:44:05	47
835	SLAP A'	X-79	D 263	HENRIK SCHNOOR HANSEN	6.50	L01:55	L12:25	L18:15		S08:28:37	43:28:37	45:44:14	48
809	MALIK	X-79	D 65	E. FAVSBORG	6.50	L02:45				S08:29:38	43:29:38	45:45:15	49
818	HEXEN	X-79	D 207	PHILIP AALUND	6.50	L02:20		L18:45		S08:33:23	43:33:23	45:49:00	50
848	BLÅ MAGI	X-79	D 345	PETER HØJ HANSEN	6.50	L02:25		L19:00		S08:35:55	43:35:55	45:51:32	51
804	SPEXER	X-79	S 6	LESLIE SPENNER	6.50	L02:35		L19:11		S08:49:51	43:49:51	46:05:28	52
826	ELVIS	X-79	D 236	SENGELØV/NIELSEN	6.50			L19:20	S02:45	S08:56:29	43:56:29	46:12:06	53
824	CARMEN ROSITA	X-79	D 232	HANS HEMMINGSEN	6.50	L02:30	L13:00	L19:00	S02:23	S08:57:35	43:57:35	46:13:12	54
838	LILLE ÅGE	X-79	D 292	JESPER ARENTOFT	6.50	L00:36	L09:50	L15:33	L22:58	DISKVALIFICERET			
856	H.C. GÖTZSCHE	X-79	D 398	CLAUS B. JENSEN	6.50	L01:05		L16:17	L23:30	DISKVALIFICERET			
865	FAXE KONDI	X-79	D 427	DAN LINDQUIST PETERSEN	6.50	L01:19		L16:30	L23:40	DISKVALIFICERET			
844	BETTE SWAN	X-79	D 316	PETER F. JENSEN	6.50		L11:40	L17:35		DISKVALIFICERET			
830	EXO GAMY	X-79	D 248	MADS KLAUSEN	6.50	L02:05		L17:55		DISKVALIFICERET			
822	HELT X'ET	X-79	D 221	FRANK NIELSEN	6.50					IKKE STARTET			
828	HEXEHYL	X-79	D 240	JENS HALDAGER	6.50					IKKE STARTET			
837	FEDEST	X-79	D 277	ANDERS LINNET	6.50					IKKE STARTET			
846	EXCESS	X-79	G 323	RÜDIGER STEVEN	6.50					IKKE STARTET			
857	RANDOM WAHL	X-79	D 399	MARGIT ANDERSEN	6.50					IKKE STARTET			

RESULTATLISTE SJÆLLAND RUNDT 1988

7. START FREDAG 13:30 BANE 2 - GENNEM BØGESTRØMMEN

215 SØMIL

LØB 55 ALBIN ALPHA

NR.	BÅDNAVN	TYPE	SEJLNR	BÅDENS FØRER	MÅL	ODDEN	AGERSØ	KALVEH	SALTH.	HELSEINGØR	SEJLTID	POINTTID	PLAC
869	ALPHINA	ALB.ALP D	89	BJARNE H HANSEN	6.40		L12:25	L18:10		S08:03:29	42:33:29	45:31:40	PR 1
867	NAOMI	ALB.ALP D	41	STIG SVENSSON	6.40	L02:30	L12:50	L19:00		S08:28:42	42:58:42	45:56:53	PR 2
870	REVANCHE	ALB.ALP D	101	JAN NISBETH	6.45	L02:57		L19:05		S08:49:47	43:19:47	46:25:49	PR 3
875	WEBELINE	ALB.ALP D	147	JØRGEN WEBER	6.40	L03:00	L13:45	L19:35		S09:08:25	43:38:25	46:36:36	4
877	FRU JENSEN	ALB.ALP D	159	NIELS JENSEN	6.55	L03:00	L13:28	L19:11		S08:58:44	43:28:44	46:50:13	5
871	AQUA	ALB.ALP D	120	BJØRN SIBBERN	6.35	L03:00	L13:41	L19:35		S09:41:06	44:11:06	47:01:20	6
876	VILLIMOS	ALB.ALP D	154	HANS JAKOBSEN	6.50	L03:00	L16:05	L19:15		S09:39:46	44:09:46	47:23:33	7
874	AMANDA	ALB.ALP D	144	OLE BANG	6.45	L02:45		L20:15		S10:12:39	44:42:39	47:48:41	8
872	SOFIE	ALB.ALP D	121	PREBEN SØEGAARD	6.50	L03:40	L14:40	L20:35		S10:46:21	45:16:21	48:30:08	9
873	CHIRMI	ALB.ALP D	138	KNUD BONKE	6.35	L03:45	L14:52	L20:35		S11:21:23	45:51:23	48:41:37	10
866	SWING	ALB.ALP D	27	OLE KAMPMANN-LASSEN	6.50	L04:15	L15:30	L21:35		S12:52:29	47:22:29	50:36:16	11
868	HVALBORG	ALB.ALP D	47	LEIF PEDERSEN	6.40	L02:57				UDGÅET			

LØB 56 INTERNATIONAL 806 (STANDARD)

NR.	BÅDNAVN	TYPE	SEJLNR	BÅDENS FØRER	MÅL	ODDEN	AGERSØ	KALVEH	SALTH.	HELSEINGØR	SEJLTID	POINTTID	PLAC
882	GANDALF	I.806 D	346	SVEND HENNINGSEN	5.95		L12:45	L18:40		S08:21:19	42:51:19	44:34:39	PR 1
884	MUSEN	I.806 D	380	JØRGEN THORSTED	5.95	L02:40	L13:00	L19:00		S08:32:24	43:02:24	44:45:44	PR 2
879	BLÅKANT	I.806 D	307	SØREN & PER KAARE	5.95			L18:55		S08:48:20	43:18:20	45:01:40	3
885	NN	I.806 D	389	EGGERT G. JØRGENSEN	5.95	L02:50		L19:00	S02:23	S08:54:28	43:24:28	45:07:48	4
878	VANDMELONEN	I.806 D	121	PETER HEGNHØJ	5.95	L03:10		L19:00	S02:40	S08:58:29	43:28:29	45:11:49	5
886	CHIANG MAI	I.806 D	390	HENRIK NØRGAARD	5.95	L03:15	L12:35	L19:40		S09:40:44	44:10:44	45:54:04	6
881	STRESS	I.806 D	343	T. GOTTLIEB	5.95	L03:25	L14:20	L20:10		S10:08:47	44:38:47	46:22:07	7
883	GENTILLE	I.806 D	347	TOM VENDELBO	5.95	L02:50		L19:05		S08:26:40	42:56:40	46:40:00+2	8
880	DENVI	I.806 D	336	PETER NIELSEN	5.95	L03:10		L20:05		S11:03:33	45:33:33	49:16:53+2	9

LØB 57 FENIX (STANDARD)

NR.	BÅDNAVN	TYPE	SEJLNR	BÅDENS FØRER	MÅL	ODDEN	AGERSØ	KALVEH	SALTH.	HELSEINGØR	SEJLTID	POINTTID	PLAC
889	BLUE HEAVEN	FENIX	339	MOGENS TAPPER	5.75	L02:40		L18:55	S02:23	S08:53:29	43:23:29	44:30:53	PR 1
892	ROSA	FENIX D	625	JENS KJÆRSGÅRD	5.75	L02:30		L19:00		S09:04:45	43:34:45	44:42:09	PR 2
895	ILLUSION	FENIX	703	JAN SCHACHTSCHABEL	5.75	L03:20	L14:11	L20:05		S10:00:35	44:30:35	45:37:59	PR 3
897	KALABALIK	FENIX	863	GEORG HØJMAN	5.75	L03:30	L14:21	L20:20		S10:43:50	45:13:50	46:21:14	4
894	FIFONG	FENIX D	693	KNUD O. ENGELSHOLM	5.75	L04:14	L15:01	L20:40		S10:59:53	45:29:53	46:37:17	5
899	MØJS	FENIX D	918	FINN HOLM-PETERSEN	5.75					S11:33:34	46:03:34	47:10:58	6
887	NO I	FENIX	1	MATS ERIKSSON	5.75	L04:26	L15:10	L20:55		S11:54:38	46:24:38	47:32:02	7
893	UNO	FENIX D	642	PHILIP H. F. NIEL	5.75			L20:55		S11:59:05	46:29:05	47:36:29	8
891	HULDRA	FENIX D	431	MADS ERICHSEN/F. JESSEN	5.75	L04:32	L15:38	L21:05		S12:38:56	47:08:56	48:16:20	9
888	FEIGA	FENIX D	250	FLEMMING HØJER	5.75	L04:21		L21:15		S13:51:44	48:21:44	49:29:08	10
896	LINDE	FENIX D	744	ERIK KASTEBO	5.75	L04:53		L21:45		S14:26:26	48:56:26	50:03:50	11
900	ACONTO	FENIX D	1001	LONE HANSEN	5.75		L17:00		S07:25	S14:29:43	48:59:43	50:07:07	12
890	AOFINE	FENIX D	416	CARL-OVE THOR	5.75	L05:07	L16:15	L20:55		S14:38:31	49:08:31	50:15:55	13
898	KRIS-FENIX	FENIX D	908	OLE LARSEN	5.75					IKKE STARTET			

LØB 58 POLARIS DRABANT (STANDARD)

NR.	BÅDNAVN	TYPE	SEJLNR	BÅDENS FØRER	MÅL	ODDEN	AGERSØ	KALVEH	SALTH.	HELSEINGØR	SEJLTID	POINTTID	PLAC
915	MIMI	POL.DR D	222	JESPER KLENUM	5.45	L02:35	L13:05	L19:11	S02:32	S09:01:11	43:31:11	43:41:10	PR 1
902	MARU	POL.DR D	14	AXEL DREWS	5.45		L13:25	L19:20	S02:45	S09:06:15	43:36:15	43:46:14	PR 2
909	SLUPPEN	POL.DR D	131	OTTO BAY	5.45	L02:57	L13:33	L19:35		S10:06:13	44:36:13	44:46:12	PR 3
913	LADY KLUK	POL.DR D	211	ANDERS BANGERT	5.45	L03:10	L13:50	L19:50		S10:07:49	44:37:49	44:47:48	PR 4
907	PLUS	POL.DR D	109	OLE ADAMSEN	5.45	L03:35		L20:15		S10:17:24	44:47:24	44:57:23	5
905	BETH	POL.DR D	63	HELGE KINGO	5.45	L02:55	L13:41	L19:45		S10:28:13	44:58:13	45:08:12	6
908	LUNA	POL.DR D	126	JOHANNES KILDEBY	5.45	L03:40	L14:25	L20:20		S10:40:12	45:10:12	45:20:11	7
910	DRABANTEN	POL.DR D	132	OLE HJORTH	5.45		L14:32			S10:42:02	45:12:02	45:22:01	8
916	NOKKE	POL.DR D	226	LARS FALBE-HANSEN	5.45	L03:55	L14:55	L20:40		S11:08:40	45:38:40	45:48:39	9
903	LA PJEVS	POL.DR D	25	JENS KVISGAARD	5.45	L03:45		L20:55		S12:10:19	46:40:19	46:50:18	10
904	AGNETE	POL.DR D	33	CHR. HANSEN	5.45		L17:40	L23:25	S14:55	S22:41:56	57:11:56	57:21:55	11
906	SOFIE	POL.DR D	66	JENS KONDRUP	5.45	L05:52	L17:35	L23:25	S14:45	S23:15:58	57:45:58	57:55:57	12
918	GULNARE	POL.DR D	276	FRANK RICHTER	5.45	L07:16		S04:15		M01:52:07	60:22:07	60:32:06	13
912	VICTORIA	POL.DR D	188	SUSANNE HONORE	5.45	L06:09	L20:55	S04:20	S19:20	M01:45:51	60:15:51	62:25:50+2	14
911	WAWA	POL.DR D	136	JOHN LUNAU DAM	5.45	L07:48		S04:30		M03:30:16	62:00:16	64:10:15+2	15
914	MERI	POL.DR D	216	ERIK LARSEN	5.45					UDGÅET			
917	DAVY JONES	POL.DR D	230	BIRGIT JENSEN	5.45					IKKE STARTET			

RESULTATLISTE SJÆLLAND RUNDT 1988

7. START FREDAG 13:30 BANE 2 - GENNEM BØGESTRØMMEN

215 SØMIL

LØB 59 DRABANT 24 (STANDARD)

NR.	BÅDNAVN	TYPE	SEJLNR	BÅDENS FØRER	MÅL	ODDEN	AGERSØ	KALVEH	SALTH.	HELINGØR	SEJLTID	POINTTID	PLAC	
937	JEANLI	DRA.24	D	163	STEEN RAUN	5.60	L03:10	L14:02	L19:55		S10:11:44	44:41:44	45:21:00	PR 1
932	ATHOS	DRA.24	D	145	PREBEN ØSTFELDT	5.60	L03:20	L14:17	L20:10		S10:30:22	45:00:22	45:39:38	PR 2
925	GODTNOK	DRA.24	D	71	FOLKE GALSGAARD	5.60	L03:25	L14:20	L20:10		S10:30:33	45:00:33	45:39:49	PR 3
930	BO-DILLE	DRA.24	D	132	HELMUTH SCHWARZ	5.60	L03:20	L14:17	L20:10		S10:36:09	45:06:09	45:45:25	PR 4
924	WIVA II	DRA.24	S	58	HANS NILSSON	5.60	L03:35				S11:13:14	45:43:14	46:22:30	5
921	PEANUTS	DRA.24	D	14	GUNNER NYHOLM	5.60	L03:40		L20:30		S11:24:05	45:54:05	46:33:21	6
926	PRESIDENT	DRA.24	D	81	JACOB ANDREASEN	5.60	L04:17	L15:21	L21:00		S11:59:09	46:29:09	47:08:25	7
931	FIRKLØVER	DRA.24	D	138	TONNY HASSEL HANSEN	5.60	L04:12	L15:30			S12:53:12	47:23:12	48:02:28	8
936	ESCAPE	DRA.24	D	161	LEIF PEDERSEN	5.60	L04:10		L21:20		S12:53:21	47:23:21	48:02:37	9
923	GRETE	DRA.24	D	45	HANS BAARREGAARD	5.60	L04:21	L15:24	L17:00		S12:56:35	47:26:35	48:05:51	10
934	ARAMIS	DRA.24	D	147	MICHAEL HJORT-PEDERSEN	5.60	L04:36	L15:50	L21:25		S13:03:23	47:33:23	48:12:39	11
927	TJALDUR	DRA.24	D	94	FRANK WEYHE	5.60		L15:34	L21:25	S08:49	S13:50:15	48:20:15	48:59:31	12
928	MUGGE	DRA.24	D	101	MOGENS GRUBBE	5.60	L04:40	L16:05	L21:55		S14:12:05	48:42:05	49:21:21	13
933	PORTHOS	DRA.24	D	146	LISBETH HAGGE	5.60	L04:40	L16:15	L22:00	S06:30	S14:21:33	48:51:33	49:30:49	14
920	POURQUOT PAS	DRA.24	D	11	THØGER SECHER	5.60	L06:06		S04:50	S18:15	M00:42:39	59:12:39	59:51:55	15
935	ARIEL II	DRA.24	D	156	OTTO GØTTSCHE	5.60	L06:06	L20:58	S04:30	S19:55	M01:57:47	60:27:47	61:07:03	16
922	JUPITER	DRA.24	D	28	CARL-ERIK WEBER KOCK	5.60	L06:02	L20:54	S05:05		M02:56:30	61:26:30	62:05:46	17
929	RISSE	DRA.24	D	124	STEEN PETERSEN	5.60	L07:04		S04:20	S20:15	M03:44:39	62:14:39	62:53:55	18

LØB 60 L.23 (STANDARD)

NR.	BÅDNAVN	TYPE	SEJLNR	BÅDENS FØRER	MÅL	ODDEN	AGERSØ	KALVEH	SALTH.	HELINGØR	SEJLTID	POINTTID	PLAC	
943	THALATTA	L.23	D	79	KIM PAASKE	5.45	L03:15	L14:21	L20:20		S10:52:37	45:22:37	45:32:36	PR 1
939	KILLE LOCK	L.23		18	ROBERT CHRISTENSEN	5.45	L03:30		L20:30		S11:18:36	45:48:36	45:58:35	PR 2
948	RAM	L.23	D	158	LARS PAGH PETERSEN	5.45	L03:35	L15:06	L21:00		S12:39:35	47:09:35	47:19:34	PR 3
938	BELICIA	L.23	D	12	ELO UNGER	5.45	L03:40	L15:08	L21:00		S12:39:54	47:09:54	47:19:53	PR 4
951	HEBRIKA	L.23	D	324	ERIK NIELSEN	5.45	L04:21		L21:20		S12:56:57	47:26:57	47:36:56	5
946	TO BE	L.23	D	98	TORKILD STÆRK	5.45		L15:35	L21:20		S13:01:59	47:31:59	47:41:58	6
940	MOBEKA	L.23	D	21	K GALLWITSS CARLSEN	5.45	L03:50	L15:30	L21:20		S13:11:34	47:41:34	47:51:33	7
950	JANE 2	L.23	D	250	JAN NIELSEN	5.45		L15:32	L21:15		S13:21:05	47:51:05	48:01:04	8
941	GULNARE	L.23	D	26	POUL TEJLGAARD	5.45	L04:40	L16:25	L21:55	S06:35	S14:49:33	49:19:33	49:29:32	9
953	SEA WORLD	L.23	D	331	JØRGEN LUND	5.45	L04:49	L16:25	L22:07	S07:30	S14:59:09	49:29:09	49:39:08	10
947	PRISELLA	L.23	D	150	MICKY W. FOGT	5.45	L04:32	L16:20	L21:55	S06:30	S14:13:29	48:43:29	50:53:28+2	11
954	FIFI	L.23	D	401	ERIK OVGAARD	5.45	L08:01		S04:05	S18:05	M00:02:53	58:32:53	58:42:52	12
942	SPAR ES	L.23	D	56	PETER BERG	5.45	L06:53	L21:15	S05:20	S19:45	M03:32:28	62:02:28	62:12:27	13
952	JAZZ	L.23	D	330	MORTEN LORENZEN	5.45	L03:45		L20:35		DISKVALIFICERET			
944	DEBBIE	L.23	D	81	DARIO BENDSEN	5.45					IKKE STARTET			
945	LA BELL	L.23	D	91	CLAUS SILLEHOVED	5.45					IKKE STARTET			
949	AMOK	L.23	D	176	PER NIELSEN	5.45					IKKE STARTET			

LØB 61 BANNER 28 RACER

NR.	BÅDNAVN	TYPE	SEJLNR	BÅDENS FØRER	MÅL	ODDEN	AGERSØ	KALVEH	SALTH.	HELINGØR	SEJLTID	POINTTID	PLAC	
965	DEN SORTE ENGEL	BAN28R	D	185	MARTIN RICH	6.60	L01:45	L10:52	L16:33	L23:50	S04:13:58	38:43:58	42:13:01	PR 1
958	BRASSO	BAN28R	D	110	TORBEN B OLSEN	6.60	L01:50	L11:05	L16:45	L23:55	S04:21:31	38:51:31	42:20:34	PR 2
960	BLÅFRYD	BAN28R	D	138	JØRGEN BILLESBØLLE	6.60	L01:50	L11:05	L16:45	L23:55	S04:22:47	38:52:47	42:21:50	PR 3
962	X-KILLER	BAN28R	D	159	JØRN JENSEN	6.60	L01:55	L11:28	L17:15	S00:23	S05:27:40	39:57:40	43:26:43	4
959	SPANKING LADY	BAN28R	D	132	KIM FOGDE	6.60	L02:15	L12:00	L17:40	S00:48	S06:06:22	40:36:22	44:05:25	5
956	SUG-ELLEN	BAN28R	D	14	CLAUS LINDE SØRENSEN	6.60	L03:45	L14:25	L20:05		S09:38:43	44:08:43	47:37:46	6
961	TURBOLÆNS	BAN28R	D	155	BENNY OLESEN	6.60					UDGÅET			
957	WINDFLOWER	BAN28R	D	15	JENS LARSEN	6.55	L02:57	L12:45	L18:45		DISKVALIFICERET			
955	RED ARROW	BAN28R	D	7	JØRGEN BO LARSEN	7.15					IKKE STARTET			
963	GRÅSKÅG	BAN28R	D	160	MIKAEL JENSEN	6.55					IKKE STARTET			
964	O'YES	BAN28R	D	174	JES JOHNSEN	6.60					IKKE STARTET			

RESULTATLISTE SJÆLLAND RUNDT 1988

7. START FREDAG 13:30 BANE 2 - GENNEM BØGESTRØMMEN

215 SØMIL

LØB 62 DH 5.65 - 7,85

NR.	BÅDNAVN	TYPE	SEJLNR	BÅDENS FØRER	MÅL	ODDEN	AGERSØ	KALVEH	SALTH.	HELSINGØR	SEJLTID	POINTTID	PLAC
973	SECOND WIFE	LARS.25 D	30	BO SELKO	6.15		L11:18		S00:17	S05:00:46	39:30:46	41:48:22	PR 1
1447	SPIRITUS GRAVIS	RJ.85 D	148	ANDERS VERNER JENSEN	5.70	L02:30	L12:25	L18:25		S08:06:50	42:36:50	43:34:59	PR 2
971		LARS.25 D	3	ARNE LARSEN	6.20	L01:55	L11:50	L17:40		S07:19:05	41:49:05	44:14:59	PR 3
972	NAJA	LARS.25 D	9	HENRIK ADLER-NIELSEN	6.25	L02:50	L13:00	L18:55	S02:08	S08:25:46	42:55:46	45:29:53	PR 4
970	APOLONARIS	J.24 D	980	C. E. LUNDSSGAARD	5.80	L03:10	L14:06	L20:00		S10:05:07	44:35:07	45:51:41	5
1448	SIF	RJ.85 D	332	BRØDRENE DYLOV	5.70	L03:00		L19:20		S09:17:18	43:47:18	46:45:27+2	6
974	SPAREGRISEN	MARSVIN D	2	JENS NØRMARK OLSEN	5.80	L03:55	L15:22	L21:05		S12:10:46	46:40:46	47:57:20	7
1445	CHINOOK	RJ.85 D	101	FRITS JANUM	5.50	L04:58		L22:05		S14:22:05	48:52:05	49:11:58	8
979	STÆRK SOVS	TABAS26 D	42	BJARNE ZINKERNAGEL	6.25	L05:02	L16:00	L21:40		S13:52:59	48:22:59	50:57:06	9
978	BANDIT	SUN-D28		JOHN JENSEN	6.40	L05:14	L16:30	L22:40	S08:18	S16:19:51	50:49:51	53:48:02	10
1446	KALORIUS	RJ.85 D	138	JØRGEN PREUSS	5.40	L05:39	L17:15	L23:05	S17:10	S23:30:33	58:00:33	58:00:33	11
967	TO	FEE.286 D	15	RENÉ PETERSEN	6.40	L08:30			S23:55	M07:27:16	65:57:16	68:55:27	12
966	KONG KURS	EYGT24 D	124	SØREN HOLM	5.65	L06:02	L11:05	S05:25		DISKVALIFICERET			
968	CHIV	FEE.286 D	183	IVAN JENSEN	6.25					IKKE STARTET			
969	VEAL VINYL	J.24 S	58	CHRISTER EKSTRAND	5.90					IKKE STARTET			
975	MYGSTIK	MOSQUI D	3	NIELS JØRGENSEN	6.80					IKKE STARTET			

LØB 63 ALBIN EXPRESS (STANDARD)

NR.	BÅDNAVN	TYPE	SEJLNR	BÅDENS FØRER	MÅL	ODDEN	AGERSØ	KALVEH	SALTH.	HELSINGØR	SEJLTID	POINTTID	PLAC
983	KALDMIGBAREKURT	ALB.EXP D	609	PETER LAURSEN	6.20	L02:30	L12:42	L18:35		S08:27:13	42:57:13	45:23:07	PR 1
982	EXITER	ALB.EXP	145	ANDERS MØLLERSTRØM	6.20			L19:05		S08:31:38	43:01:38	45:27:32	PR 2
980	WILMA	ALB.EXP D	84	LÜTZHÖFT/ BOHMANN	6.20					S08:35:30	43:05:30	45:31:24	3
981	BEAGLE	ALB.EXP D	90	BODO RUPSCH	6.20	L03:00		L19:11		S08:48:54	43:18:54	45:44:48	4
984	JOSIE	ALB.EXP D	634	HENRIK MØLLER	6.20	L02:45	L13:20	L20:55		S08:52:27	43:22:27	45:48:21	5
987	KLØVEREN	ALB.EXP D	760	FLEMMING BORCH	6.20	L03:30	L14:10	L19:55		S09:53:01	44:23:01	46:48:55	6
989	MALIBU	ALB.EXP S	944	CHARLOTTA WESTBERG	6.20	L03:30	L14:25	L20:15		S10:31:29	45:01:29	47:27:23	7
985	TIKKA	ALB.EXP D	679	SØREN EIBYE	6.20	L04:00	L14:40	L20:15		S10:48:24	45:18:24	47:44:18	8
988	MULLE	ALB.EXP D	840	FRANK AAGAARD	6.20	L04:14		L20:45		S11:17:32	45:47:32	48:13:26	9
986	SIF	ALB.EXP D	735	SØREN W. RASMUSSEN	6.20	L04:17	L15:18	L21:05		S12:40:38	47:10:38	49:36:32	10

LØB 64 BIANCA 28

NR.	BÅDNAVN	TYPE	SEJLNR	BÅDENS FØRER	MÅL	ODDEN	AGERSØ	KALVEH	SALTH.	HELSINGØR	SEJLTID	POINTTID	PLAC
1778	MARTINIQUE	BIA.28 S	80	MARTIN HELLEKANT	5.80	L03:15				S10:35:53	45:05:53	46:22:27	PR 1
994	MAPS	BIA.28 D	211	PETER SCHWARZBERG	5.80	L04:15	L15:21	L21:05		S12:23:03	46:53:03	48:09:37	PR 2
998	TARO	BIA.28 D	252	LEIF DANNEMANN JENSEN	5.80		L15:05	L21:05		S12:30:46	47:00:46	48:17:20	PR 3
1000	TWIGGY	BIA.28 D	406	BJARNE MØLLER-KRISTENSEN	5.60	L04:19	L15:34			S13:14:15	47:44:15	48:23:31	4
995	YO-YO	BIA.28 D	219	PETER WENNECKE	5.80	L04:32	L15:42	L21:30		S13:40:37	48:10:37	49:27:11	5
992	LIV-LINE	BIA.28 D	144	ERIK THOMSEN	5.85	L04:14	L16:00	L21:40	S06:42	S14:45:13	49:15:13	50:40:49	6
996	LAND HO	BIA.28 D	233	PETER BERNT	5.80	L04:36		L22:07	S08:52	S16:42:10	51:12:10	52:28:44	7
991	LARINAE	BIA.28 D	76	JOHN ØDEGÅRD	5.85	L06:37	L21:08	S04:10	S19:45	M02:45:16	61:15:16	62:40:52	8
993	DEN GULE ENKE	BIA.28 D	167	MOGENS FOGH	5.80	L09:45				UDGÅET			
997	BETH	BIA.28 D	250	ALLAN TANGHØJ	5.70			L23:40		UDGÅET			
999	BULLER	BIA.28 D	299	POUL ERIK RASMUSSEN	5.80			S04:50		UDGÅET			
990	A'LIVE	BIA.28 D	7	V. HAGELBERG	5.90	L03:55	L17:00	L22:07		DISKVALIFICERET			

”Gaver der glæder..”



**HOLME
GAARD**
OF COPENHAGEN

BY APPOINTMENT TO
THE ROYAL DANISH COURT
KONGELIG HOFLEVERANDØR

RESULTATLISTE SJÆLLAND RUNDT 1988

8. START FREDAG 14:00 BANE 1 - GENNEM GRØNSUND

236 SØMIL

LØB 66 B.31

NR.	BÅDNAVN	TYPE	SEJLNR	BÅDENS FØRER	MÅL	ODDEN	AGERSØ	SKANSE	SALTH.	HELSINGØR	SEJLTID	POINTTID	PLAC
1001	DULLER	B.31	D 292	TOMMY SCHULER	6.20	L03:20		L19:52		S13:31:22	47:31:22	51:57:32	PR 1
1008	FLEKI	B.31	D 1097	F B MADSEN	6.25	L03:55	L14:47	L20:15	S07:00	S13:59:14	47:59:14	52:34:24	PR 2
1003	SUS-I	B.31	D 573	POUL ERIK LARSEN	6.20	L01:55	L14:52	L20:20	S07:00	S14:27:37	48:27:37	52:53:47	3
1010	DONNA	B.31	D 1147	ORLA K. JENSEN	5.90	L05:11	L16:00	L21:26	S08:42	S15:50:49	49:50:49	53:20:34	4
1005	MIKKI	B.31	D 1012	SØREN C. WILLMAN	6.25	L05:14	L16:15	L21:34	S08:55	S16:15:23	50:15:23	54:50:33	5
1006	MY LADY	B.31	D 1018	STEEN WILLUMSEN	6.20	L05:11	L16:25	L21:56		S17:24:02	51:24:02	55:50:12	6
1002	LENETT	B.31	D 572	ERIK NIELSEN	6.20			S04:35	S22:05	M03:45:17	61:45:17	66:11:27	7
1004	AGANE	B.31	D 578	MICHAEL BOHNSACK	6.15	L07:09	L20:58	S03:55	S20:05	M02:11:20	60:11:20	66:28:22+2	8
1007	SIRENA	B.31	D 1046	BENT NIELSEN	6.20	L06:56		S05:15	S23:35	M05:39:56	63:39:56	68:06:06	9
1009	TEAKI	B.31	D 1112	POUL MARTINUSSEN	6.20					UDGÆT			

LØB 67 BALLAD (STANDARD)

NR.	BÅDNAVN	TYPE	SEJLNR	BÅDENS FØRER	MÅL	ODDEN	AGERSØ	SKANSE	SALTH.	HELSINGØR	SEJLTID	POINTTID	PLAC
1038	PINGVINO II	BALLAD	D 934	H. P. JOHANSEN	6.15		L13:46	L19:20		S12:36:13	46:36:13	50:53:15	PR 1
1048	GYNEKA VI	BALLAD	1222	BJÖRN WIDELL	6.15	L03:15	L13:50	L19:31		S12:40:48	46:40:48	50:57:50	PR 2
1013	LAZY LADY	BALLAD	S 179	LARS LARSSON	6.15		L13:50	L19:26		S12:41:08	46:41:08	50:58:10	PR 3
1051	AMANDA	BALLAD	D 1294	JØRGEN WINSTON RASMUSSEN	6.15	L03:30	L14:07			S13:30:44	47:30:44	51:47:46	PR 4
1025	MADAM BLÅ	BALLAD	D 453	KLAUS HANSEN	6.15	L03:40	L14:11	L19:46		S13:33:50	47:33:50	51:50:52	PR 5
1045	EMMA	BALLAD	1177	MARTIN HANSON	6.15	L03:40		L19:51	S06:17	S13:41:45	47:41:45	51:58:47	PR 6
1030	BALOO	BALLAD	529	CURT FORSGREN	6.15	L03:55	L14:42	L20:10	S06:45	S13:47:26	47:47:26	52:04:28	PR 7
1029	METTE	BALLAD	D 526	PER ÅRSETH-HANSEN	6.15	L03:45	L14:25	L19:57	S06:30	S13:47:36	47:47:36	52:04:38	PR 8
1055	INGOLF	BALLAD	D 1452	FRANK TOVBORG	6.15	L04:02	L14:47	L20:18	S06:45	S13:52:01	47:52:01	52:09:03	PR 9
1012	ASTAREA	BALLAD	G 57	GÜNTHER HEINSEN	6.15	L04:05	L14:49	L20:18	S06:45	S13:53:39	47:53:39	52:10:41	PR 10
1053	KEEP SMILING	BALLAD	1387	LEIF ENEBERG	6.15	L03:40	L14:12	L19:48		S13:56:09	47:56:09	52:13:11	11
1011	KITTER	BALLAD		ANDERS HOFFMEYER	6.15	L03:35	L14:27	L20:03	S06:55	S13:57:11	47:57:11	52:14:13	12
1057	SIRI	BALLAD	D 2001	JENS DAUGAARD-JENSEN	6.15	L04:12		L20:16	S06:55	S14:00:18	48:00:18	52:17:20	13
1033	ELLIS	BALLAD	D 676	STEEN GØRRANSSON	6.15	L03:25		L19:44	S21:10	S14:01:01	48:01:01	52:18:03	14
1039	HAJA GRÄDDNOS	BALLAD	950	PETER OXHARE	6.15	L03:20	L14:06	L19:39		S14:03:15	48:03:15	52:20:17	15
1024	N.N.	BALLAD	D 411	ERIK BAY	6.15	L04:00		L20:10	S06:45	S14:06:04	48:06:04	52:23:06	16
1058	BALLADDIN	BALLAD	D 2006	J.BIRKEGÅRD+ERIK AGERHOLM	6.15	L03:40	L14:23	L20:03	S07:00	S14:09:06	48:09:06	52:26:08	17
1042	ANNE II	BALLAD	D 998	HANS BRØCHNER-MORTENSEN	6.15	L03:45		L20:13		S14:09:35	48:09:35	52:26:37	18
1032	MAJESTIC	BALLAD	D 629	IB ANDERSEN	6.15	L03:55	L14:55	L20:22	S07:10	S14:14:33	48:14:33	52:31:35	19
1047	MADAME	BALLAD	1215	RICHARD NILSSON	6.15	L04:00		L20:10	S06:45	S14:15:43	48:15:43	52:32:45	20
1019	SALOME	BALLAD	D 335	CARSTEN HVIID-NIELSEN	6.15	L04:12	L14:49	L20:16	S06:55	S14:20:37	48:20:37	52:37:39	21
1049	EMILIE	BALLAD	D 1244	KAJ KVISTGAARD	6.15	L04:17	L15:01	L20:33	S07:27	S14:21:07	48:21:07	52:38:09	22
1050	SHANTY	BALLAD	D 1249	BENT JEPPESEN	6.15	L04:26	L15:08	L20:44	S07:30	S14:22:32	48:22:32	52:39:34	23
1021	ANNE-LENE	BALLAD	D 363	J.R. DISSING	6.15	L04:07	L15:00		S07:25	S14:23:38	48:23:38	52:40:40	24
1040	STUMPUS	BALLAD	D 971	RONALD SØRENSEN	6.15	L04:15	L15:07	L20:36	S07:30	S14:25:11	48:25:11	52:42:13	25
1016	FLAIR	BALLAD	D 287	FOSS/JENSEN	6.15		L14:47	L20:18	S07:00	S14:29:11	48:29:11	52:46:13	26
1028	SØSPURVEN	BALLAD	D 513	PREBEN GELT	6.15	L03:35		L20:00	S06:30	S14:33:15	48:33:15	52:50:17	27
1043	HEVIAN	BALLAD	D 1015	OLE BYRGESEN	6.15	L04:36	L15:18	L20:49	S07:35	S14:34:32	48:34:32	52:51:34	28
1020	PAMI	BALLAD	D 353	JØRGEN ÅRENLUND	6.15	L04:19	L15:05	L20:33	S07:25	S14:40:09	48:40:09	52:57:11	29
1031	JONICA	BALLAD	D 549	OLAF JØRGENSEN	6.15	L04:02	L15:07	L20:40	S08:00	S15:02:46	49:02:46	53:19:48	30
1023	SHALOM	BALLAD	D 376	ANKER LARSEN	6.15	L05:39	L16:15	L21:32	S08:11	S15:12:26	49:12:26	53:29:28	31
1036	LUTTICA	BALLAD	909	GÖSTA TORNBORG	6.15	L04:36	L14:42	L20:55		S15:21:16	49:21:16	53:38:18	32
1034	PASCAL	BALLAD	D 683	TORBEN PLESS	6.15	L04:36	L15:42	L21:12	S08:10	S15:30:38	49:30:38	53:47:40	33
1052	DIONE	BALLAD	D 1316	HOLGER NIELSEN	6.15	L04:05	L14:49	L20:18	S06:55	S14:10:31	48:10:31	54:27:33+2	34
1015	BOSANOVA	BALLAD	D 231	STEFFEN GRIMM	6.15	L06:26	L20:55	S03:57	S19:45	M01:45:46	59:45:46	64:02:48	35
1035	LAMONA	BALLAD	751	FREDRIK PEYRON	6.15	L07:07			S23:35	M05:46:16	63:46:16	68:03:18	36
1014	MISJA	BALLAD	D 230	BENT FRANSEN	6.15	L06:46	L21:06	S04:40	M00:10	M06:06:27	64:06:27	68:23:29	37
1017	RELAX II	BALLAD	D 296	J.H. FREDERIKSEN	6.15	L08:20		S04:40	S23:50	M06:09:24	64:09:24	68:26:26	38
1041	MILLIE II	BALLAD	D 974	JOHN JENSEN	6.15	L10:25				UDGÆT			
1027	ELISABETH	BALLAD	D 475	S ENEVOLDSEN	6.15			L20:33		DISKVALIFICERET			
1044	PLAKA	BALLAD	D 1115	KNUD DAHLGAARD	6.15	L09:05		S05:41		DISKVALIFICERET			
1054	TINA	BALLAD	D 1445	JESPER ERICHSEN	6.15	L04:17	L15:00	L20:39	S07:27	DISKVALIFICERET			
1018	CONFETTI	BALLAD	D 315	JOHN MENÅ	6.15	L03:15	L15:39	L21:20	S08:23	DISKVALIFICERET			
1022	SIMBANG	BALLAD	D 375	JOHAN PHILIP TRAMPE	6.15	L06:15		L23:05	S15:10	DISKVALIFICERET			
1026	WINDY	BALLAD	D 455	JAN L. NIELSEN	6.15					IKKE STARTET			
1037	ATHENE	BALLAD	D 929	JENS MADSEN	6.15					IKKE STARTET			
1046	BALOO III	BALLAD	D 1203	JENS HOLBAK	6.15					IKKE STARTET			
1056	TRINE	BALLAD	D 1492	SVEN LARSEN	6.15					IKKE STARTET			
1059	IMPULSIV	BALLAD	D 2016	NIELSEN/VITTRUP	6.15					IKKE STARTET			

RESULTATLISTE SJÆLLAND RUNDT 1988

8. START FREDAG 14:00 BANE 1 - GENNEM GRØNSUND

236 SØMTL

LØB 72 DH 4.95 - 10.00

NR.	BÅDNAVN	TYPE	SEJLNR	BÅDENS FØRER	MÅL	ODDEN	AGERSØ	SKANSE	SALTH.	HELSEINGØR	SEJLTID	POINTTID	PLAC
1373	BLUE ANGEL	IMP.30	D 17	NELS C. S. NIELSEN	6.40	L02:50	L12:35	L18:05		S09:53:39	43:53:39	48:55:15	PR 1
1118	ATLANTIC	ATALIA	D 6	BENGT LARSEN	6.55	L02:40	L12:35	L17:11		S10:23:05	44:23:05	49:50:15	PR 2
1121	PINTA	BIA.RI	D 1	PEDER PETERSEN	6.45	L02:45	L12:55	L17:42		S11:02:43	45:02:43	50:12:56	PR 3
1130	MARIONET	DRA.30	D 15	JENS ANDREASEN	6.25	L03:00	L13:20	L18:56		S12:18:12	46:18:12	50:53:22	PR 4
919	GUSTAVA	POL.DR	D 288	JØRGEN LIND	5.70	L03:35	L14:25	L20:08		S14:05:35	48:05:35	50:55:24	PR 5
1146	SUSETTE	GRAN910	D 44	M. LUND	6.25	L02:57		L18:55		S12:22:48	46:22:48	50:57:58	PR 6
1132	BLUEBELL	DRA.30	D 58	JØRGEN ANDERSEN	6.00	L03:40		L19:56	S06:30	S13:56:13	47:56:13	51:45:12	PR 7
1120	PUSSER II	BIA.LI	D 6	OLE RITTERMAN	6.65	L02:55		L17:42		S12:08:06	46:08:06	51:51:50	PR 8
1125	TEMPO/GIGANTE	DEHL.31	D 621	BJARN LIND	6.50	L03:30	L13:58			S13:01:57	47:01:57	52:20:40	PR 9
1142	AQUARIUS	GRAN910	D 29	BENT ANDERSEN	6.30	L03:55	L14:47	L20:10	S06:35	S13:42:05	47:42:05	52:26:08	10
1144	RITH	GRAN910	D 39	JAN SCHOU PETERSEN	6.30	L03:45	L14:32	L12:09	S06:30	S13:57:07	47:57:07	52:41:10	11
1149	T'AI CHI	TRIO	D 48	JOHN DILLING	6.50	L03:35	L14:04	L19:52		S12:27:43	47:27:43	52:46:26	12
1140	PROLIFIC III	GAMBLIN	S 2	MAGNUS MATELL	6.75	L03:15	L13:28	L19:04		S12:51:31	46:51:31	52:51:27	13
1143	DORTHEA	GRAN910	D 31	BENT LAULUND	6.30	L03:45		L20:03	S06:45	S14:32:23	48:32:23	53:16:26	14
1116	AIDA	ALB.DEL	D 108	IB DANIELSEN	6.35	L03:55	L14:40	L20:18	S07:00	S14:30:12	48:30:12	53:23:04	15
1122	CHALOMARE	BIA.RI	D 6	W. KIERSTEIN	6.45	L04:21	L14:55	L20:18	S06:55	S14:13:52	48:13:52	53:24:05	16
1151	EAGLE	WASA270	D 1127	HANS LARSEN	6.15	L04:49	L15:36	L20:59	S07:55	S15:11:21	49:11:21	53:28:23	17
1128	WOODSTOCK	DRA.30	D 3	STEEN HASSELRIIS	6.25	L04:40	L15:36	L21:00	S08:00	S15:01:24	49:01:24	53:36:34	18
1483	ELISABETH	DEHL.98	D 901	PETER TVERSTED	6.35	L05:02	L15:34	L21:01	S07:35	S14:52:04	48:52:04	53:44:56	19
1129	BELL	DRA.30	D 7	JERPE H FISKE	6.05	L04:32		L20:59	S08:34	S15:54:47	49:54:47	53:53:15	20
1141	MAJADAN	GRAN910	D 11	TEDDY B. RASMUSSEN	6.35	L04:21		L20:54	S08:18	S15:34:29	49:34:29	54:27:21	21
1148	AMANDA	SUNRISE	S 5175	LARS WERNERSSON	6.30	L05:02	L15:55	L21:26	S08:24	S15:58:39	49:58:39	54:42:42	22
1117	ARIES	ALB.DEL	D 135	LARS TUXEN	6.35	L04:49	L15:55	L21:38		S16:09:07	50:09:07	55:01:59	23
1131	DUE'ET	DRA.30	D 17	DAN SUDSGAARD	6.10	L06:20		L22:14		S16:55:41	50:55:41	55:03:29	24
1126	LOTUS	DEHL.31	D 693	JØRGEN GAD	6.20	L06:24	L17:09	L22:30	S10:00	S17:41:00	51:41:00	56:07:10	25
1133	KIKI	ELAN.31	D 75	PALLE K LUND	7.10	L05:43	L16:05	L21:11		S15:28:57	49:28:57	56:23:03	26
1127	JEGILA	DEHL.31	D 801	MØGENS LARSEN	6.55	L05:52	L17:00	L22:30	S10:00	S18:10:06	52:10:06	57:37:16	27
1136	TAPPENSTREGEN	ETAP	30	PALLE DAHL	6.30			L20:08	S07:15	M02:14:45	60:14:45	64:58:48	28
1135	NINUS	ESP.990	D 908	SVEN NIELSEN	6.05	L06:34	L20:55	S04:06		M03:31:49	61:31:49	65:30:17	29
1139	AMOUR	FOLIE30	D 430	LARS PETER JENSEN	5.95	L06:32	L20:57	S03:57	S20:15	M03:52:54	61:52:54	65:32:20	30
1114	CARITA	1/2 TON	D 165	H.J. JESSEN	5.60	L07:07				M05:57:04	63:57:04	66:26:10	31
901	FEDSILDEN	POL.DR	D 1	STURE LINDGREN	5.45	L08:20		S05:30	M00:20	M08:15:11	66:15:11	68:12:09	32
1134	HEPAS II	ELAN.31	D 84	HANS HOTHER POULSEN	6.95	L06:43	L21:11	S04:19	S21:55	M03:49:04	61:49:04	68:20:26	33
1137	KREBSEN	FEEL850	D 525	FLEMMING KREBS	6.35	L07:07	L20:55	S05:12	S23:50	M06:01:28	64:01:28	68:54:20	34
1123	ANN MARIE	COMF30	S 506	GÖRAN HOLMQVIST	6.45					UDGÅET			
1124	MURPHEY	CROWN31	D 1	STEEN BRESEMANN	6.80	L07:04	L15:31	L22:30		UDGÅET			
1145	JACQUELINE	GRAN910	D 42	KLAUS VINTER	6.30	L04:02	L15:05	L20:33	S07:15	DISKVALIFICERET			
1119	LILLEFIX	BAVA.30	D 147	CARL BRUHN	7.00	L06:36	L21:08	S04:12	S22:30	DISKVALIFICERET			
680	POWER	FENIX	D 122	JOHN PETERSEN	6.35					IKKE STARTET			
1115	GINE	ALB.DEL	D 96	LEIF NIELSEN	5.90					IKKE STARTET			
1138	DUCHESS	FIRS305	D 2	NIELS JESSEN	6.35					IKKE STARTET			
1147	TODDY	NEPT.32	G 5	URSULA KOPATZ	4.95					IKKE STARTET			
1150	RENAUTE	W 30	70	GÖRAN NILSSON	6.05					IKKE STARTET			

LØB 73 X-95 (STANDARD)

NR.	BÅDNAVN	TYPE	SEJLNR	BÅDENS FØRER	MÅL	ODDEN	AGERSØ	SKANSE	SALTH.	HELSEINGØR	SEJLTID	POINTTID	PLAC
1161	MISS X	X-95	G 3579	ERICH MEERBACH	6.70	L02:25		L17:35		S09:13:23	43:13:23	49:05:15	PR 1
1159	X-IL	X-95	D 154	OLE RASMUSSEN	6.70	L02:35		L17:45		S09:25:53	43:25:53	49:17:45	PR 2
1160	XANTHIPPE	X-95	D 624	ROLF JAKOBSEN	6.70	L02:45		L17:56		S09:34:59	43:34:59	49:26:51	3
1153	HAVHEXEN	X-95	D 42	THOMAS MELBYE	6.70	L02:50	L12:30	L18:00		S10:00:52	44:00:52	49:52:44	4
1155	LADY-X	X-95	D 68	PETER BRÜEL	6.70	L03:10	L13:05			S11:03:17	45:03:17	50:55:09	5
1158	MALIBU	X-95	D 134	PER NISSEN	6.70	L02:50	L13:08	L17:47		S12:12:48	46:12:48	52:04:40	6
1152	GANESHA	X-95	D 1134	SANDEEP SANDER	6.70	L03:50	L14:20	L19:46		S13:38:44	47:38:44	53:30:36	7
1154	MALIK	X-95	D 50	HALD/ BERGGREN	6.70	L03:45	L14:35	L20:08	S06:42	S13:53:33	47:53:33	53:45:25	8
1157	XPEDIT	X-95	D 113	HENRIK ANTONSEN	6.70	L03:45				UDGÅET			
1156	GIN III	X-95	D 71	CARL NORDSTRAND	6.70					IKKE STARTET			



Danmark først i mål

- når det gælder realkreditbelåning!

Personlig rådgivning er nøgleordet, når KREDITFORENINGEN DANMARK skaffer penge til huse. Uanset om det gælder nybyggeri, modernisering af badeværelse eller finansiering af erhvervslivets ejendomme.

Vi analyserer mulighederne ud fra dine behov - og »skræddersyr« en løsning, der modsvarer dine ønsker og krav. Du er altid velkommen til en uforpligtende samtale med en af vore vurderingsinspektører landet over.



Kreditforeningen
Danmark

- vi kæmper for guld til Danmark

København: Tlf. 01 12 53 00 Århus: Tlf. 06 12 53 00 Herning: Tlf. 07 12 53 00 Aalborg: Tlf. 08 12 53 00 Odense: Tlf. 09 12 53 00

RESULTATLISTE SJÆLLAND RUNDT 1988

9. START FREDAG 14:30 BANE 1 - GENNEM GRØNSUND

236 SØMIL

LØB 77 GRANADA 27

NR.	BÅDNAVN	TYPE	SEJLNR	BÅDENS FØRER	MÅL	ODDEN	AGERSØ	SKANSE	SALTH.	HELSINGØR	SEJLTID	POINTTID	PLAC	
1226	FLY	GRAN27	D	139	PETER SIDENIUS	6.15	L04:10	L14:52	L20:22	S07:10	S14:21:46	47:51:46	52:08:48	PR 1
1225	MILLE	GRAN27	D	118	PER GRØNNING	6.15	L04:17	L15:18	L20:46		S14:35:33	48:05:33	52:22:35	PR 2
1223	HOLSTKNÆGTEN	GRAN27	D	79	PREBEN STAMPE RASMUSSEN	6.10	L04:40	L15:42	L21:08	S08:20	S15:25:05	48:55:05	53:02:53	PR 3
1224	PETER PLIETSCK	GRAN27	G	90	PETER MÜLLER	6.00	L04:21	L16:15	L21:34		S15:49:24	49:19:24	53:08:23	4
1232	WILMA	GRAN27	D	284	POUL LENDAL	6.15	L04:10	L15:06	L20:36	S07:47	S15:30:27	49:00:27	53:17:29	5
1227	FILUR	GRAN27	D	151	HANS ERIK MEYER	6.15	L04:17	L15:36	L20:54		S15:32:27	49:02:27	53:19:29	6
1222	GIPSY	GRAN27	D	73	RENÉ MUNDELING	6.15				S07:47	S15:54:23	49:24:23	53:41:25	7
1230	RADISEN	GRAN27	D	275	WILMAR HOLBECH	6.10	L06:02		L22:40	S11:15	S18:17:28	51:47:28	55:55:16	8
1220	SPIRILEN	GRAN27	D	23	KNUD NYMAND	6.10	L06:06	L17:55	L21:47	S15:40	S22:28:49	55:58:49	60:06:37	9
1219	PING-PONG	GRAN27	D	10	CHEN HANGHØJ	5.95	L06:53		S04:40		M03:08:38	60:38:38	64:18:04	10
1229	NORDSTJERNEN	GRAN27	D	202	NIKLAS JOENSEN	6.20	L06:52		S04:16	S20:25	M03:14:24	60:44:24	65:10:34	11
1221	BALOO	GRAN27	D	44	KIM ELTANG	6.20	L06:43	L20:53	S05:00		M03:11:12	60:41:12	67:07:22+2	12
1231	MILLER	GRAN27	D	278	RUDY A. TYRON	6.15	L06:52	L21:15	S05:05	S23:50	M06:13:56	63:43:56	68:00:58	13
1228	AMANDA	GRAN27	D	184	PER KNUDSEN	6.10		L21:09	S06:13	M01:05	M07:44:15	65:14:15	69:22:03	14
1233	GRENADINE	GRAN27	D	285	SØREN DISSING-ANDERSEN	5.90	L06:46		S05:07		UDGÅET			

LØB 78 DH 5.05 - 6.35

NR.	BÅDNAVN	TYPE	SEJLNR	BÅDENS FØRER	MÅL	ODDEN	AGERSØ	SKANSE	SALTH.	HELSINGØR	SEJLTID	POINTTID	PLAC	
1266	GUFFE	MG C 27	D	42	HELLE HANSEN	5.75	L05:56	L16:20	L21:35		S15:16:43	48:46:43	51:46:42	PR 1
1253	MADMOISELLE	GRAN767	D	7	TOM V. JENSEN	5.80	L05:23		L21:16		S15:18:23	48:48:23	51:58:26	PR 2
1264	LIV	MAXIMAG	D	159	EGON ESPERSEN	5.80	L05:46		L21:41	S08:46	S15:37:37	49:07:37	52:17:40	PR 3
1268	XANTIPPE	NORS808	D	892	BJØRN ULLERGAARD	5.55	L06:13	L17:18	L22:30	S09:55	S16:55:35	50:25:35	52:44:06	PR 4
1260	RED MAGIC	MAXIMAG	D	40	JØRGEN KARLSSON	5.95	L06:13	L17:09	L20:20	S10:20	S17:41:05	51:11:05	54:50:31	PR 5
1239	ÆVL OG KÆVL	CTSA25	D	685	JAKOB BUUS PETERSEN	5.75					S18:35:00	52:05:00	55:04:59	PR 6
1262	SCROOGE	MAXIMAG	D	59	KURT THOMASEN	5.65	L06:09		L23:26		S22:21:36	55:51:36	58:31:08	PR 7
1250	DRØMMEPIGEN	GIB.76	D	3	NIELS JØRGEN NYMANN	5.35	L06:20	L20:55	S04:05	S19:35	M01:25:40	58:55:40	60:30:32	PR 8
1267	VALGERDUR II	NORS808	D	859	E. S. LARSEN	5.55	L07:18		S04:10	S19:25	M01:41:39	59:11:39	61:30:10	9
1251	SHOSHONE	GIB.76	D	9	JOHN TONØ	5.65	L06:50		S03:40	S19:35	M01:30:48	59:00:48	61:40:20	10
1263	JETTE SVART	MAXIMAG	D	72	MOGENS CHRISTENSEN	5.85	L06:26	L20:50	S03:20	S19:30	M01:59:49	59:29:49	62:49:47	11
1238	MIRABELLE	CTSA25	D	676	CARSTEN GOTFREDSEN	5.70	L06:41	L21:09	S04:35	S22:10	M03:48:50	61:18:50	64:08:40	12
1270	MAJ	POK.27	D	2050	HANS JEPSEN	5.30	L07:55	L21:08	S04:25	S23:25	M05:24:31	62:54:31	64:18:06	13
1236	TYKKE BERTHA	BLDINA	D	6	IB CHRISTIAN PEDERSEN	5.05	L06:56	L21:11	S05:10	M00:40	M07:12:57	64:42:57	65:07:41	14
1255	LANUTI	GRAN767	D	19	LAU KRUSE PETERSEN	5.70	L07:22		S05:00	S23:25	M04:55:49	62:25:49	65:15:39	15
1243	BRUNET	DUETTA	D	115	LARRY GERSDAM	5.75	L06:50	L20:58	S04:05	S19:55	M02:56:31	60:26:31	65:26:30+2	16
1257	PANAKEIA	GRAN767	D	25	PETER VOLDSSGAARD	5.80	L08:45	L21:08	S04:26	S23:25	M04:53:03	62:23:03	65:33:06	17
1249	GEDINA	FANT.27	D	911	FLORBOE/PEDERSEN	5.70	L07:04		S04:11		M03:26:58	60:56:58	65:46:48+2	18
1234	ISIS	AVA245	D	163	TORBEN NIELSEN	5.50	L07:24		S04:40	S23:40	M06:14:55	63:44:55	65:52:45	19
1265	KLØVER	MAXIMAG	D	172	JOHNNY BENGTTSSON	6.00	L06:24	L21:08	S03:37		M02:44:11	60:14:11	66:03:10+2	20
1245	VICTORIA II	DUETTA	D	400	IVAN JENSEN	5.70	L07:12		S05:25		M07:12:56	64:42:56	67:32:46	21
1248	TOSSE-TØSEN	FANT.27	D	651	JOHNNY NILSSON	5.75	L07:43		S05:31		M07:34:55	65:04:55	68:04:54	22
1247	LA VIE	FANT.27	D	532	STEEN BERTELSEN	5.75	L07:55		S05:38	M01:05	M07:39:44	65:09:44	68:09:43	23
1258	HUMLEKARRET	JOU.760	D	165	JIMMY JOHANSSON	5.65	L09:00		S05:38		M08:42:09	66:12:09	68:51:41	24
1246	PIJETO	ELV.1/4	D	647	JENS HOLM	6.35	L08:40			S23:45	M06:59:19	64:29:19	69:22:11	25
1237	BELAVI	C.H. 24	D	6	JØRGEN VIBE	5.25	L09:35		S05:00	M01:30	M09:03:20	66:33:20	69:45:28+2	26
1241	GOØT-NOK	DRA.24	D	46	MOGENS PERSSON	5.50	L09:15		S05:33	M03:40	M10:37:45	68:07:45	70:15:35	27
1252	TJØRNEVIK	GIB.76	D	13	ROLF PERSSON	5.50	L09:20				M10:56:53	68:26:53	70:34:43	28
1271	LUMUMBA	TINY	D	13	JØRN DAHL SØRENSEN	5.85	L09:15		S05:30	M04:00	M10:59:15	68:29:15	71:49:13	29
1244	KRØLLE	DUETTA	D	132	JAN BJØRK PETERSEN	5.70					UDGÅET			
1256	JUANITA	GRAN767	D	22	OLE VIBE	5.80	L06:37		S05:00	M01:00	UDGÅET			
1269	LERCHEN	POK.27	D	82	KELD HANSEN	5.10	L07:36	L21:14	S05:34		UDGÅET			
1235	BALSAM	BLDINA	D	3	PALLE WENDELBOE	5.60					IKKE STARTET			
1240	DEN NIHALEDE KA	DRA.24	D	9	OLE STAMPE RASMUSSEN	5.65					IKKE STARTET			
1242	HOBITTEN	DRA.24	D	141	STEEN NORUP ANDERSEN	5.60					IKKE STARTET			
1254	KRAKA	GRAN767	D	8	HENRIK JUL HANSEN	5.40					IKKE STARTET			
1261	JOSKO	MAXIMAG	D	50	PER JOHANSEN	6.00					IKKE STARTET			

RESULTATLISTE SJÆLLAND RUNDT 1988

9. START FREDAG 14:30 BANE 1 - GENNEM GRØNSUND

236 SØMIL

LØB 79 DH 4.95 - 8.90 (STORE MOTORSEJLERE M.M.)

NR.	BÅDNAVN	TYPE	SEJLNR	BÅDENS FØRER	MÅL	ODDEN	AGERSØ	SKANSE	SALTH.	HELSINGØR	SEJLTID	POINTTID	PLAC	
1301	SEA QUEEN	SY.C41	D	41	TORGNY PAHLE	8.90	L02:35	L11:50	F17:17	S08:00:16	41:30:16	52:12:13	PR 1	
1291	NAF ORUST	NAJ.360	S	79	BO LENNSTRÖM	6.70	L04:15		L19:48	S13:04:06	46:34:06	52:25:58	PR 2	
1274	ANACONDA	COL.451	D	2	JAN KLINTEGÅRD	8.55	L03:15	L12:25	L17:50	S09:36:19	43:06:19	53:09:27	PR 3	
1275	ZEPHYRUS	ELV.38	D	1	NIELS HOVE	6.40	L04:10		L21:30	S08:26	S15:14:03	48:44:03	53:45:39	PR 4
1276	DELIGHT	ELV.38	D	28	NELS BJERREGAARD	7.15		L20:55	S03:15	S19:45	S13:53:04	47:23:04	54:24:36	PR 5
1277	OLIVIA J.	ELV.38	D	31	NIELS OVE JUNGENSEN	7.25	L04:58	L15:34	L20:40	S07:05	S14:29:23	47:59:23	55:15:33	PR 6
1283	CAPIA III	HR.42	D	154	POUL MARTIN KROGH JENSEN	7.35		L17:15	L22:14	S08:31	S15:47:38	49:17:38	56:48:07	PR 7
1281	BUTTERFLY	HR.352	D	55	FLEMMING GOTTSCHALK	6.00	L06:46	L20:50	S03:10	S19:30	M01:24:47	58:54:47	62:43:46	8
1296	LISE	RASM35	D	243	KAI CHRISTENSEN	6.05	L05:46				M01:43:23	59:13:23	63:11:51	9
1303	THOP IV	VINDØ65	D	37	H. O. PEDERSEN	6.40	L07:55	L20:55	S03:20	S19:35	M01:16:41	58:46:41	63:48:17	10
1288	LUCKY GIRL	NAJ.320	D	9	LEIF DUE	6.25	L07:07	L20:55	S03:15		M01:49:23	59:19:23	63:54:33	11
1286	JOSEPHINE	MON.31	D	640	UFFE CLEMMENSEN	5.45	L07:24	L21:09	S04:40	S23:35	M05:43:43	63:13:43	65:10:41	12
1780	VAPOR	ELV. 38	D	37	GUNNAR SKJERAN	7.20	L07:09	L20:45			M00:40:19	58:10:19	65:19:12	13
1292	PIA II	NAJ.440	D	1	JEGVAN NIELSEN	8.20	L06:41	L17:40	L23:26	S15:07	S22:40:28	56:10:28	65:32:25	14
1290	ANDREA	NAJ.343	D	109	SØREN RANFELT	6.50	L07:09	L20:50	S03:15		M02:48:32	60:18:32	65:37:15	15
1287	WAVE DANCER	MON.31	D	696	H. ULLMANN	4.95	L06:43		S05:35	M01:35	M08:34:06	66:04:06	66:04:06	16
1259	MARIANNE V	MALØ 10	D	139	KNUD ERIK ANDERSEN	6.90	L07:00	L20:45	S04:40	S20:30	M02:53:21	60:23:21	66:47:00	17
1295	ONDINE	RASM35	D	165	STEEN BOCK	6.15	L09:45	L20:55	S03:37	S20:30	M03:27:43	60:57:43	67:14:45+2	18
1302	FRANSISKA	TAR.96	D	141	RENÉ ENEMARK	6.15	L09:25		S04:55		M07:01:34	64:31:34	68:48:36	19
1297	ELSE DUE	RASM35	D	468	H TANGAA HANSEN	6.05	L09:30		S05:47		M07:37:05	65:07:05	69:05:33	20
1289	SAFARI II	NAJ.34	D	179	FINN CHRISTENSEN	6.20	L09:35		S05:34		M08:54:29	66:24:29	70:50:39	21
1282	CÆCILIA	HR.38		57	PREBEN CEDERQUIST	6.70			S05:10		M07:48:51	65:18:51	71:10:43	22
1650	TAI-PAN	BLUE.38	D	1	BENT HOLM PEDERSEN	5.60	L09:30	S05:05		M04:30	M11:18:21	68:48:21	71:17:27	23
1293	MÄCKLER II	NAUT.43	D	69	KAJ MÄCKLER	7.60	L07:20		S05:30		M05:43:48	63:13:48	71:18:56	24
1279	ROBIN HOOD	FINS38	D	26	OSCAR SUNDWALL	5.85	L09:20		S09:35	M04:30	M10:53:43	68:23:43	71:43:41	25
1273	LYDIA	ALB.SIN	D	60	HENNING SØRENSEN	6.30	L09:55		S10:12	M04:00	M09:53:40	67:23:40	72:07:43	26
1278	MORNING WIND	FINS38	D	11	MOGENS KAILOW	6.10	L12:00				UDGÅET			
1285	JOY	MARIN95	D	28	BJØRN KNUDSEN	5.95	L08:30		S04:30		UDGÅET			
1272	RAMONA	ALB.SIN	D	54	STEFFEN FRØLICH	7.15					IKKE STARTET			
1280	JULE	GERM.40	G	2698	GEORG HOFMANN	7.40					IKKE STARTET			
1284	GITTE	HR.42	D	159	ERIK HEY	7.75					IKKE STARTET			
1294	SAUTERNES	NAUT38	D	220	MICHAEL OLSEN	5.75					IKKE STARTET			
1298	BERIKO III	RASM35	D	470	ERIK OTTO OLSEN	6.00					IKKE STARTET			
1304	ANNE-SHIPCO	ARÖ-J.	R		ØDE ARNE SIMONSEN	7.05					IKKE STARTET			

LØB 80 DH 5.35 - 10.00 (ÆLDRE KUTTERTYPER)

NR.	BÅDNAVN	TYPE	SEJLNR	BÅDENS FØRER	MÅL	ODDEN	AGERSØ	SKANSE	SALTH.	HELSINGØR	SEJLTID	POINTTID	PLAC	
1308	MARGARET	8.M R	D	4	FINN CARLSEN	8.10	L01:50	L10:37	L16:15	S06:19:55	39:49:55	48:59:38	PR 1	
1318	SWIFT	KUTTER	D	55	LARS SCHALDEMOSE	6.80	L04:14	L14:06	L19:16	S12:01:15	45:31:15	51:39:10	PR 2	
1321	AQUAVIT	SK.KRYD	D	136	KAJ R. HANSEN	6.35		L14:06	L19:40	S13:23:52	46:53:52	51:46:44	PR 3	
1320	CYNARA	N.KRYD	D	55	PER HENRIK HANSEN	5.80	L05:39		L21:24	S08:00	S15:09:50	48:39:50	51:49:53	PR 4
1300	FREJA	SPGAT.	D	136	HENRIK ASBO	5.60	L07:27	L20:45	S03:27		M02:17:34	59:47:34	62:16:40	5
1319	DROT	N.KRYD	D	36	TORSTEN THORUP	6.25	L06:50		S03:25		M01:39:59	59:09:59	63:45:09	6
1306	COLETTE	8.M	D	8	MARTIN BONNEN	7.00			S03:30	S19:35	M00:56:36	58:26:36	65:05:38	7
1310	EROBREREN	HAVSØRN	D	301	HANS E. JENSEN	6.40	L08:20		S05:00		M05:26:18	62:56:18	67:57:54	8
1307	ATTILA	8.M CR			J. HOFFMEYER	9.00	L06:56	L20:55		S19:50	M01:27:53	58:57:53	69:50:32	9
1322	TJALDUR	SLOOP	D	29	JENS STORGAARD	6.15	L08:01	L21:10	S05:26	M01:25	M08:12:00	65:42:00	69:59:02	10
1309	CAPELLA	CAPRIC	D	3	JOHN PETERSEN	5.60	L06:46	L20:57	S07:35	M04:30	M10:29:00	67:59:00	70:28:06	11
1299	SØGLAD	SPGAT.	F		N. K. LAURSEN	6.75	L10:25	S11:50			M16:15:01	73:45:01	79:44:57	12
1305	ZENTA	8.M	D	1	REX THOMSEN	5.75	L07:55		S04:40		UDGÅET			
1317	KRISTINA	KUTTER	D	4	OLE HEGELUND	6.80	L09:35		S04:40		UDGÅET			
1695	CATJANA	PLATG.	D	1	OVE SVERKER NILSSON	5.55	L08:30		S05:25		UDGÅET			
1316	WILD TING	KUTTER	D	2	LARS MONDORF	7.00	L07:43	L21:05		S23:35	DISKVALIFICERET			
1314	TYCOON	KUTTER			ULRIK BAY-SCHMITH	7.00					IKKE STARTET			
1315	PIL	KUTTER			STEEN BULLER BYRGESEN	5.35					IKKE STARTET			
1323	ELSEBETH	SLOOP	D	114	TOMMY NORDFALK	6.40					IKKE STARTET			

RESULTATLISTE SJÆLLAND RUNDT 1988

10. START FREDAG 15:00 BANE 1 - GENNEM GRØNSUND

236 SØMIL

LØB 82 SHIPMAN 28

NR.	BÅDNAVN	TYPE	SEJLNR	BÅDENS FØRER	MÅL	ODDEN	AGERSØ	SKANSE	SALTH.	HELSINGØR	SEJLTID	POINTTID	PLAC
1327	QUINTUS	SHI.28	D 149	JENS OLE HESTBÆK	5.90	L06:09	L16:45	L21:54	S08:46	S16:29:01	49:29:01	52:46:18	PR 1
1328	LASTEN	SHI.28	D 249	STEEN WILHELMSEN	5.90	L06:26	L20:53	S03:50	S19:35	M01:44:14	58:44:14	62:01:31	PR 2
1334	TONI	SHI.28	D 4771	TORBEN D HANSEN	5.90	L07:16	L21:06	S03:37	S19:35	M01:53:13	58:53:13	62:10:30	PR 3
1326	ARTEMISIA	SHI.28	D 139	HOLST/THORSEN	5.95	L06:32	L20:54	S03:54		M03:21:30	60:21:30	63:48:28	4
1330	LURSI	SHI.28	4549	JOHANNES JENSEN	5.90	L23:31	L21:08	S04:05		M03:39:35	60:39:35	63:56:52	5
1324	DORTE II	SHI.28	D 61	ALLAN MAHLER	5.90	L07:07		S05:00	S21:30	M03:42:51	60:42:51	64:00:08	6
1333	SUNFLOWER	SHI.28	D 4699	JOHN GRØNSUND	5.90	L06:32		S04:16	S19:30	M02:37:11	59:37:11	64:54:28+2	7
1335	WHITE LADY	SHI.28	D 4781	KURT R. WAGNER	5.90			S04:35	S23:35	M05:54:36	62:54:36	66:11:53	8
1331	ANE	SHI.28	D 4647	HENNING BERGMANN	5.95			S04:50	S23:35	M06:00:10	63:00:10	66:27:08	9
1329	NITTAN	SHI.28	D 250	JESPER SØRENSEN	5.90	L09:20		S05:07	S23:45	M07:43:16	64:43:16	68:00:33	10
1332	FJAB	SHI.28	D 4671	BENT RASMUSSEN	5.90	L09:35		S05:25	M00:30	M07:49:17	64:49:17	68:06:34	11
1325	SHIPMATE	SHI.28	D 71	JENS WULFF	5.90								IKKE STARTET

LØB 83 ACCENT 26 (STANDARD)

NR.	BÅDNAVN	TYPE	SEJLNR	BÅDENS FØRER	MÅL	ODDEN	AGERSØ	SKANSE	SALTH.	HELSINGØR	SEJLTID	POINTTID	PLAC
1338	CAT	ACC.26	150	JENS RÖNNOW	5.65	L05:49	L16:45	L22:00	S09:50	S16:15:22	49:15:22	51:42:26	PR 1
1343	KLAPMYDSEN	ACC.26	D 519	OLE RØDER	5.65	L06:34	L20:55	S03:59	S19:35	M01:23:58	58:23:58	60:51:02	PR 2
1342	TEQUILA	ACC.26	D 471	J. MALTBÆK	5.65	L07:16			S19:45	M02:10:02	59:10:02	61:37:06	3
1341	VIP	ACC.26	D 302	TORBEN AAEN	5.65	L07:18		S04:05	S20:00	M03:13:30	60:13:30	62:40:34	4
1340	FOGGY	ACC.26	251	MATS BURLE	5.65		L20:57	S04:10		M03:22:23	60:22:23	62:49:27	5
1337	VEDETTE	ACC.26	D 130	HANS WALLIND	5.65	L07:39	L21:08	S04:26		M05:56:48	62:56:48	65:23:52	6
1339	PARTOUT	ACC.26	D 226	PAUL ROCHAT	5.65	L05:59	L17:22	S05:08	M00:05	M06:36:40	63:36:40	66:03:44	7
1336	LADY DAY	ACC.26	S 79	STEN DAHLVID	5.65	L09:15		S10:10	M04:30	M11:59:07	68:59:07	71:26:11	8

LØB 84 BANDHOLM 27

NR.	BÅDNAVN	TYPE	SEJLNR	BÅDENS FØRER	MÅL	ODDEN	AGERSØ	SKANSE	SALTH.	HELSINGØR	SEJLTID	POINTTID	PLAC
1345	TAU	BAND27	D 60	NIELS THAULOW	5.50	L06:26		L22:34	S09:50	S16:41:14	49:41:14	51:36:35	PR 1
1348	PIL II	BAND27	D 93	ERIK CHRISTENSEN	5.55	L06:50		S03:57		M01:14:16	58:14:16	60:20:19	PR 2
1350	RAPTUS	BAND27	D 131	JØRGEN MARQVART	5.55	L06:41	L20:58	S03:51	S19:30	M02:06:00	59:06:00	61:12:03	3
1349	BIBI	BAND27	D 124	BIRGER SPONHOLTZ	5.50	L07:00		S03:40	S19:35	M02:17:29	59:17:29	61:12:50	4
1344	HUPS II	BAND27	D 38	FRANK LEMB	5.55	L07:55	L21:07	S04:20	S22:30	M04:20:33	61:20:33	63:26:36	5
1353	TØKK	BAND27	D 200	ERNST BECH	5.90	L07:45		S04:55	S21:10	M03:23:33	60:23:33	63:40:50	6
1347	UNGEN	BAND27	D 87	BJARNE RY MADSEN	5.50	L07:07	L21:13	S05:00		M05:59:42	62:59:42	64:55:03	7
1351	DELOS	BAND27	D 161	BENNY ANDRAE	5.75	L08:10		S05:00	S23:25	M05:25:21	62:25:21	65:12:52	8
1352	AINI	BAND27	D 177	NILS POVL HOLM	5.65	L08:10	L21:13	S05:11		M06:17:19	63:17:19	65:44:23	9
1346	HEKIDO	BAND27	D 61	HENRIK MAAG	5.50	L09:50		S05:25	M00:30	M07:34:37	64:34:37	66:29:58	10

RESULTATLISTE SJÆLLAND RUNDT 1988

10. START FREDAG 15:00 BANE 1 - GENNEM GRØNSUND

236 SØMIL

LØB 85 DH 5.10 - 6.40

NR.	BÅDNAVN	TYPE	SEJLNR	BÅDENS FØRER	MÅL	ODDEN	AGERSØ	SKANSE	SALTH.	HELINGSØR	SEJLTID	POINTTID	PLAC
1370	ANKEN	CTSA28	D 1516	KENNETH MÜLLER	5.65	L05:59	L16:30	L21:41	S08:17	S15:00:54	48:00:54	50:27:58	PR 1
1371	SLUF	CTSA28	D 1521	BENT FREDERIKSEN	5.70	L06:06	L16:30	L21:42	S08:13	S15:03:30	48:03:30	50:40:52	PR 2
1360	SANNE	ALB.CUM	D 98	BRØNSHOLM/ØHRGAARD	5.90	L05:49	L16:15	L21:34	S08:16	S14:57:58	47:57:58	51:15:15	PR 3
1359	OUZO	ALB.CUM	D 29	JAN OLUF KRISTENSEN	5.85	L05:59	L16:25	L21:32	S07:55	S15:08:20	48:08:20	51:15:50	PR 4
1374	BLUES AWAY	KELT 29	D 72	JENS MYGIND	6.15	L05:11	L15:34	L20:54	S07:15	S14:12:26	47:12:26	51:17:00	PR 5
1378	KAREN CUT	L 27	D 11	SVEN ERIK NIELSEN	5.80	L05:56	L16:35	L21:43	S08:23	S15:21:27	48:21:27	51:19:02	PR 6
1367	VERONIKA	BEAS31	D 323	PALLE SØRENSEN	5.95	L06:23	L16:50	L21:50	S08:47	S15:13:17	48:13:17	51:40:15	PR 7
1384	COSTA CHORTAN	PLAY.31	S 70	FREDRIK AXBORN	6.15	L05:49	L16:20	L21:33	S08:00	S14:52:44	47:52:44	51:57:18	PR 8
1396	RØDE ROSA	UFO.31	D 70	SKOVLUND/ LANGBJERG	6.25	L05:46	L16:10	L21:27	S08:00	S14:41:58	47:41:58	52:04:40	PR 9
1364	HÅLLIDEJ	BEAS31	S 29	JAN LINDAHL	6.00	L06:09	L16:45	L21:50	S08:46	S15:53:34	48:53:34	52:30:05	10
1372	SUNRISE	FIRS29	D 1090	S.E. CASPARIJ/ E. BISGÅRD	6.25	L05:52		L21:45	S08:49	S15:08:07	48:08:07	52:30:49	11
1395	BABUSKA	UFO.31	D 52	BJARNE CARLSEN	6.25		L16:15	L21:39	S08:33	S15:34:33	48:34:33	52:57:15	12
1380	MAM*SEL	MAMBA29	D 214	HENNING MØLLER NIELSEN	6.05	L06:26	L17:18		S09:55	S17:41:45	50:41:45	54:27:45	13
1379	ISBJØRNEN	L 27	D 14	SØREN PEDERSEN	6.05	L05:59		L22:40	S11:50	S18:54:19	51:54:19	55:40:19	14
1376	WILD TING	L 27	D 1	ULRIK TANDERUP	5.80	L06:20	L17:40	L23:05	S14:19	S22:12:12	55:12:12	58:09:47	15
1357	BLONDIE	ALB.CIR	S 424	HANS ÅKESSON	5.15	L07:12	L21:00	S04:10	S23:50	M01:34:05	58:34:05	59:10:23	16
1389	BLUE OYSTER	SUNW.27	D 671	PETER MATZEN	5.50	L07:04	L20:56	S04:07	S19:35	M02:37:06	59:37:06	61:32:27	17
1382	BOTTOMS UP	MAXI87	D 340	JØRGEN BJØRCK ANDERSEN	6.00	L06:43	L20:58	S03:20		M01:07:26	58:07:26	61:43:57	18
1362	UTOPIA	ANTIL	D 526	ERLAND JENSEN	6.00	L06:53	L20:53	S04:05	S23:50	M01:20:16	58:20:16	61:56:47	19
1381	SAMBA	MAMBA29	D 227	KELD BLYNOV	6.15	L07:12		S03:57	S19:40	M01:21:40	58:21:40	62:26:14	20
1393	M-STYLE	SUNW.31	D 151	STEEN BILLE	6.15	L07:27	L21:00	S03:57	S19:30	M01:30:59	58:30:59	62:35:33	21
1369	JACKPOT	CTSA28	D 1513	DAN BØRRESEN	5.70		L20:55		S19:35	M01:30:22	58:30:22	63:07:44+2	22
1356	MARE II	ALB.CIR	D 237	OLLE LINDSKOG	5.20	L06:26	L21:00	S05:11		M05:32:47	62:32:47	63:20:50	23
1354	PIATINE	ALB.CIR	D 20	GEORG L. SMIDT-JENSEN	5.25	L07:26		S04:26		M05:34:16	62:34:16	63:33:56	24
1365	NOBUKO	BEAS31	D 69	ERIK BONDE ANDERSEN	6.10	L07:32	L21:08	S04:19	S23:45	M02:54:35	59:54:35	63:49:54	25
1387	KIJAMO	SUNW.27	D 655	MOGENS KINDBERG	5.50	L07:35		S04:55	S23:25	M05:17:18	62:17:18	64:12:39	26
1358	NIKE	ALB.CIR	D 452	PETER KROGSGAARD	5.20	L07:09	L21:15	S05:05		M06:29:03	63:29:03	64:17:06	27
1390	KARIN N	SUNW.27	D 675	FRANK JOHANSSON	5.50	L08:15	L21:00	S04:14	S23:25	M05:25:01	62:25:01	64:20:22	28
1361	DUET	ALB.CUM	D 147	JØRN THAARUP	5.90	L06:37	L20:55		S19:45	M02:12:50	59:12:50	64:30:07+2	29
1355	ROSITA	ALB.CIR	D 86	KENNETH SKOVBY RASMUSSEN	5.30	L07:43	L21:00	S04:55		M06:23:48	63:23:48	64:34:54	30
1391	QUINDE MIN	SUNW.31	D 125	JØRGEN FISCHER	6.20	L07:48	L21:00	S04:00	S21:50	M03:30:09	60:30:09	64:43:51	31
1388	HEFI	SUNW.27	D 662	FINN STRANDHOLDT	5.65	L07:36		L22:34	S23:25	M05:33:14	62:33:14	65:00:18	32
1385	BABUSHKA	SMILING	D 2	OVE SØNDERGÅRD	5.60	L07:30		S05:00	S23:35	M05:45:16	62:45:16	65:01:54	33
1392	SECOND TO NONE	SUNW.31	D 138	JONNA ANDERSEN	6.00	L07:00		S05:07	S21:35	M02:49:52	59:49:52	65:26:23+2	34
1366	SALLY SØE	BEAS31	D 268	MICHAEL SØE KRISTENSEN	6.10	L07:22	L21:08	S04:17		M03:56:41	60:56:41	66:52:00+2	35
1377	ILENA	L 27	D 8	BENNY SKOURUP	5.95	L07:48		S04:40	S23:30	M06:46:27	63:46:27	67:13:25	36
1386	GAMBA	SMILING	D 150	NIELS OLUF HANSEN	6.15	L07:04	L21:14	S05:14	M00:15	M06:31:49	63:31:49	67:36:23	37
1397	ZETA RATTUS	WILL31	D 43	OLE STARKLINT	6.05	L08:10	L21:11	S04:40	M00:05	M07:02:10	64:02:10	67:48:10	38
1368	HENISA	COL.86		OVE CHRISTENSEN	6.20			S05:07	S23:50	M06:39:34	63:39:34	67:53:16	39
1363	SØS IV	BAND30	D 8	OLE OLSEN	5.10	L12:00		S11:07	M04:45	M12:13:19	69:13:19	69:37:39	40
1383	TUT III	MIST.32	D 87	ERIK EGSDAL	5.85	L09:30		S06:13		M11:17:22	68:17:22	71:24:52	41
1375	LA VIE	KELT 29	D 73	VILLY NIELSEN	5.75	L08:50	L21:15	S05:44		UDGÅET			
1394	TAUERLAB	SUNW311	D 154	HASSE VINTER	6.30					IKKE STARTET			
1782	FREEDOM	KUTTER	D 210	JOHNNI OLSEN	5.30					IKKE STARTET			

LØB 86 DH 5.00 - 7.00

NR.	BÅDNAVN	TYPE	SEJLNR	BÅDENS FØRER	MÅL	ODDEN	AGERSØ	SKANSE	SALTH.	HELINGSØR	SEJLTID	POINTTID	PLAC
1409	NULLER II	MAXI84	D 623	RENATO SKOV	5.70	L05:59		L21:49	S08:31	S15:24:14	48:24:14	51:01:36	PR 1
1400	DRÖHNBÜTEL	DUF1800	G 46	WALTER HUNEKE	5.10	L08:30	L21:10			M01:49:01	58:49:01	59:13:21	PR 2
1412	BUMBLE BEE	MAXI84	D 1065	HENNING PEDERSEN	5.55	L07:09			S19:05	M00:52:52	57:52:52	59:58:55	PR 3
1407	LOSSE	MAXI84	D 86	EGON NIELSEN	5.55	L07:04		S03:54	S19:35	M01:16:36	58:16:36	60:22:39	PR 4
1399	SKRÆP	DRA.25	D 1	PREBEN LEENDERS	5.45	L06:52	L21:00	S04:14	S20:10	M02:18:36	59:18:36	61:03:06	PR 5
1413	JL SPIRIT	OHL.29	D 428	CARL WEGEBERG	6.00	L06:51	L20:50	S03:20	S19:25	M01:13:17	58:13:17	61:49:48	PR 6
1411	TULLE	MAXI84	D 669	OLE PEDERSEN	5.55	L07:33		S04:14	S21:10	M03:05:27	60:05:27	62:11:30	7
1410	JOHANNE II	MAXI84	D 649	ANDERS SERUP-HANSEN	5.55	L06:36		S04:26		M03:32:58	60:32:58	62:39:01	8
1417	TJALFE	SAL.26	D 33	PETER INGEMANN	6.05	L06:46	L21:00	S04:11	S21:35	M03:09:11	60:09:11	63:55:11	9
1408	MY DREAM	MAXI84	D 443	TOM SCHAMAITAT	5.60	L06:51	L21:05	S04:27	S21:50	M03:29:02	60:29:02	64:45:40+2	10
1422	HEIDI	TRIO80	D 12	ANKJÆR / FANEFJORD	5.70	L07:00	L21:05	S04:14	S23:25	M05:09:23	62:09:23	64:46:45	11
1421	CAMITA	TRIO80	D 10	PER DAVIDSEN	5.60	L08:15	L21:05	S04:27		M05:53:03	62:53:03	65:09:41	12
1423	KRUKKE DILLE	TRIO80	D 229	SØREN LINDSTRØM	5.70	L08:30		S04:35		M05:50:02	62:50:02	65:27:24	13
1404	MAK-SEA-MA	MAXI777	D 5	LEIF HENRIKS	5.65			S04:35	S23:35	M06:09:58	63:09:58	65:37:02	14
1418	REDUCE	SAL.26	D 34	JOHN BONNOR	5.80	L07:00	L21:00	S04:06		M03:43:11	65:43:11	65:40:46+2	15
1416	AYUMI	SAL.26	D 29	STIG MYLER THOMSEN	6.05		L20:50	S04:40	S23:35	M05:47:03	62:47:03	66:33:03	16
1401	KILO	DUF27	D 19	KIM RASMUSSEN	5.75	L09:05		S05:19	M00:00	M07:19:56	64:19:56	67:07:27	17
1402	GONZO	GRAN23	D 10	MORTEN ULRIK MATHIESEN	5.40	L09:05		S05:44	M01:05	M08:40:55	65:40:55	67:14:27	18
1403	HELLE	MAXI77	D 3035	EDVIN REINØ	5.05	L06:20		S10:50	M04:30	M11:15:00	68:15:00	68:27:16	19
1398	BA-LI	C.C.27	D 1	ALLAN NIELSEN	5.00	L09:10				UDGÅET			
1405	MAIA	MAXI777	D 26	PETER RANK	5.70	L07:00	L21:06			UDGÅET			
1419	MARIETTE	SUNW.26	D 264	H. JENS CRONE	5.35			S04:45		UDGÅET			
1420	NO HURRY	SUNW.26	D 298	HÅKAN NERBLAD	5.45	L06:24				UDGÅET			
1415	KRAKA	SAL.26	D 3	P. H. SMIDT	5.85	L06:56	L21:08	S03:57	S20:40	DISKVALIFICERET			
1406	TIPSY II	MAXI777	D 36	GØRAN LINDQVIST	5.70					IKKE STARTET			
1414	SOFFY	PA 28	D 178	JOS HARTVIG JØRGENSEN	7.00					IKKE STARTET			

RESULTATLISTE SJÆLLAND RUNDT 1988

10. START FREDAG 15:00 BANE 1 - GENNEM GRØNSUND

236 SØMIL

LØB 87 DRABANT 27

NR.	BÅDNAVN	TYPE	SEJLNR	BÅDENS FØRER	MÅL	ODDEN	AGERSØ	SKANSE	SALTH.	HELSINGØR	SEJLTID	POINTTID	PLAC
1424	LIF	DRA.27	D 19	LEIF ERIKSEN	5.90	L05:11	L15:37	L21:01	S07:30	S14:41:15	47:41:15	50:58:32	PR 1
1426	LAZY ACE	DRA.27	D 42	IB JØRGENSEN	5.90	L05:46	L16:15	L21:32	S08:44	S16:17:11	49:17:11	52:34:28	PR 2
1428	HAVLIT	DRA.27	D 67	TROELS RAVNHOLT	5.75		L17:35	L22:40		S18:32:21	51:32:21	54:19:52	3
1430	GUDRUN	DRA.27	D 82	KURT PAULSEN	5.80	L06:32	L17:22	L22:30	S10:20	S18:45:49	51:45:49	54:43:24	4
1425	BOMBI	DRA.27	D 32	WERNER PEDERSEN	5.40	L06:24	L17:50	L23:33	S15:05	S22:19:22	55:19:22	56:52:54	5
1429	SYVSTJERNEN	DRA.27	D 71	NIELS KJELDSEN	5.80	L06:46	L20:55	S03:35		M01:11:14	58:11:14	61:08:49	6
1427	RUTLAS	DRA.27	D 62	SVEND AAGE HANSEN	5.75			S04:00	S19:45	M02:56:24	59:56:24	64:43:55+2	7

LØB 88 NAVER 29

NR.	BÅDNAVN	TYPE	SEJLNR	BÅDENS FØRER	MÅL	ODDEN	AGERSØ	SKANSE	SALTH.	HELSINGØR	SEJLTID	POINTTID	PLAC
1435	NICOLINE	NAV.29	D 129	HANS EGMONT	5.85	L07:04	L20:56	S03:35	S19:30	M01:20:19	58:20:19	61:27:49	PR 1
1433	CARI	NAV.29	D 48	FLEMMING PETERSEN	6.10	L07:40		S03:59	S19:55	M01:59:02	58:59:02	62:54:21	PR 2
1436	DIONE	NAV.29	D 165	HELGE CHRISTENSEN	6.10	L07:09		S04:40		M03:24:15	60:24:15	64:19:34	3
1432	MAGDA	NAV.29	D 41	OLE STOKHOLM	6.15	L07:09		S04:16		M03:37:49	60:37:49	64:42:23	4
1434	RØDHJ	NAV.29	D 96	BO HILDEBRANDT	6.05	L08:40		S05:14	M00:55	M07:11:23	64:11:23	67:57:23	5
1437	CHARLIE	NAV.29	D 171	WARNY CORFITZ	6.15	L07:31		S05:00	S23:25	M05:57:27	62:57:27	69:02:01+2	6
1431	AKKI	NAV.29	D 24	KURT JØNSEN	6.30	L09:05		S05:47		UDGÅET			7

LØB 89 DH 5.40 - 6.65

NR.	BÅDNAVN	TYPE	SEJLNR	BÅDENS FØRER	MÅL	ODDEN	AGERSØ	SKANSE	SALTH.	HELSINGØR	SEJLTID	POINTTID	PLAC
1440	PAMULA	NIMB30	D 39	HELMER BERING	6.65	L03:40	L13:25	L17:49		S10:46:42	43:46:42	49:17:57	PR 1
1450	RØD TOP	SOL.29	D 8	KJELD NIELSEN	6.15	L05:33	L15:50	L21:02	S07:35	S14:29:30	47:29:30	51:34:04	PR 2
1442	TØSEN	OHL.8:8		ALEX HJORTNÆS	6.05	L06:22	L17:35	L22:34	S09:25	S15:07:45	48:07:45	51:53:45	PR 3
1451	GARFIELD	SOL.29	D 20	KURT LUNDSBERG	6.25	L06:02	L17:00	L22:20	S08:55	S15:31:33	48:31:33	52:54:15	4
1452	MUSETTE II	SOL.29	D 25	KAI ROZARTH	6.20	L06:22	L17:35	L22:40		S17:18:55	50:18:55	54:32:37	5
1439	OPTIMIST 2	NIMB30	D 27	SVEND KAAE	6.20	L08:40		S03:50	S19:45	M02:47:23	59:47:23	64:01:05	6
1453	CAP	SOL.29	D 38	FINN LARSEN	5.65	L07:04	L21:12	S05:00	S23:30	M05:11:50	62:11:50	64:38:54	7
1449	SARA	SOL.29	D 6	TOM LARSEN	6.20	L06:20	L20:50	S03:51	S20:05	M02:07:00	59:07:00	65:20:42+2	8
1444	EMMA	OMEGA28	158	OLE KNUDSEN	5.80	L07:46	L21:15	S05:00	S23:45	M06:06:12	63:06:12	66:03:47	9
1438	FANNY	HYDRO	D 1	LEIF JACOBSEN	6.25	L08:40		S05:18	S23:30	M05:50:27	62:50:27	67:13:09	10
1443	JETTE	OHL.8:8	D 94	ARNE JESPERSEN	5.80	L07:48	L14:35	S05:27		DISKVALIFICERET			
1441	TURBO	NORD30	D 12	JOHN CHRISTENSEN	6.35					IKKE STARTET			

LØB 90 L.29

NR.	BÅDNAVN	TYPE	SEJLNR	BÅDENS FØRER	MÅL	ODDEN	AGERSØ	SKANSE	SALTH.	HELSINGØR	SEJLTID	POINTTID	PLAC
1460	MORS SKRÆK	L.29	D 130	BENDT DAHL ANDERSEN	5.95	L05:33	L16:05	L21:35	S08:13	S15:08:46	48:08:46	51:35:44	PR 1
1456	KETOS	L.29	D 61	HELLE & SUSANNE JENSEN	6.30	L05:33	L15:55	L21:02	S07:44	S14:32:31	47:32:31	52:04:06	PR 2
1458	TED	L.29	D 114	DIRCH WILLÉN	6.25	L05:39	L16:15	L21:31	S07:55	S16:00:43	49:00:43	53:23:25	3
1455	CARNILL	L.29	D 29	HENNING STILLING	6.25	L05:59	L16:50	L22:20	S10:05	S17:21:56	50:21:56	54:44:38	4
1454	MICCHRIS	L.29	D 15	PER BASTHOLM	6.30	L06:34	L17:55	L23:05		S20:25:58	53:25:58	57:57:33	5
1457	4-THOMMER	L.29	D 67	B. THOMSEN	5.90	L07:07	L20:58	S05:00		M02:57:05	59:57:05	65:14:22+2	6
1459	BØV	L.29	D 116	PREBEN JØRGENSEN	6.25					IKKE STARTET			

RESULTATLISTE SJÆLLAND RUNDT 1988

11. START FREDAG 15:30 BANE 2 - GENNEM BØGESTRØMMEN

215 SOMIL

LØB 92 MAXI 77 (STANDARD)

NR.	BÅDNAVN	TYPE	SEJLNR	BÅDENS FØRER	MÅL	ODDEN	AGERSØ	KALVEH	SALTH.	HELSEINGØR	SEJLTID	POINTTID	PLAC
1468	DUMPE	MAXI77	D 1365	JENS BAK PEDERSEN	5.55	L06:37		S04:00	S17:15	S23:17:36	55:47:36	61:35:58	PR 1
1479	JESCO	MAXI77	D 2097	B. JESPERSEN	5.55	L07:12		S04:05		S23:28:45	55:58:45	61:47:07	PR 2
1473	SMOKELESS	MAXI77	D 1445	MORTEN B. PEDERSEN	5.55	L07:55	L21:00	S03:50	S17:25	S23:54:12	56:24:12	62:12:34	PR 3
1488	SERVUS	MAXI77	D 2772	ROBERT BUDIK	5.55	L07:00		S04:25		M00:04:06	56:34:06	62:22:28	PR 4
1466	TRUNTE	MAXI77	D 996	JOHN SØRENSEN	5.55	L07:38		S04:15	S17:50	M00:13:21	56:43:21	62:31:43	PR 5
1494	MANTO	MAXI77	D 3720	JENS HANSEN	5.55	L07:22		S04:10	S17:55	M00:14:33	56:44:33	62:32:55	PR 6
1489	ARCHIMEDES	MAXI77	D 2802	SØREN THOMASEN	5.55	L09:30		S05:05	S19:25	M01:30:35	58:00:35	63:48:57	PR 7
1463	TRUE LOVE II	MAXI77	D 341	PETER PALUDAN	5.55	L08:55		S04:30	S19:20	M01:44:50	58:14:50	64:03:12	8
1462	LISBETH	MAXI77	D 318	ERIK BELL	5.55	L08:40			S19:25	M01:48:14	58:18:14	64:06:36	9
1484	VETO	MAXI77	D 2460	HENRY S. ANGELO	5.55	L08:20			S19:45	M01:50:04	58:20:04	64:08:26	10
1476	TINA	MAXI77	D 1987	JOHN JØRGENSEN	5.55	L07:34	L11:35	S04:30		M01:50:39	58:20:39	64:09:01	11
1480	CHRISTINA	MAXI77	D 2263	OLE PEDERSEN	5.55	L07:48	L20:58	S05:25	S19:40	M01:51:10	58:21:10	64:09:32	12
1492	EIRENE	MAXI77	D 3026	H. G. KRISTENSEN	5.55	L07:43		S04:55	S19:35	M01:53:47	58:23:47	64:12:09	13
1481	MOMSEMOR	MAXI77	D 2274	HANS EGEBO	5.55	L07:24		S04:10		M01:53:48	58:23:48	64:12:10	14
1471	TAMARA	MAXI77	D 1411	JENS OLE KIRKEGAARD	5.55	L07:48		S04:20	S19:40	M01:55:25	58:25:25	64:13:47	15
1486	MILLE	MAXI77	D 2499	H. CHR. HANSEN	5.55	L08:45	L21:11	S05:45	S19:45	M02:06:22	58:36:22	64:24:44	16
1469	SPRAY	MAXI77	D 1370	BØRGE JENSEN	5.55	L06:56		S04:20	S19:35	M02:15:20	58:45:20	64:33:42	17
1467	TINICA	MAXI77	D 1112	JOHN CHRISTIANSEN	5.55	L08:01		S04:50	S19:50	M02:17:03	58:47:03	64:35:25	18
1464	MAXICAT	MAXI77	D 459	JAN LYNGGAARD	5.55	L09:00		S05:15	S19:55	M02:43:33	59:13:33	65:01:55	19
1485	RELEX	MAXI77	D 2470	CLAUS JENSEN	5.55	L08:45		S04:40	S19:55	M02:58:46	59:28:46	65:17:08	20
1472	KRØLLE-BØLLE	MAXI77	D 1439	HANS-ERIK THORSEN	5.55	L08:01		S04:20	S19:40	M03:20:24	59:50:24	65:38:46	21
1477	MOSSLE	MAXI77	D 2029	THOMAS LUNDQVIST	5.55	L08:45	L21:05	S04:25	S19:55	M03:38:38	60:08:38	65:57:00	22
1478	PARODOKS	MAXI77	D 2075	KJELD HANSEN	5.55	L09:05		S04:20	S19:45	M02:16:05	58:46:05	66:34:27+2	23
1475	LAGUNA	MAXI77	D 1822	SVEND OLSEN	5.55	L07:48		S04:25	S20:25	M02:37:50	59:07:50	66:56:12+2	24
1493	ATHENE	MAXI77	D 3573	ROLF GUNDERSEN	5.55	L07:48		S05:10	S19:35	M03:04:15	59:34:15	67:22:37+2	25
1461	FRED II	MAXI77	D 270	NILS DAMGAARD	5.55	L07:55	L21:10	S04:25	S19:45	M03:12:31	59:42:31	67:30:53+2	26
1465	SIF	MAXI77	D 665	FLEMMING MORTENSEN	5.55	L09:25	L21:08	S04:35	S20:15	M03:15:28	59:45:28	67:33:50+2	27
1482	SHE	MAXI77	D 2307	LARS LORITSEN	5.55	L09:55		S06:25	S23:45	M06:02:45	62:32:45	68:21:07	28
1474	LÆ	MAXI77	D 1466	KARL NØRGAARD	5.55	L08:40		S06:00		M04:53:38	61:23:38	69:12:00+2	29
1470	NANOQ	MAXI77	D 1374	BO BJERREGAARD	5.55	L11:15	L21:06	S09:40	M00:15	M07:31:18	64:01:18	69:49:40	30
1487	VALBORG	MAXI77	D 2644	PETER THOMSEN	5.55	L08:10		S05:40		UDGÆT			
1490	JIMBO	MAXI77	D 2811	HENNING JENSEN	5.55	L12:10	S02:02			UDGÆT			
1491	SATO	MAXI77	D 2981	BJARNE ERIKSEN	5.55	L07:55				UDGÆT			

LØB 93 I.F. KR (ENTYPE)

NR.	BÅDNAVN	TYPE	SEJLNR	BÅDENS FØRER	MÅL	ODDEN	AGERSØ	KALVEH	SALTH.	HELSEINGØR	SEJLTID	POINTTID	PLAC
1512	NANOK	I.F.KR	D 202	NIELS WESTERGÅRD-NIELSEN	5.00	L06:56		S03:40		S22:38:36	55:08:36	59:02:07	PR 1
1523	NO STRESS	I.F.KR	D 286	NIELS FLANDRUP	5.00	L06:41	L20:55			S22:41:36	55:11:36	59:05:07	PR 2
1524	MAIKAT	I.F.KR	D 287	T. RØNNØW	5.00	L06:51		S03:45	S16:40	S22:42:27	55:12:27	59:05:58	PR 3
1504	ISA LEI	I.F.KR	D 65	BO GARNY	5.00	L06:46		S03:50	S16:45	S23:01:24	55:31:24	59:24:55	PR 4
1511	NAUSIKAA	I.F.KR	D 182	SØREN HILLERUP	5.00	L07:33			S16:40	S23:13:06	55:43:06	59:36:37	PR 5
1505	MUTT-PUTT	I.F.KR	D 68	CARSTEN V. CHRISTENSEN	5.00			S03:55		S23:26:39	55:56:39	59:50:10	PR 6
1516	KLYDEN	I.F.KR	D 246	PETER AHRENS	5.00	L07:24		S03:50	S16:50	S23:29:59	55:59:59	59:53:30	PR 7
1508	LISE	I.F.KR	D 138	KENNETH JENSEN	5.00	L08:10		S04:05	S16:55	M00:01:00	56:31:00	60:24:31	8
1498	FREM II	I.F.KR	D 28	CLAUS HILDAN	5.00	L08:30		S04:30		M00:23:45	56:53:45	60:47:16	9
1510	MUFFE	I.F.KR	D 178	HENRIK BLOMDAHL	5.00	L06:56				M00:23:57	56:53:57	60:47:28	10
1497	MASCOT	I.F.KR	D 23	PETER THULSTRUP	5.00	L08:30		S04:10		M00:27:52	56:57:52	60:51:23	11
1496	BEPPER	I.F.KR	D 15	LAUST KRUSE	5.00			S04:10	S19:20	M00:32:15	57:02:15	60:55:46	12
1525	SKOVSER	I.F.KR	D 289	J. GORM HANSEN	5.00	L08:40		S03:35		M00:34:20	57:04:20	60:57:51	13
1521	LEON	I.F.KR	D 275	SVEN ARNE NORDAHL JENSEN	5.00	L08:30		S04:10		M01:03:50	57:33:50	61:27:21	14
1517	JEFFER	I.F.KR	D 247	OLE FREDERIKSEN	5.00	L07:46	L21:08	S04:20	S19:25	M01:17:05	57:47:05	61:40:36	15
1500	ALDUS	I.F.KR	D 38	POUL E. KJELDGAARD	5.00	L07:44	L21:05	S04:50	S19:20	M01:26:23	57:56:23	61:49:54	16
1502	RUBINEN	I.F.KR	D 53	PETER RASMUSSEN	5.00	L09:05		S05:20	S19:25	M01:54:11	58:24:11	62:17:42	17
1514	ELDORADO	I.F.KR	D 225	GERT RØNNE	5.00			S04:15	S19:45	M01:54:50	58:24:50	62:18:21	18
1507	SØS	I.F.KR	D 112	KNUD E DAN	5.00	L08:15		S04:10		M02:06:38	58:36:38	62:30:09	19
1509	TOEREN	I.F.KR	D 150	OLE JUL LARSEN	5.00	L09:30		S04:15	S19:45	M02:09:42	58:39:42	62:33:13	20
1520	HOTPOT	I.F.KR	D 271	KNUD ERIK NIELSEN	5.00	L09:40		S03:50	S19:50	M02:28:40	58:58:40	62:52:11	21
1522	FIREREN	I.F.KR	D 280	JOHN NILSSON	5.00	L09:20		S03:50	S19:55	M03:40:15	60:10:15	64:03:46	22
1513	PUST II	I.F.KR	D 221	FRITS GARDE	5.00	L08:40		S05:10	S19:35	M01:50:10	58:20:10	64:13:41+2	23
1526	SPLIT	I.F.KR	D 294	SØREN S. ANDERSEN	5.00	L09:25		S04:10		M02:17:53	58:47:53	64:41:24+2	24
1506	CHERIE	I.F.KR	D 108	ULLA RAHF	5.00	L09:00		S05:20	S19:50	M02:54:18	59:24:18	65:17:49+2	25
1501	WILHELM	I.F.KR	D 52	FINN E. JENSEN	5.00					UDGÆT			
1519	ANNA	I.F.KR	D 256	VILLY GROLLOW	5.00	L12:30	S02:04	S10:55	M01:25	DISKVALIFICERET			
1495	ALOPEX	I.F.KR	D 7	JESPER FUCHS	5.00					IKKE STARTET			
1499	AMAZONE	I.F.KR	D 35	BERNHARD KØRBITZ	5.00					IKKE STARTET			
1503	TERNEN	I.F.KR	D 62	ALAN LARSEN	5.00					IKKE STARTET			
1515	DIKKE	I.F.KR	D 228	HANS-HENRIK PARVING	5.00					IKKE STARTET			
1518	JEP	I.F.KR	D 254	JENS CLEEMANN HORS	5.00					IKKE STARTET			

RESULTATLISTE SJÆLLAND RUNDT 1988

11. START FREDAG 15:30 BANE 2 - GJENNEM BØGESTRØMMEN

215 SØMIL

LØB 97 SOLUS 24

NR.	BÅDNAVN	TYPE	SEJLNR	BÅDENS FØRER	MÅL	ODDEN	AGERSØ	KALVEH	SALTH.	HELINGØR	SEJLTID	POINTTID	PLAC	
1586	SUNNY	SOL.24	S	78	CURT LEWIN	5.50			S04:45	M00:05:52	56:35:52	62:14:29	PR 1	
1587	JAWS	SOL.24	D	81	ERIK OLSEN	4.90	L08:45		S05:25	S19:40	M02:20:48	58:50:48	62:21:27	PR 2
1588	SOLUS 111	SOL.24	D	111	OLE SVANHOLM	4.60	L09:00		S05:00		M03:33:47	60:03:47	62:21:40	3
1585	ANINE	SOL.24	D	65	ANDERS ØSTER PEDERSEN	5.50	L07:55		S05:15	S19:35	M01:34:18	58:04:18	63:42:55	4
1589	HAVGASSEN	SOL.24	D	120	NIELS ANDERSEN	5.50	L07:12		S06:40		M01:39:30	58:09:30	63:48:07	5
1590	MATHILDE	SOL.24	D	128	PER BUK	5.50	L08:10	L21:15	S05:05	S19:45	M02:06:03	58:36:03	64:14:40	6
1584	MAC-LAR'S	SOL.24	D	19	KAJ HESS LARSEN	5.50	L08:30		S05:05		M01:43:17	58:13:17	65:51:54+2	7

LØB 98 DH 4.10 - 6.00

NR.	BÅDNAVN	TYPE	SEJLNR	BÅDENS FØRER	MÅL	ODDEN	AGERSØ	KALVEH	SALTH.	HELINGØR	SEJLTID	POINTTID	PLAC	
1602	SABRINA	DARI23	D	10	HENRIK B. LARSEN	4.90	L06:53	L21:00			S22:43:17	55:13:17	58:43:56	PR 1
1614	PISTAICE	NORD666	D	120	PALLE HORNE JENSEN	4.60	L08:20		S04:55		M02:24:24	58:54:24	61:12:17	PR 2
1604	TOPLØS	DRA.21S	D	122	RODOLFO NIELSEN	4.90		L21:11	S04:15	S19:25	M01:34:43	58:04:43	61:35:22	PR 3
1591	CAPRE	ACHIL24	D	122	CARSTEN FERSEV	5.00			S04:55	S19:25	M01:33:30	58:03:30	61:57:01	PR 4
1595	LOUISE	BAND24	D	286	JAN NIELSEN	4.90	L09:05		S05:00		M02:10:58	58:40:58	62:11:37	PR 5
1592	TROJKA	BAND24	D	6	KRISTIAN RAHBEK	4.80	L09:55			S20:00	M02:43:18	59:13:18	62:20:25	PR 6
1615	AMOK	SCAN.22	D	37	CLAUS N. GANTZEL	5.15	L08:30		S03:55	S19:30	M01:45:05	58:15:05	62:41:40	7
1730	TREIN	BAND24	D	18	HENNING RIIS	4.80	L09:15		S05:35		M03:44:47	60:14:47	63:21:54	8
1611	KO-KASSEN	KO 700	D	22	BRIAN ANDERSEN	4.90			S04:10		M01:29:00	57:59:00	63:29:39+2	9
1597	BANANEN	BEL.22	D	37	BRDR. OLSEN	5.10	L08:20		S04:25	S19:50	M03:05:10	59:35:10	63:50:52	10
1598	XANTHIPPE	BOHMIN	D	165	JOHN STJEN-THOMSEN	5.00	L09:40		S06:45	S20:40	M03:52:30	60:22:30	64:16:01	11
1607	HAVBARD	ELV.6.5	D	6	GERT HOLM KRISTENSEN	4.85	L09:10		S06:10		M03:56:56	60:26:56	65:45:54+2	12
1608	CHILIE	ELV.6.5	D	19	ULRIK MOLL	5.00	L09:15		S06:35	S20:40	M04:01:38	60:31:38	66:25:09+2	13
1593	OHANNA	BAND24	S	47	ROLF HÅKANSSON	4.80	L09:10	L23:35	S09:30		M08:00:13	64:30:13	67:37:20	14
1594	ODA	BAND24	D	51	BO CHRISTIANSEN	4.90	L11:05		S09:30	M00:20	M08:05:21	64:35:21	68:06:00	15
1603	KALINKA	DARI23	D	16	PEER RASMUSSEN	4.45	L11:30	S00:40	S12:21	M02:15	M09:58:03	66:28:03	68:06:54	16
1601	MOSTER FI*	COLU.66	D	52	ARNE HANSEN	4.35	L11:25	S01:20	S11:20	M03:40	M11:28:48	67:58:48	69:10:36	17
1600	COLUMBINE	COLU.66	D	9	ERIK HØYBYE	4.10	L13:35	S03:54	S12:53	M04:30	M12:47:43	69:17:43	69:17:43	18
1609	SADIK	HELL.26	D	7	PETER SEITZBERG	4.60	L11:45	S01:55	S12:21	M02:15	M10:37:35	67:07:35	69:25:28	19
1613	BLISHØNEN	LM.22	D	80	HASSE KROLL	5.00	L11:05		S10:40		M09:09:53	65:39:53	69:33:24	20
1616	SANDY	TONIC23	D	958	JØRGEN CHRISTIANSEN	4.95	L11:50	S02:06	S12:21		M10:30:06	67:00:06	70:42:16	21
1599	GRIBBEN	BRIO	D	436	BO HYLLESTED	4.15	L08:10	S03:15	S12:21		M14:20:41	70:50:41	71:05:33	22
1617	BEAGLE SCEPTRE	VARN850			KARL SØRENSEN	5.00		S07:37	S15:40		M14:28:44	70:58:44	74:52:15	23
1612	CIRKELINE	LEI.23	D	425	M. BØJE HANSEN	5.00					UDGÆT			
1596	NILLE	BEL.22	D	29	JØRN CHEMNITZ	4.90		L21:11			DISKVALIFICERET			
1606	MÅGEKLATTEN	EDEL660	D	780	IRENE GOTTSCHALK	4.80		S03:53	S12:48		DISKVALIFICERET			
1605	PERNILLE	DRACO	D	124	JESPER DALBYE	6.00					IKKE STARTET			
1610	MARGRETHE	HUNT.19	D	392	POUL FEILBERG	4.65					IKKE STARTET			

LØB 99 DH 4.85 - 5.55 (GRAN.24/TUR.84)

NR.	BÅDNAVN	TYPE	SEJLNR	BÅDENS FØRER	MÅL	ODDEN	AGERSØ	KALVEH	SALTH.	HELINGØR	SEJLTID	POINTTID	PLAC	
1619	SAGITTA	GRAN24	G	39	FRANK TILLMANN	5.40	L07:35	L21:05	S04:00	S17:00	S23:26:05	55:56:05	61:14:49	PR 1
1625	FRAM	TUR.84	D	168	JØRGEN BURFELT	5.55	L08:20		S03:55	S16:55	S23:10:30	55:40:30	61:28:52	PR 2
1624	DAPHNE	GRAN24	D	376	UFFE VILLUMSEN	5.35	L08:10		S04:15	S19:45	M01:55:52	58:25:52	63:34:27	3
1620	CHERIE	GRAN24	D	91	BENT JENSEN	5.35	L08:40		S05:25	S19:40	M02:00:49	58:30:49	63:39:24	4
1622	NUSER	GRAN24	D	263	KELD REENBERG HANSEN	5.40	L09:10		S05:45	S20:40	M03:32:25	60:02:25	65:21:09	5
1627	SJANNETTE	TUR.84	D	281	LEIF WÆBER	5.40	L10:55	L22:40	S09:45		M09:07:31	65:37:31	70:56:15	6
1626	MALOU	TUR.84	D	192	ARNE KNUDSEN	5.40	L13:25	S03:24	S12:21	M02:15	M10:11:30	66:41:30	72:00:14	7
1618	BELLE	FIRS.24	D	40	LARS F. HANSEN	4.85	L14:15	S06:25	S14:45		UDGÆT			
1623	MJØLNER	GRAN24	D	338	JAN NIELSEN	5.40	L08:45				UDGÆT			
1621	VARANEN II	GRAN24	D	183	HELGE USSING	5.45	L11:45				DISKVALIFICERET			

RESULTATLISTE SJÆLLAND RUNDT 1988

12. START FREDAG 16:00 BANE 2 - GENNEM BØGESTRØMMEN

215 SØMIL

LØB 101 VEGA (STANDARD)

NR.	BÅDNAVN	TYPE	SEJLNR	BÅDENS FØRER	MÅL	ODDEN	AGERSØ	KALVEH	SALTH.	HELSINGØR	SEJLTID	POINTTID	PLAC
1631	DUKE	VEGA	D 956	NIELS BØRGLUM HANSEN	5.50	L08:50	L21:00	S03:50	S17:30	M00:12:59	56:12:59	63:43:26	PR 1
1632	HENKEN III	VEGA	D 994	FREDERIK MØLLER	5.50	L08:40	L21:08	S04:00	S18:25	M01:13:11	57:13:11	64:43:38	PR 2
1633	KRISTIANE II	VEGA	D 2018	KRISTIAN HJULSAGER	5.50	L09:25		S04:05	S20:05	M03:40:10	59:40:10	67:10:37	PR 3
1640	BICADO	VEGA	D 3135	K. ALBERG	5.50	L09:45		S05:35	S20:10	M04:08:05	60:08:05	67:38:32	4
1637	ANTI	VEGA	D 2493	ERLING CHRISTIANSEN	5.50	L09:50				M04:15:53	60:15:53	67:46:20	5
1636	FRU VOM	VEGA	D 2286	VILLY JENSEN	5.50	L09:05		S04:20	S19:55	M02:45:02	58:45:02	68:15:29+2	6
1630	SØRINE	VEGA	D 910	KENTH BRUUN	5.50	L09:10		S04:50	S20:45	M04:50:38	60:50:38	68:21:05	7
1629	INGEBORG	VEGA	D 849	PER SØGAARD NIELSEN	5.50	L09:35		S04:00		M03:34:20	59:34:20	69:04:47+2	8
1634	INDIAN SUMMER	VEGA	D 2079	HANS JØRGEN HANSEN	5.50	L10:55		S09:45		M07:26:18	63:26:18	70:56:45	9
1628	PETRINE	VEGA	D 168	FINN OLSEN	5.50	L11:25		S09:25	S23:55	M07:32:34	63:32:34	71:03:01	10
1638	RITTA	VEGA	D 2564	OLE E. ELSANG	5.50	L09:45		S09:55	M00:55	M08:42:26	64:42:26	72:12:53	11
1635	ULLA-BRITT	VEGA	D 2139	FLEMMING SYLVEST	5.50	L09:20		S04:15		UDGÅET			
1639	RIKKE	VEGA	D 2826	JAN GRUBERT	5.50	L09:50			S23:25	DISKVALIFICERET			

LØB 102 BIANCA 27

NR.	BÅDNAVN	TYPE	SEJLNR	BÅDENS FØRER	MÅL	ODDEN	AGERSØ	KALVEH	SALTH.	HELSINGØR	SEJLTID	POINTTID	PLAC
1648	BAS	BIA.27	D 490	JAN WENZELL	5.05	L11:15	S00:15	S09:45	S23:45	M06:30:01	62:30:01	68:26:33	PR 1
1641	FIE	BIA.27	D 271	PETER FRIIS	4.70	L11:45	S01:11	S12:21	M02:45	M10:28:04	66:28:04	71:02:48	PR 2
1645	SØMULE	BIA.27	D 428	KAARE THORSTEINSSON	4.75	L11:25	S01:15	S12:21	M03:40	M10:40:54	66:40:54	71:27:51	3
1642	SAFARI	BIA.27	D 406	HENRIK LANDSBERGER	5.00	L12:25	S03:04	S12:21	M03:30	M10:57:55	66:57:55	72:43:16	4
1646	BARBARA	BIA.27	D 467	K.ASBJØRN SMITT	5.05	L14:20	L23:15	S12:21		M11:33:38	67:33:38	73:30:10	5
1644	GIMLE	BIA.27	D 415	K.V. QVISTGAARD	4.70	L13:35		S13:03		M18:27:59	74:27:59	79:02:43	6
1643	SIESTA	BIA.27	D 413	JAN LEHNERT	4.70					UDGÅET			
1647	FJUMSE	BIA.27	D 470	NILS-ERIK BERG	5.05	L11:55	S01:50	S10:55	S10:55	UDGÅET			

LØB 103 DH 4.60 - 5.85 (MOTORSEJLERE)

NR.	BÅDNAVN	TYPE	SEJLNR	BÅDENS FØRER	MÅL	ODDEN	AGERSØ	KALVEH	SALTH.	HELSINGØR	SEJLTID	POINTTID	PLAC
1655	HANNE	H.R.29	D 295	JOHN BIRKBO	5.45			S03:55		S22:52:42	54:52:42	62:13:16	PR 1
1658	DIONA	LM.32	D 16	PEITER OLSEN	5.85	L07:55	L20:55	S03:25	S16:45	S22:46:37	54:46:37	63:22:47	PR 2
1653	HAGBARD	H.R.29	D 105	POUL FOGH	5.50	L09:20	L21:00	S04:05		M01:23:59	57:23:59	64:54:26	PR 3
1656	LOTUS	H.R.29	D 359	PETER HJELM-HANSEN	5.45			S04:55		M01:51:04	57:51:04	65:11:38	4
1651	PUMZIKA	H.R.29	D 55	POUL BENDIXEN	5.45	L09:45		S04:55	S19:55	M01:51:45	57:51:45	65:12:19	5
1654	BENTE	H.R.29	D 204	IB PETERSEN	5.45	L08:40		S05:20		M03:44:58	59:44:58	67:05:32	6
1652	KIKIJEJA	H.R.29	D 91	PALLE ORRY/KURT RASMUSSEN	5.45	L07:55		S04:05		M02:09:48	58:09:48	67:30:22+2	7
1657	LA VIE	JOJET 9	D 28	OLE C MØRCH	5.80			S04:50	S19:35	M03:54:11	59:54:11	68:21:19	8
1661	HABI	MER.315	D 20	HANS EGEDE	5.55	L11:45	S00:50	S10:55	M01:30	M09:18:52	65:18:52	72:59:04	9
1662	NN	MØN 291	D 1	HANS GABELGAARD	5.35	L11:25	L23:50	S05:25		M10:00:21	66:00:21	73:00:46	10
1649	NAUTA	BIA.QUE	D 16	HENNING KJER	4.60		L17:30			UDGÅET			
1659	FLEURIE	MER.290	D 197	POUL BERNT JENSEN	5.75					IKKE STARTET			
1660	SOFFI	MER.290	D 296	POUL LYKKEMARK	5.55					IKKE STARTET			

RESULTATLISTE SJÆLLAND RUNDT 1988

12. START FREDAG 16:00 BANE 2 - GENNEM BØGESTRØMMEN

215 SØMIL

LØB 104 DH 4.65 - 7.05

NR.	BÅDNAVN	TYPE	SEJLNR	BÅDENS FØRER	MÅL	ODDEN	AGERSØ	KALVEH	SALTH.	HELSINGØR	SEJLTID	POINTTID	PLAC
1687	FRU MADSEN	N.SNEK	D 51	OLE SCHMIDT	5.35	L06:13	L16:35	L21:50		S12:28:45	44:28:45	51:29:10	PR 1
1685	MAGGAN	MAXI80	S 251	BENGT CARAEUS	6.30	L05:56	L16:05	L21:15		S10:40:04	42:40:04	52:32:51	PR 2
1703	THETTIS	VIND40	S 570	MAGNUS WENDT	5.75		L20:59		S17:20	S22:57:04	54:57:04	63:15:02	PR 3
1677	SINDIG	JAG.27	D 688	LOUIS RASMUSSEN	4.90	L09:45		S05:20	S19:50	M02:08:50	58:08:50	63:31:20	PR 4
1689	HELA RATARE	NIMB26	D 19	TORBEN BRØGGER	5.60			S03:55		M00:05:06	56:05:06	63:54:56	PR 5
1777	CAPPRICCIO	WAMP.24	D 8	F. WENZEL WEGLER	5.85	L09:35	L20:55	S04:05		S23:28:23	55:28:23	64:04:33	PR 6
1700	SPAR TO	VEGA	D 945	JØRGEN JENSEN	5.40		L21:12	S04:10	S19:25	M01:37:13	57:37:13	64:47:47	PR 7
1666	BUNNY	BAND26	D 78	NIELS POULSEN	5.05			S04:40		M02:56:42	58:56:42	64:53:14	PR 8
1694	JEKI	OE 30	D 30	MICHAEL SINDING-JENSEN	5.40	L08:40		S04:40	S19:20	M01:48:44	57:48:44	64:59:18	9
1698	LASSE	VEGA	V 748	CHR. GULDHAMMER NIELSEN	5.50	L08:45		S04:55	S19:50	M02:46:21	58:46:21	66:16:48	10
1705	VIVA	VINDØ32	D 298	OLE SKOU	5.85	L09:35		S05:35		M02:04:34	58:04:34	66:40:44	11
1688	RATARE	NIMB26	D 6	OLE HEGELUND	5.60	L09:05		S05:00	S20:05	M02:51:47	58:51:47	66:41:37	12
1699	NUSER	VEGA	D 803	PER OLSEN	5.50	L09:40		S05:30		M03:18:25	59:18:25	66:48:52	13
1697	DIDA IV	STR.KRY	D 4	PER OLSEN	4.90	L09:35	L21:05	S04:45		M03:29:29	59:29:29	66:51:59+2	14
1676	ARKEN	JAG.27	D 204	STIG WESSBERG	5.55	L09:40		S04:05		M03:31:06	59:31:06	67:11:18	15
1701	GURLI MARGRETE	VEGA	D 2845	INGRID KRISTENSEN	5.40			S05:40		M04:20:54	60:20:54	67:31:28	16
1680	FAJO	K.CR29	D 3	PALLE JOENSEN	5.75	L09:05			M01:30	M03:35:12	59:35:12	67:53:10	17
1686	KRAKA	N.SNEK	D 36	LASSE JOES NIELSEN	5.65	L07:43			S19:25	M02:27:57	58:27:57	68:27:17+2	18
1665	IBIS	BACC.IV	D 30	BJØRN LUNDBY ANDERSEN	7.05	L09:45	L21:07	S04:55	S19:35	M01:22:30	57:22:30	69:06:56	19
1671	EVA MERETE	G.D.28	D 5	PAUL HANSEN	4.95	L13:15		S12:21	M02:15	M10:02:36	66:02:36	71:36:36	20
1675	C'EST LA VIE	HEL. 33	D 2	SØREN ALBERTSEN	5.70	L10:55		S09:25	M00:35	M07:32:58	63:32:58	71:41:41	21
1672	KHENSU	G.D.28	D 88	FLEMMING MØRCH SØRENSEN	4.65	L12:20	S03:01		M02:10	M11:33:36	67:33:36	71:55:53	22
1702	ROSINANTE II	VEGA	D 3050	JETTE GREISVOLD	5.15	L12:30	S03:22	S12:59	M02:15	M10:11:33	66:11:33	72:29:59	23
1674	CORSAREN	GRAC30	D 24	JESS RINGVIG	5.25	L12:10	S01:35	S11:20		M09:52:55	65:52:55	72:32:38	24
1696	GANDALF	SLOOP	D 49	PETER LAURIDSEN	5.25	L08:45	S03:33	S12:21	M02:15	M10:19:04	66:19:04	72:58:47	25
1693	SANNE	NIMB26	D 67	JENS P JENSEN	5.50	L11:20		S10:30		M09:54:19	65:54:19	73:24:46	26
1673	ELIZA	GRAC30	D 2	CHARLY LETH	5.60	L08:40	S00:03	S10:30		M09:56:08	65:56:08	73:45:58	27
1704	SIRIUS	VIND50	D 89	MIKAEL JUUL ERTHMANN	5.75	L13:35	S02:50	S12:21		M09:55:54	65:55:54	74:13:52	28
1692	SMARAGD	NIMB26	D 64	DAN BARFRED	5.25	L11:30	S00:02	S12:10		M11:57:08	67:57:08	74:36:51	29
1690	SNÅLLE VIKING	NIMB26	D 30	MICHAEL BORREMOSE	5.70	L11:10	S00:35	S11:10	M02:10	M10:40:09	66:40:09	74:48:52	30
1681	CHARLOTTE	K.CR29	D 199	ERIC BRYDE	5.85		S03:12	S12:10		M10:42:33	66:42:33	75:18:43	31
1668	PIA	CONTE29	D 8	OTTO ELLERMANN JENSEN	5.75	L11:55	S06:15	S13:44	M04:00	M12:25:53	68:25:53	76:43:51	32
1670	OPIUM	G.D.28		HENRI A. SINDT	5.00	L11:50				UDGÅET			
1679	BERTRA	JENSEN.	D 57	BENT GRAHN	5.65	L12:30				UDGÅET			
1682	GRØN	K.CR29	D 227	P-H APPELQVIST	5.90	L08:40		S04:45		UDGÅET			
1683	HEIDI	KUTTER	D 69	JENS BUCH	6.20	L13:00				UDGÅET			
1691	KAREN MARIE	NIMB26	D 62	POUL LINNET	5.35	L11:35	S01:35			UDGÅET			
1669	TEQUILA	FINGAL	S 1570	GÖRAN PERSSON	5.20	L08:01		S04:05	S19:40	DISKVALIFICERET			
1678	DOLLY II	JENSEN.	D 53	TOMMY LARSEN	5.35					IKKE STARTET			
1684	FREEDOM	KUTTER	D 210	JOHNNI OLSEN	5.30					IKKE STARTET			

LØB 105 DH 4.30 - 5.00 (MOTORSEJLERE)

NR.	BÅDNAVN	TYPE	SEJLNR	BÅDENS FØRER	MÅL	ODDEN	AGERSØ	KALVEH	SALTH.	HELSINGØR	SEJLTID	POINTTID	PLAC
1710	LADY	LM.26	D 48	POUL QUISTGÅRD	4.90	L09:00		S03:55		M00:38:07	56:38:07	62:00:37	PR 1
1712	KNIRKE	LM.26	D 79	CLAUS LYTHJE	4.85	L09:45		S04:10		M02:34:28	58:34:28	63:45:17	PR 2
1711	PRIK	LM.26	D 60	FOLMER MADSEN	4.90	L09:55		S04:40		M02:32:53	58:32:53	63:55:23	PR 3
1706	AKVA IV	LM 28	D 92	KNUD B. MIKKELSEN	5.00	L09:45		S06:40		M05:24:26	61:24:26	67:09:47	4
1709	CIRKELINE	LM 81	D 44	FINN TANGAA	4.40	L11:45	S01:00	S12:21	M02:15	M10:03:06	66:03:06	69:20:23	5
1717	GRAFEN	MEDUSA	D 89	JENS H DALGÅRD	4.30	L16:18	S08:30	S15:52	M04:45	M14:02:38	70:02:38	72:52:22	6
1716	PALLAS	MEDUSA	D 82	PALLE KJÆR	4.30	L15:55	S08:15	S15:54		M14:47:31	70:47:31	73:37:15	7
1718	ATHENA	MEDUSA	D 93	PREBEN SKAT NIELSEN	4.50		S12:20	S20:35		M20:53:03	76:53:03	80:36:58	8
1707	THALLATTA	LM 28	D 135	FLEMMING HANSEN	4.70	L12:10	S00:15	S12:21		UDGÅET			
1708	HEBE	LM 28	D 237	KNUD ERIK JØRGENSEN	4.90					UDGÅET			
1713	BETICA	LM.27	D36666	CARSTEN HØY	4.50					UDGÅET			
1714	KNIRKE 2	LM.27	D 209	GERT NIELSEN	4.35					UDGÅET			
1715	NAJA	MASC.28	D 58	NILS JØRGENSEN	4.70	L15:30				UDGÅET			

LØB 106 NORDSHIP 28

NR.	BÅDNAVN	TYPE	SEJLNR	BÅDENS FØRER	MÅL	ODDEN	AGERSØ	KALVEH	SALTH.	HELSINGØR	SEJLTID	POINTTID	PLAC
1664	GAIA	NORS.28	D 140	KURT HANSEN	5.20	L08:55	S03:45	S05:25	S19:35	M02:54:45	58:54:45	65:23:53	PR 1
1721	NUMI	NORS.28	D 65	BØRGE WESTERGAARD	5.85	L07:18	L20:59	S04:05		M00:57:33	56:57:33	65:33:43	PR 2
1724	ANDERSTINA	NORS.28	D 143	JAN ANDERSEN	5.30	L09:55		S04:50	S20:25	M03:17:05	59:17:05	66:07:13	3
1722	BOB II	NORS.28	D 75	ERIK BOLDRUP	5.85	L09:00		S04:35	S19:35	M01:32:28	57:32:28	66:08:38	4
1719		NORS.28	D 24	KARIN NIELSEN-TJØR	5.85	L09:40		S06:50	S20:00	M04:31:09	60:31:09	69:07:19	5
1663	APHRODITE	NORS.28	D 132	IB BACH ANDERSEN	5.85	L08:50				UDGÅET			
1723	SØKAT	NORS.28	D 115	SØREN B. CARL	5.25	L12:45		S12:10		UDGÅET			
1720	NORDSTAR	NORS.28	D 60	KIM LINDINGER	5.80					IKKE STARTET			

RESULTATLISTE SJÆLLAND RUNDT 1988

12. START FREDAG 16:00 BANE 2 - GENNEM BØGESTRØMMEN

215 SØMIL

LØB 107 DH 3.75 - 5.55

NR.	BÅDNAVN	TYPE	SEJLNR	BÅDENS FØRER	MÅL	ODDEN	AGERSØ	KALVEH	SALTH.	HELSEINGØR	SEJLTID	POINTTID	PLAC
1741	JOY	W.GK 24	D 87	OLE NEERGAARD	5.55	L08:40		S05:20	S19:20	M01:37:44	57:37:44	65:17:56	PR 1
1727	ROSITA	ALB.VIG	D 1164	HAMMAR + STEEN	5.20	L09:50		S05:25	S19:50	M03:46:29	59:46:29	66:15:37	PR 2
1726	MIDDE	ALB.VIG	D 883	CARL ERIK HANSEN	5.35	L09:15		S04:50		M03:09:32	59:09:32	68:09:57+2	PR 3
1729	NEFERTETE	AMIG23	D 269	KNUD ERIK LINTRUP	3.75	L15:30	S05:50	S14:18		M12:42:58	68:42:58	68:42:58	PR 4
1735	DAN	KUTTER	D 324	OLE NÆSTED	4.25	L11:50	S01:47	S11:00	M03:30	M10:41:09	66:41:09	69:16:48	5
1728	WOODSTOCK	AMIG23	D 109	C. SOMMER	4.00		S05:45	S14:04	M03:40	M12:13:50	68:13:50	69:35:10	6
1739	SUNDOWNER	SUNB.22	D 501	BENT MICHAEL NIELSEN	5.20	L09:35	L22:40	S09:40	S23:45	M07:18:26	63:18:26	69:47:34	7
1737	RIKKE RASK	PRI.28	D 13	OLE RASK	5.30	L11:35	L21:09	S10:55	M00:20	M07:49:38	63:49:38	70:39:46	8
1743	BONUS 2	WESTTI	D 61	MICHAEL WILKEN	4.90	L11:05	L23:15	S10:30	M01:15	M09:18:44	65:18:44	70:41:14	9
1736	PYLL	MAXI68	D 1042	OSKAR SJØLAND	4.85	L14:00	S03:51	S12:45	M03:40	M11:57:36	67:57:36	73:08:25	10
1740	TROLDEN	TRISS	D 77	BENT VOLLMER	4.55		S05:45	S14:05	M03:30	M13:23:13	69:23:13	73:20:08	11
1742	TOVE	WESTCI	D 234	KNUD ANDERSEN	4.05		S09:05	S16:45	M05:05	M17:03:31	73:03:31	74:40:13	12
1725	OLINE	ALB.VIG	D 588	ASGER BENGTSEN	5.35	L12:30	S03:47	S12:21		M12:14:07	68:14:07	75:14:32	13
1731	SKOTTE	HURL22	D 269	BJØRN PAULSEN	4.55	L13:35	S04:00	S12:43	M03:30	UDGÅET			
1733	SUPER HILDA	JUNK22	D 349	TONNY KNUDSEN	4.05	L16:08				UDGÅET			
1734	CONCORDIA	KUTTER	D 4	JØRGEN TELL	4.30	L15:50				UDGÅET			
1738	HEPP	PRI.28	D 36	NIELS PESCHARDT	5.20	L11:35				UDGÅET			
1732	MR. BAD GUY	JAG.22	D 664	PETER CORFITSEN	4.85					IKKE STARTET			

LØB 108 GAFFELRIGGERE

NR.	BÅDNAVN	TYPE	SEJLNR	BÅDENS FØRER	MÅL	ODDEN	AGERSØ	KALVEH	SALTH.	HELSEINGØR	SEJLTID	POINTTID	PLAC
1745	FREM I	GAFFEL	D 1	JØRN HENRIKSEN	4.90	L12:00	S00:44	S11:00	M00:30	M07:12:50	63:12:50	68:35:20	PR 1
1747	ANAKONDA	GAFFEL	R 2	ARNE KEMP	4.60	L12:45	S01:47	S11:05	M01:40	M08:50:02	64:50:02	68:59:45	PR 2
1750	FREM III	GAFFEL	D 3	KRISTEN RIIS JENSEN	4.75	L14:15	S03:13	S12:10	M01:35	M08:51:58	64:51:58	69:38:55	PR 3
1753	NORDVEST	GAFFEL	D 6	KLAUS B. ANDERSEN	4.75	L14:00	S03:20	S12:11		M09:23:30	65:23:30	70:10:27	4
1752	SUNDET	GAFFEL	D 5	LEIF PETERSEN	4.75	L12:50	S02:45	S11:20		M10:56:53	66:56:53	71:43:50	5
1667	DAGMAR	COAR	S 1	ARNE AULIN	5.00					UDGÅET			
1751	SIGYN	GAFFEL	D 4	ERIK CAPTYN	5.30	L12:25	S01:47	S10:50	M00:20	DISKVALIFICERET			
1746	FREYA	GAFFEL	D 1	TORSTEN RIISMARK	5.30	L12:50		S12:11	M01:00	DISKVALIFICERET			
1748	YDUN	GAFFEL	D 2	EYVIND DE THURAH	5.30		S03:10	S12:10	M01:00	DISKVALIFICERET			
1744	FUR I	GAFFEL		SØREN FREDERIKSEN	5.30	L11:35		S11:05	M01:40	DISKVALIFICERET			
1749	FYLLA	GAFFEL	D 3	LARS MICHLER	5.30	L13:35	S02:02	S11:00	M01:15	DISKVALIFICERET			

LØB 109 LA.KRYDSERE (STANDARD)

NR.	BÅDNAVN	TYPE	SEJLNR	BÅDENS FØRER	MÅL	ODDEN	AGERSØ	KALVEH	SALTH.	HELSEINGØR	SEJLTID	POINTTID	PLAC
1763	JOKER	LA.KR.	D 173	JENS MUNCH-HANSEN	5.90			S04:50	S19:20	M01:24:35	57:24:35	66:09:41	PR 1
1756	SEXTANTEN	LA.KR.	D 101	PER SØDERHAMN	5.90	L09:35		S09:25	M00:20	M07:45:42	63:45:42	72:30:48	PR 2
1757	EVA	LA.KR.	D 116	KNUD ZIEGLER	5.90	L09:45				M08:16:04	64:16:04	73:01:10	PR 3
1761	KNIRKE	LA.KR.	D 152	F. GRENAE	5.90	L11:25	S08:15	S16:22		M12:58:36	68:58:36	77:43:42	4
1759	MONA	LA.KR.	D 132	FRANK BORDAL	5.90	L13:35	S03:35	S14:33		M14:09:10	70:09:10	78:54:16	5
1754	OLGA	LA.KR.	D 69	LEIF SKOV	5.90	L09:45		S05:25		UDGÅET			
1755	LA-VEJR	LA.KR.	D 98	PER THORDAL	5.90					UDGÅET			
1760	LASS	LA.KR.	D 140	STEEN ANDERSEN	5.90					UDGÅET			
1758	JAKAJO	LA.KR.	D 131	JOHN GERICKE	5.90					IKKE STARTET			
1762	ZEB	LA.KR.	D 158	HANNE KURE LARSEN	5.90					IKKE STARTET			
1764	ANANCY	LA.KR.	D 180	JØRGEN ILUM NIELSEN	5.90					IKKE STARTET			

LØB 110 SPIDSGATTERE

NR.	BÅDNAVN	TYPE	SEJLNR	BÅDENS FØRER	MÅL	ODDEN	AGERSØ	KALVEH	SALTH.	HELSEINGØR	SEJLTID	POINTTID	PLAC
1772	TROLDROSEN	SPGAT.	D 143	UFFE SKADEGAARD	6.10	L07:48		S04:45	S17:45	S23:49:22	55:49:22	65:09:07	PR 1
1771	SILENCE	SPGAT.	D 141	VIGGO DANDANELL	6.25	L08:45		S04:50	S19:35	M01:30:02	57:30:02	67:14:43	PR 2
1770	VINJE	SPGAT.	D 39	ERIK R. HANSEN	5.90		L21:07	S04:40	S20:00	M03:48:07	59:48:07	68:33:13	3
1765	GERTY VI	BÆLT.25	M 3	HENNING ANDERSEN	5.30	L09:45		S09:10	S23:45	M06:31:00	62:31:00	69:21:08	4
1768	DELFIN	SPGAT.	D 2	TOM JENS HANSEN	5.00			S12:21	M01:00	M09:06:25	65:06:25	70:51:46	5
1769	AIDA	SPGAT.	D 38	SVEN HANSEN	5.10	L13:05	S03:37	S12:21	M02:15	M10:38:39	66:38:39	72:46:11	6
1766	SUKI	SPGAT.		JØRN HAMMER LARSEN	7.00					IKKE STARTET			
1767	BLOMSTEN II	SPGAT.	D 1	LASSE NIELS LASSEN	4.30					IKKE STARTET			

Stå til søs med Bådlån i Bikuben



Drømmer du om at stå til søs i en ny båd, eller tænker du på at udskifte den, du har? Så lad Bikuben gøre det let for dig med et Bådlån.

Bådlån i Bikuben er et lavt forrentet lån, som vi tilpasser dit budget og som tilbagebetales på op til 15 år, alt efter ønske og behov.

Sammen med et Bådlån i Bikuben kan du få en Udstyrs-Kredit til alt det, der som regel kommer til, når du har købt båd. F.eks. VHF, ekkolod, køleskab m.v.

– Kort sagt, alt det, der gør det sjovere og sikrere at sejle.

Lad os tale om mulighederne, så du kan blive godt sejlende – også økonomisk.



 **Bikuben**

Den gik rent ind...

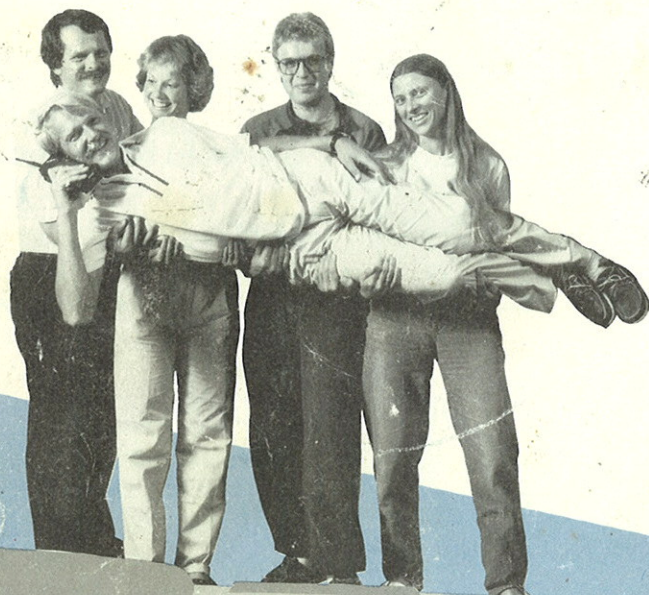

Tak til alle der holdt den rene linie, og var med til at bevare miljøet rundt om Sjælland.

Og tillykke til skipper og besætning på HUPS II, som var de heldige vindere af den bærbare Nokia-Mobira telefon, model "City Man" - linien der går rent ind. .

På gensyn i 1989

NOKIA DATA

Hovedsponsor for
Sjælland Rundt 1988