

ROD 70

PALO PROTEZIONE
BOLLARD

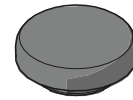

RESISTANT TO
LOW TEMPERATURES

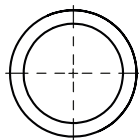
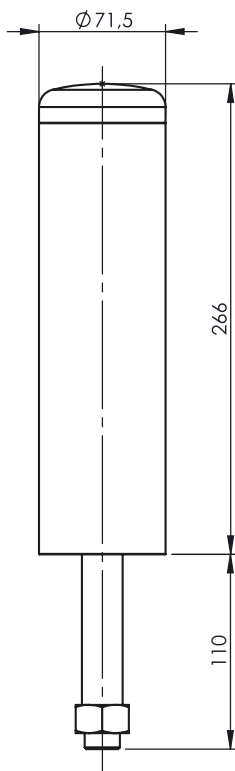

PCC 70



NUT M20



SPRING WASHER M 20



WASHER M20

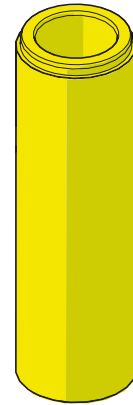

PC 70 266



THREADED ROD M20

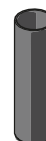

PVC TUBE



NUT M20

ROD 70

ISTRUZIONI DI INSTALLAZIONE
ASSEMBLY INSTRUCTIONS



RESISTANT TO
LOW TEMPERATURES

CHEMICAL
ANCHOR

Ø38 mm

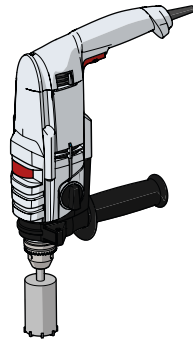

46

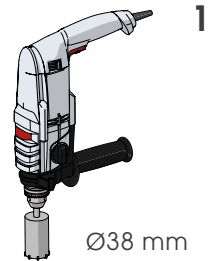
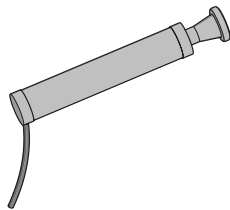

Ø38 mm

115 mm

2

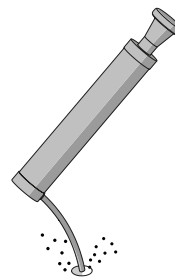

3

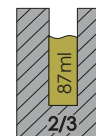
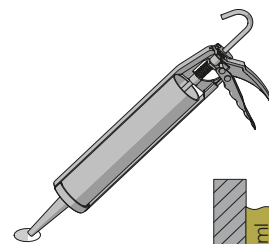

4

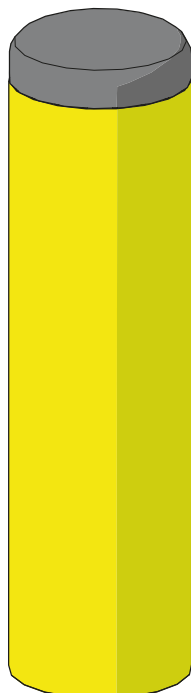
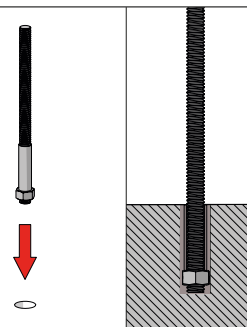

ROD 70

ISTRUZIONI DI INSTALLAZIONE
ASSEMBLY INSTRUCTIONS



RESISTANT TO
LOW TEMPERATURES

ROD REPLACEMENT

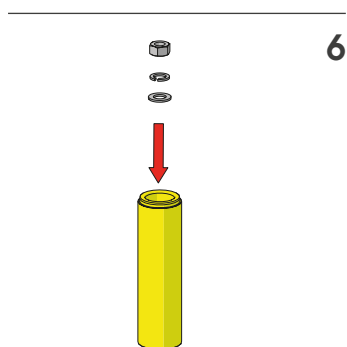
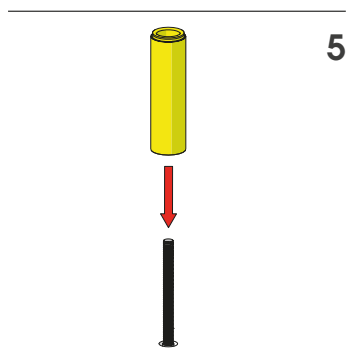

T=120Nm

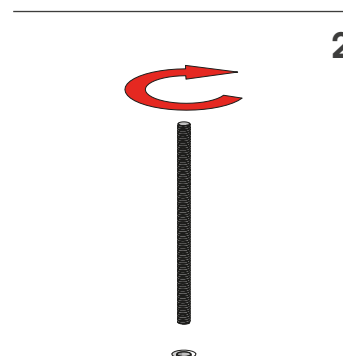
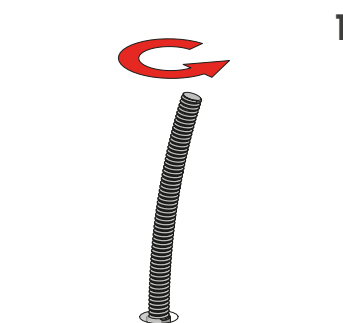
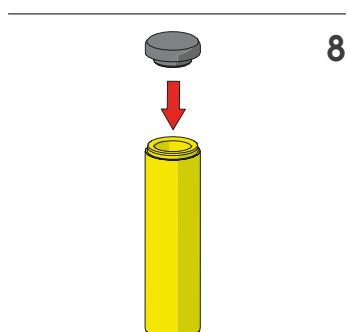
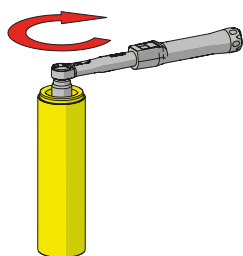

ROD 120

PALO PROTEZIONE
BOLLARD



RESISTANT TO
LOW TEMPERATURES

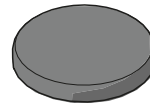
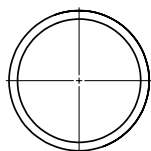
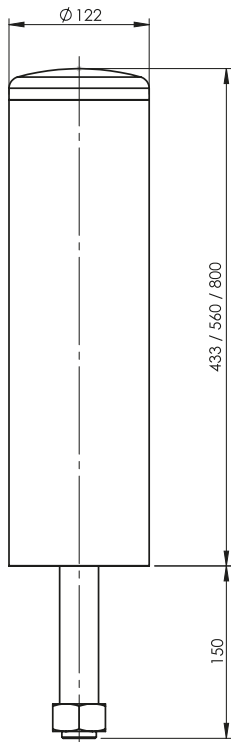

PCC 120



NUT M30



SPRING WASHER M30



WASHER M30

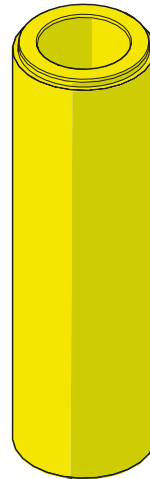

PC 120 433 / 560 / 800



THREADED ROD M30



PVC TUBE



NUT M30

ROD 120

ISTRUZIONI DI INSTALLAZIONE
ASSEMBLY INSTRUCTIONS



RESISTANT TO
LOW TEMPERATURES

CHEMICAL
ANCHOR

Ø56 mm

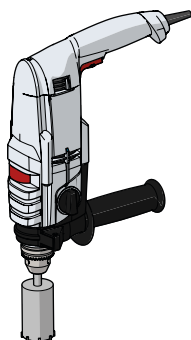
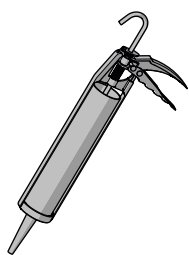

46

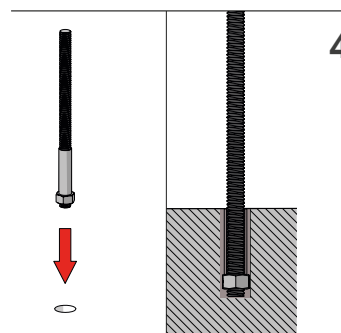
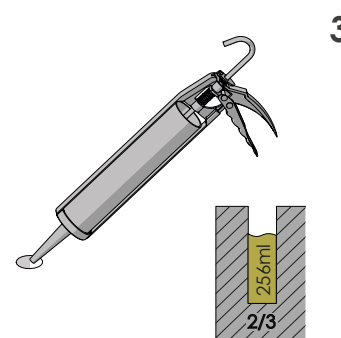
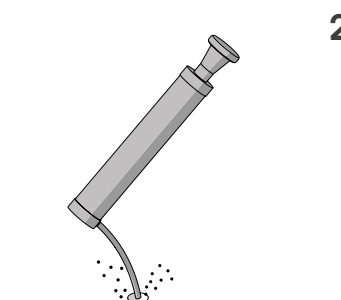
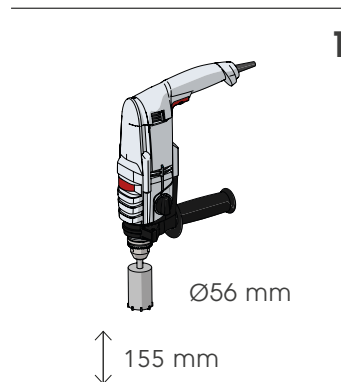
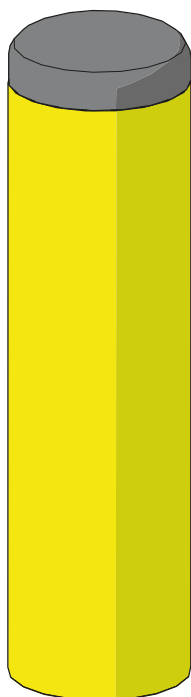
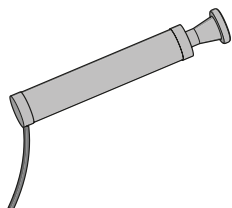

ROD 120

ISTRUZIONI DI INSTALLAZIONE
ASSEMBLY INSTRUCTIONS



RESISTANT TO
LOW TEMPERATURES

ROD REPLACEMENT

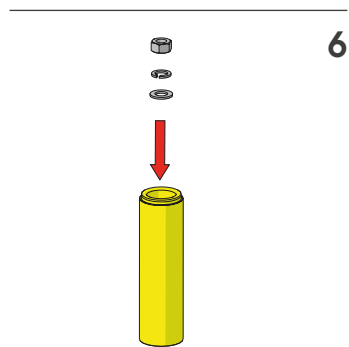
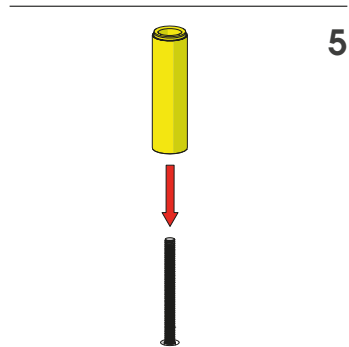

T=200Nm

7

