

**AB Ramantenn**



# LT-4100 SATELLITE COMMUNICATIONS SYSTEM

## IRIDIUM CERTUS® 100

designed and built for the demanding and rough environment at sea

## LT-4100 IN SHORT

- 2 x Voice Channels (high quality)
- IP-data: 22 kbps (up) / 88 kbps (down)
- Single antenna cable solution (up to 500 m)
- Handset included in the box
- Support for external SIP PABX and SIP handsets (up to 8)
- POTS through Analogue Telephone Adaptors (ATA)
- Bluetooth interface for data access (PAN-profile)
- High-performance GNSS/GPS receiver
- Ethernet LAN interface on control unit
- Large 4.3" TFT display supporting day and night modes
- Voice prompt audio feedback
- Firewall and user authentication for high level of security
- IP-data management (web access filtering, data limits, etc.)
- Web server for configuration and maintenance
- Prepared for Iridium Certus GMDSS

## PRODUCT DESCRIPTION

The LT-4100 Satellite Communications System (Iridium Certus 100) is a maritime satellite communication product from Lars Thrane A/S. The LT-4100 system is designed for the professional market (deep sea, fishing, and workboats), but can be used for the leisure market as well. The LT-4100 system meets all standards and certification requirements needed for worldwide maritime satellite communication equipment.

The LT-4100 system has voice and data capabilities with 100% global coverage provided by the Iridium Communications Network. The LT-4100 system consists of a control unit, antenna unit, handset, and cradle.

A single coaxial cable connects the control unit with the antenna unit. Using a standard coaxial cable, up to 500 meters of separation between the units can be obtained, giving freedom to mount the antenna unit in the best possible location, with free line of sight to the satellites.

The LT-4100 system can be used as the primary satellite communication product on vessels, covering the basic communication needs in terms of connectivity (ship to ship / ship to shore). The LT-4100 system offers 2 high quality voice channels, and IP-data 22 kbps (up) / 88 kbps (down), making it the perfect satellite communication product on board any vessel.

## PRODUCT FEATURES

### VOLUME CONTROL

Handset speaker volume control button

### RINGER

Incoming call ringer

### MICROPHONE

High-quality microphone

### COLOR DISPLAY

Large 4.3" TFT display supporting brightness adjustment and day/night mode themes

### KEYPAD

Responsive keypad with brightness adjustments

### AUDIO SPEAKER

Audio speaker supporting key beep, voice prompt, and alarms

### FUNCTIONAL KEYS

Functional keys; off-hook, on-hook, navigation, and soft keys

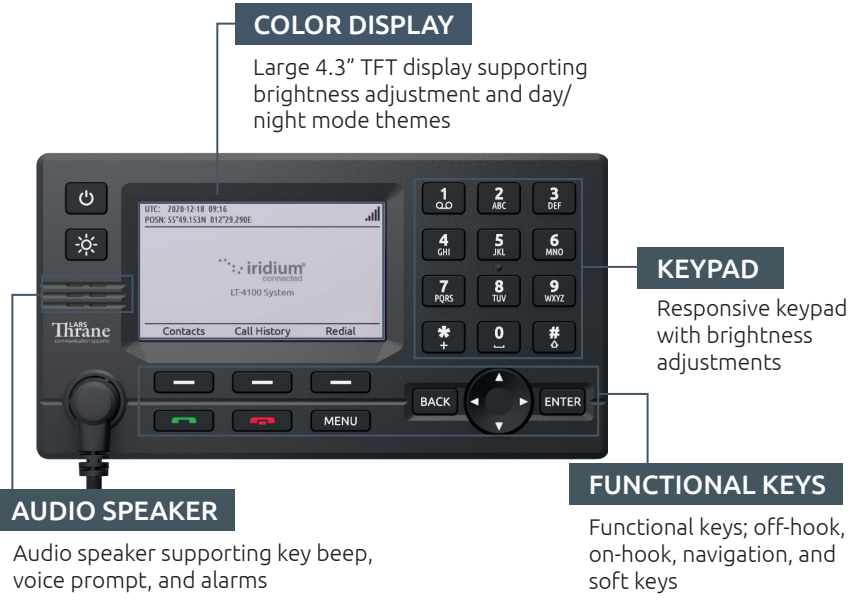

# INTERFACES

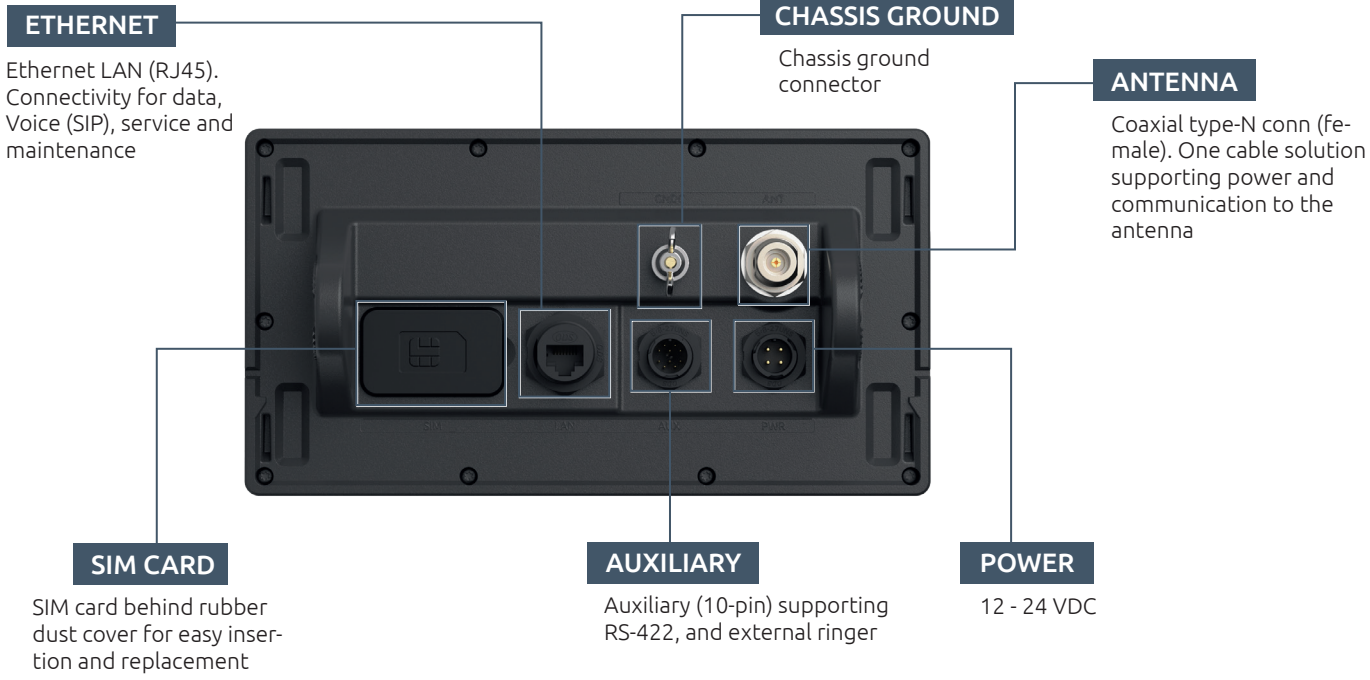

# INSTALLATION OPTIONS

## ANTENNA MOUNTING KITS



Pole Mount (2.0" pipe, Ø53.0mm), Antenna Unit



Bracket Mount (1.5" to 2.5" pipe), Antenna Unit

## CONTROL UNIT MOUNTING KITS



Bracket Mount, Control Unit

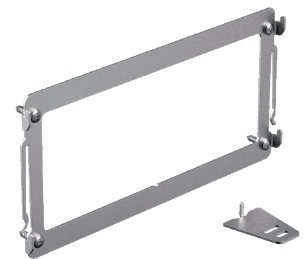

Flush Mount, Control Unit

# SYSTEM CONFIGURATION

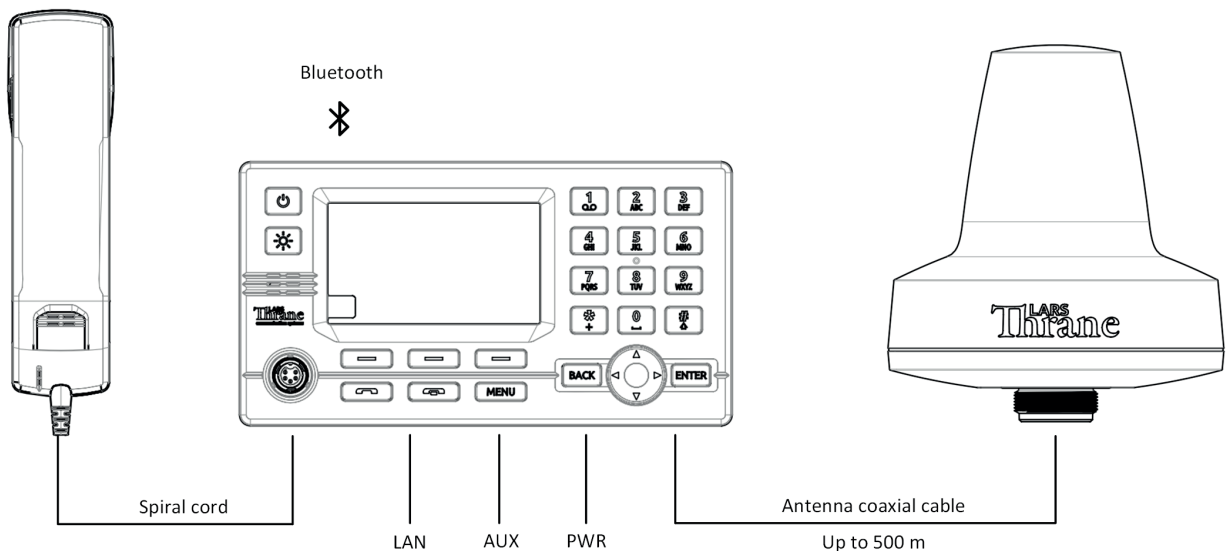

# SPECIFICATIONS

## LT-4100 SATELLITE COMMUNICATIONS SYSTEM

Certification & standards	RED, FCC, ISED, RoHS 2, Iridium®
Vibration, operational	IEC 60945
Vibration, shock	Half sine 20 g/11 ms
Compass Safe Distance, std.	1.0 m (3.3 ft)
Compass Safe Distance, steer.	0.9 m (3.0 ft)
Power consumption: operating mode, max	41 W
Power consumption: standby mode, max	21 W
Power consumption: sleep mode, max	0.1 W

## LT-3110 Control Unit

Weight	0.67 kg (1.48 lbs)
Dimensions	224.0 x 120.0 x 70.0 mm (8.82 x 4.72 x 2.76 in)
Temperature, operational	-15°C to +55°C (+5°F to +131°F)
IP rating, dust and water	IP32
Interfaces	Ethernet, auxiliary, DC input, chassis ground Antenna Unit (N conn.), handset, Bluetooth, SIM card
Input power	12-24 VDC (2.2-1.7 A)*

## LT-3120 Handset Unit

Weight (handset + wire)	0.30 kg (0.66 lbs)
Dimensions	52.8 x 208.8 x 38.2 mm (2.08 x 8.22 x 1.50 in)
Temperature, operational	-15°C to +55°C (+5°F to +131°F)
IP rating, dust and water	IP32

## LT-4130 Antenna Unit

Weight	1.39 kg (3.05 lbs)
Dimensions	182 x Ø 162 mm (7.16 x Ø 6.39 in)
Temperature, operational	-40°C to +55°C (-40°F to +131°F)
IP rating, dust and water	IP67
Interfaces	Control Unit (N conn.)
Antenna communication cable	Coaxial cable, up to 500 m (1500 ft)
Warranty	2 year
Maintenance	None

\* When 12 VDC input power is used, the maximum cable length will be reduced and thus less power.

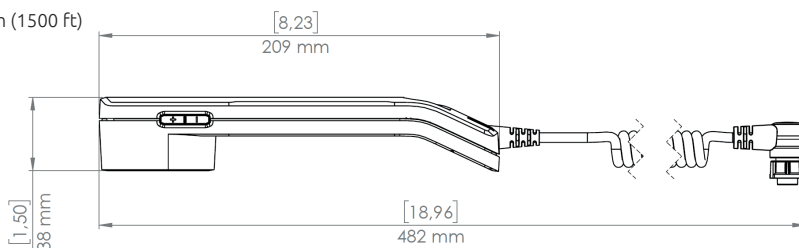
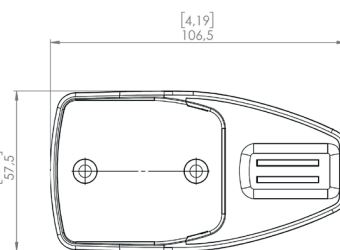
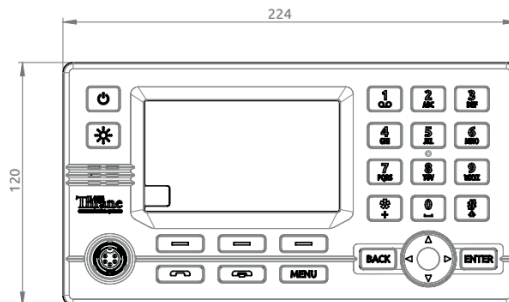
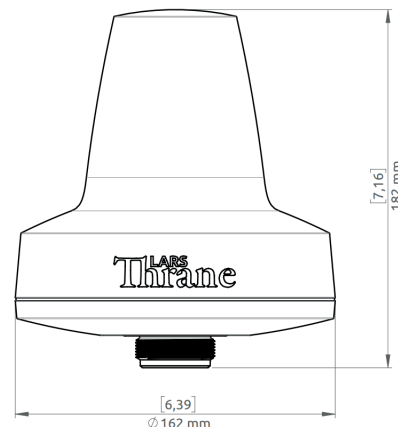

## IN THE BOX

LT-3110 Control Unit	P/N: 51-100987
LT-3120 Handset	P/N: 51-100988
LT-3121 Cradle	P/N: 51-101181
LT-4130 Antenna Unit	P/N: 51-102365
Bracket Mount, Control Unit	P/N: 91-100771
Power Cable, 3m	P/N: 91-102118
User & Installation Manual	P/N: 95-102576

## ACCESSORIES

Flush Mount, Control Unit	P/N: 91-100772
Bracket Mount (1.5" to 2.5" pipe), Antenna Unit	P/N: 91-102469
Pole Mount (1.5" pipe, Ø38.8mm), Antenna Unit	P/N: 91-100774
Pole Mount (2.0" pipe, Ø53.0mm), Antenna Unit	P/N: 91-102550
Auxiliary Cable, 3m	P/N: 91-100768
Coaxial Cable Ø4.9mm (up to 100m)	
Coaxial Cable Ø10.3mm (up to 500m)	



Lars Thrane A/S  
 Skovlytoften 33  
 DK-2840 Holte, Denmark  
 Phone: +45 88 30 10 00 Fax: +45 88 30 10 09  
 Email: sales@thrane.eu  
 CVR DK-36042443  
 www.thrane.eu