

Technical data sheet - TXD Telescopic Platform Double row depth system



Introduction

A double depth retractable seating system which allows optimum space utilisation where ceiling height is an issue. TXD is a durable, low maintenance system, refined enough for education, arts and conference facilities but tough enough for arenas. Designed for low maintenance and a long life, TXD delivers strong financial benefits to owners and operators.

Features

- Architectural levels of finish and refined detailing
- Available with a wide choice of chairs
- Dynamically correct stiff structure with built in automatic row locks
- Cushioned, row to row contact to minimise noise
- Power operated opening/closing system
- 10 year guarantee on structure



Robust spring and gravity operated row locking system to lock opened rows securely in place, even in seismic areas.

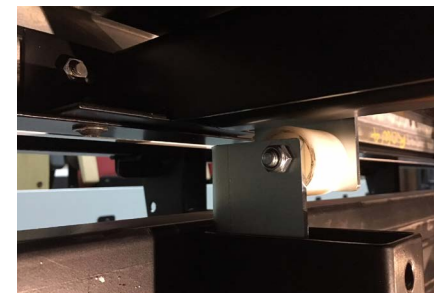

Designed to eliminate metal-to-metal contact to reduce wear, warping and noise.



Bolted construction is continuously adjustable throughout system life to keep system running smoothly and reduce risk of wear or jamming.



Diagonal bracing members manufactured from strong steel channel with secondary bracing for very large systems.

Storage Options

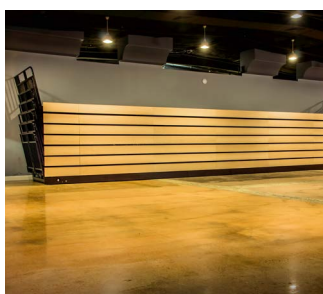

Type F - Floor and wall fixed. Stays in place once closed.

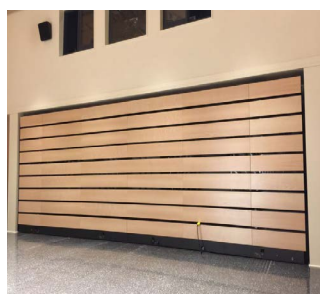

Type R - Recessed unit - slides back into a recess, or under a balcony once closed.



Type M - Mobile. Once closed, units can be specified to be moved via fork lift truck.



Type V - Travelling unit which allows movement as a complete bank, forwards and backwards, from its stored position.

Dimensions

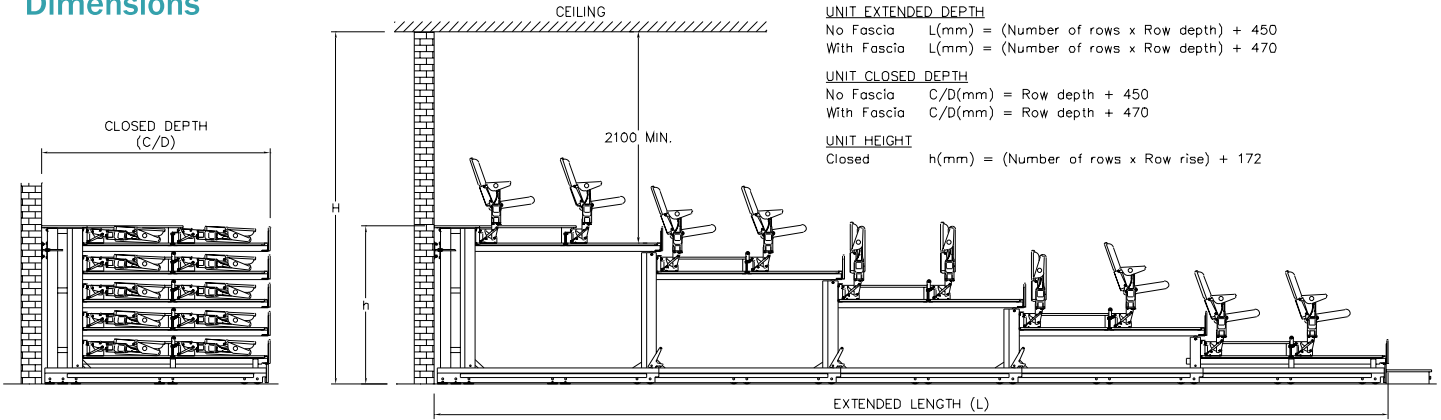

Platform depths

1700, 1800, 1900mm. Other depths available in special circumstances. For row depths compatible with each chair type, please refer to the table on the right.

Platform rises

280, 300, 320, 340mm. Other platform rises available in special circumstances.

Number of rows

If more than five platforms (ten rows of seats) are required, please consult Audience Systems.

	Platform depth (mm)		
	1700	1800	1900
Espace 628 / standard geometry	✓	✓	✓
Espace 628 / upright geometry	✗	✓	✓
Espace 628T	✓	✓	✓
Espace 628 High Back / CC	Check with Audience Systems		
Recital	Check with Audience Systems		
Accolade	✗	✓	✓
Zenith	✓	✓	✓
Alpha	✗	✓	✓

Platform Opening and Closing Options



Manual operation via removable pull handles (units up to 6m wide with up to three platforms only).



Power operation - Pendant control operating friction power drive. See separate datasheet for full specification.



Power truck operation.

Special Configurations



Partial Opening System - A mechanical locking system allowing the platforms to be safely opened to a specified number of rows, starting at the front.



Truncation - Allows the platforms to be safely opened to a specified number of rows, starting at the back. Posts are provided to safely support the open platforms.



Permanent Truncation - front row permanently raised to improve sightlines, or to allow for additional seating in front.

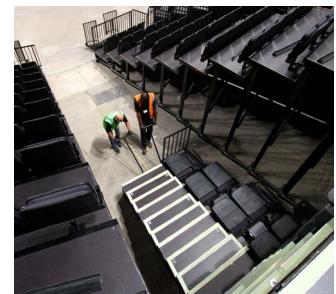

Tapered units - to help create curves and bowl shapes.

Fascias



Closed unit with no fascias

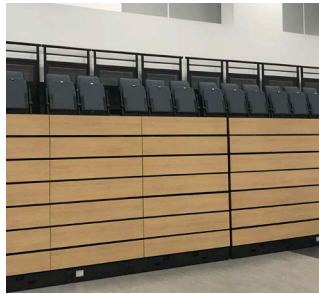

Standard fascias in 16mm plywood, double faced with melamine, finish Windsor Oak. Removable infills at aisle positions.

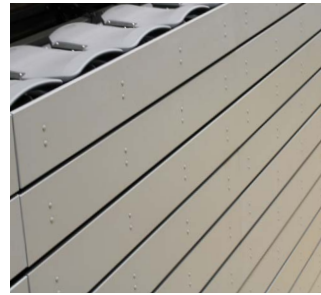

Fascias with plain melamine finish. (Those shown are through bolted for additional strength in a ball sport venue.)

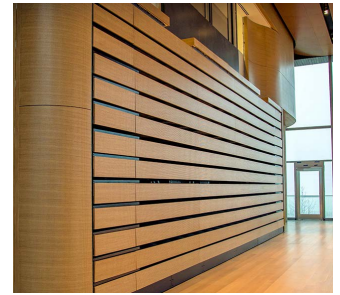

Custom finishes - please ask us about custom finishes and materials to suit your interior.

Deck Finishes and Trims



Carpet - Contract grade, heavy duty, fire retardant carpet chosen from our standard range or custom carpet if suitable.

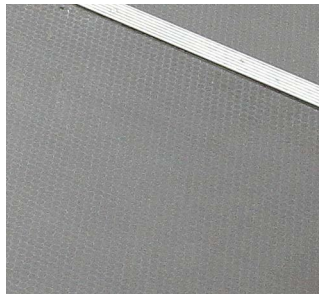

Phenolic Deck - Brown, raised pattern phenolic coating, anti-slip.



Wood Effect Deck - Hard wearing, premium grade wood effect flooring in vinyl in a wide choice of finishes.



Aisle Lights - Low voltage, low glare, LED lighting with optional one hour battery back-up and dimming function.



Row letters on step riser.



Standard Deck and Step Nosing - Aluminium profile. Shown with row letters on step tread.

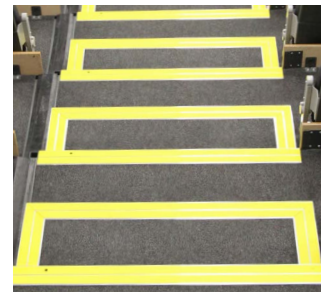

Custom Nosing - With infill to suit your interior.

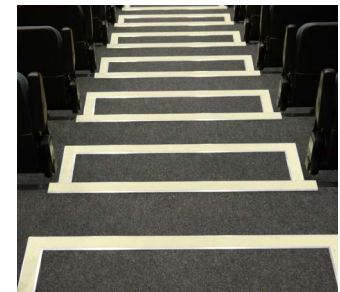

Photoluminescent Nosing.

Screening

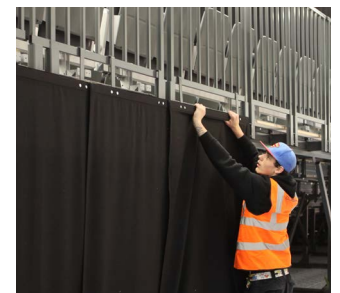

To disguise and prevent access to understructure. Removable panels are available for the side, rear and front of the seating unit (if row 1 is raised) in 16mm birch plywood with melamine facing, finish Windsor Oak. Other finishes on request. Removable drapes in FR dimout fabric are also available for the side and rear of the seating unit.

Rail Operation

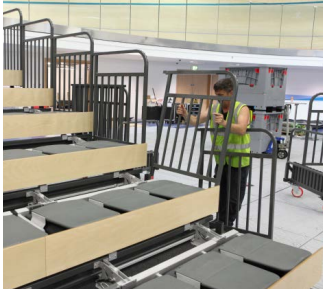

Removable Side Rails - Removed before platforms are retracted and usually stored on a trolley.*



Self-storing Side Rails - Angled to nest together when unit is retracted.



Folding Side Rails - Available where the rail is adjacent to an aisle.



Kick plates - To guard the operational clearance where an aisle is adjacent to a wall.



Front Rails.



Rear Rails.

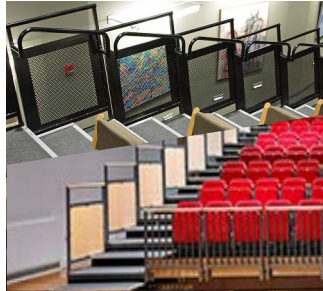

Hand rails - Top: US ICC compliant hand rails. Bottom - Wooden rail tops.



Centre Aisle Rails.

Rail Design



Type D - Tubular steel infill.



Type E - Perforated steel infill.



Type B - Plywood infill, faced with melamine (finish: Windsor Oak) - other finishes on request.



Custom - Infill panels in special materials to co-ordinate with your interior.

Other Items



Trolleys - for rails, aisle infills and any other ancillary items.

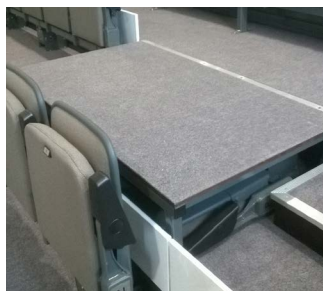

Removable plinths - typically for a sound desk or wheelchair position.



Deck infills - hinged steel, or removable rubber to create joint between two adjacent mobile units.

*Where removable rails are included, the telescopic system will include anchor points to facilitate the use of a standard restraint belt. This will ensure that system operators comply with the Working at Height Regulations 2005 when installing or removing rails.

Chairs

All chairs are folded down using a release lever prior to the platforms being retracted (left).

An optional extra row can be added to the front of the system (right).

See separate datasheets for full details of each chair, and a full list of available options.



Recital



Espace 628CC

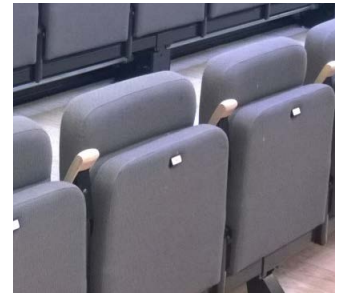

Espace 628 High Back



Espace 628

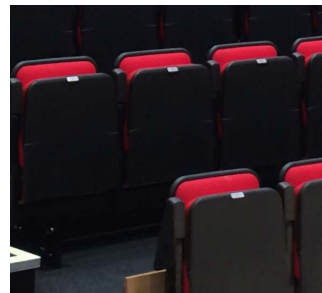

Espace 628T

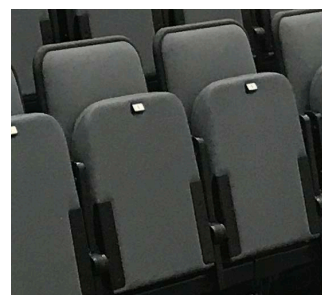

Accolade

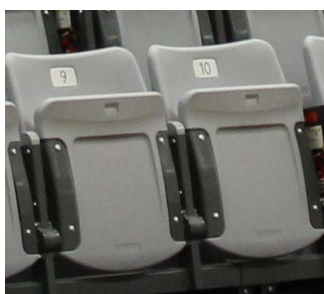

Zenith



Alpha

Material Specification

Finishes

General steelwork	Four stage iron phosphate pre-treatment and epoxy powder coating, colour RAL 9005 matt black.
Front beam	Four stage iron phosphate pre-treatment and epoxy powder coating, colour RAL 9005 matt black.
Central deck beams	Four stage iron phosphate pre-treatment and epoxy powder coating, colour RAL 9005 matt black.
Rear beam	Pre-galvanised standard or epoxy powder coating, colour RAL 9005 matt black, as option.

Specification

Column	Platform 1: 100 x 50 x 3.0mm, R.H.S (BS EN 10219-1). Platforms 2-5: 100 x 50 x 3.0mm, R.H.S. + 50 x 50 x 3.0mm S.H.S. (BS EN 10219-1).
Column foot	Pressed steel, 3mm thick (BS EN 10025) + 50 x 50 x 3.0mm S.H.S. (BS EN 10219-1) stiffener.
Wheels	100mm x 40mm wide, with polyurethane tread, c/w needle bearing (7 wheels per column).
Braces	Platforms 2-5: 50 x 45 x 2.5mm roll formed 'C' section (BS EN 10025).
Front beam	76 x 74 x t2.3mm roll formed section (Z35 steel).
Front central beam	126 x 45 x 3mm formed section (Zinc plated mild steel; EN 10147).
Rear central beam	130 x 98 x 3mm formed section (BS EN 10025).
Rear beam	175 x 50 x t2.3mm roll formed section (Zinc plated mild steel; EN 10147).
Deck boards	18mm phenolic faced, WBP combi plywood or carpeted Finnish plywood (DIN-22mm thick).
Rails	Outer framework of rail: ERW 1¼" x 1¼", 14 SWG. Vertical bars - ¾" x ¾" x 16 SWG SQ tube. Horizontal Bars - 1½" x ¾" x 16 SWG REC tube. All round tube (type E only) is ERW 38mm x 2mm. Steel Grade: BS6323 part 5: 1982 ERW1. Perforated steel sheet is to BSEN10130:1999 DC01.
Vertical load	4kN/m ² (5kN/m ² where applicable).
Horizontal load	7.5% of vertical load.
Row locks	Heavy duty, 5mm steel, foot level, automatic latch locks. Gravity operation with spring assistance. Heavy duty, 5mm steel, vertical interlock at all column tops.
Platform levels	Cantilever slide arms transfer load onto 60mm dia. nylon rollers. Platform loads are transferred through 38mm dia. nylon rollers. Loads are transferred at 2 column positions and minimum 4 support positions.
Power operation	Friction drive consisting of two 160mm dia. rubber rollers chain driven by a single or 3-phase motor. Standard motor size – 0.37kw single phase or 0.25kw 3-phase. Large units can be specified with a tandem frame incorporating two motors per unit.

Standards

Strength and stability	The TX system can be supplied to comply with most worldwide standards.
Flammability	Decks and fascias can be supplied to an appropriate FR grade if required. Standard carpet is heavy duty contract quality conforming to BS5287 (BS4790 low radius of char) and BS 13501:2002 Euroclass C _f -s1 (sheet) or Euroclass B _f -s1 (tile).

Notes

Floor construction and surface finish play an important role and greatly affect the operation of telescopic seating. A smooth, hard, level floor is an essential element, e.g. smooth concrete or hardwood are ideal surfaces. Please ask us for more details and point load information.

Full fascias are available for most standard combinations of row rise, row depth and chair type, but in a few cases only reduced height fascias may be possible. Please check with Audience Systems.

All information given above is for standard product. Please ask us about customisation.

Audience Systems Ltd reserves the right to change the design, specification or price of products without prior notice.