

LEAN[®] SYSTEM

FLEXIBLE SOLUTIONS WITH ENDLESS POSSIBILITIES



LEAN MANUFACTURING SOLUTIONS

Scaglia
1838 **INDEVA[®]**
INTELLIGENT DEVICES FOR HANDLING

A MODERN COMPANY WITH A LONG HISTORY

Scaglia INDEVA was founded in 1838 by the Scaglia family and remains in their ownership to the present day. It is the foundation stone of an important Industrial Group, which has now diversified into a wide range of commercial businesses worldwide. The headquarters is in Bergamo, Italy, and with subsidiaries in many countries.



Since the late 1990s Scaglia INDEVA has been supplying Modular Systems suitable for Lean Manufacturing. INDEVA Lean System® is manufactured in Italy and Sweden, and offers a Complete range of components for Modular Structures, such as Pipes, Joints, Roller Conveyors, Kit boxes, Accessories etc.

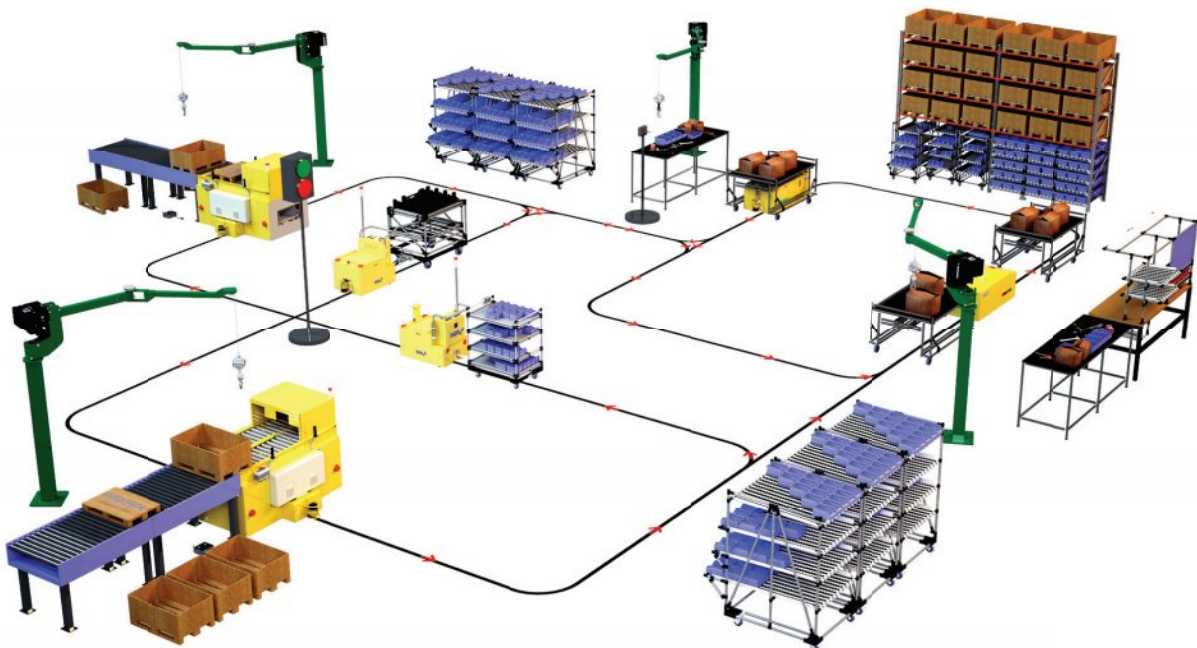

INDEVA Design & Manufacture custom made Production & Logistic equipment

LEAN MANUFACTURING

FLEXIBLE ASSEMBLY LINES & PART VARIATION

Managing part variation - from inventory to how we present it to the operator - is the biggest challenge that INDEVA face on a daily basis.

Parts kitting ensures that operators get the right part at the right time at the right workstation.



Example of sequencing of Gear stick. Thanks to optimum Ergonomics, several seconds are saved for the operator at each operation. During a single day we could save over 6000 seconds!

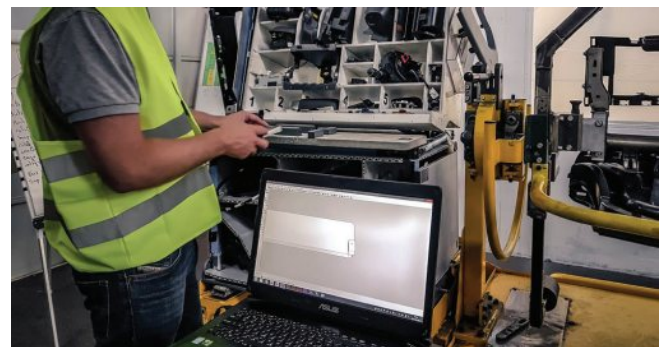

In order to reduce lead time of development, INDEVA's designers work directly on the shop floor. The actual process is analysed and 3D proposals of kitting Trolleys can immediately be suggested.



LEAN MANUFACTURING

A WIDE RANGE OF SOLUTIONS

SUPERMARKET
Modular Custom Designed
contribute to waste elimination.

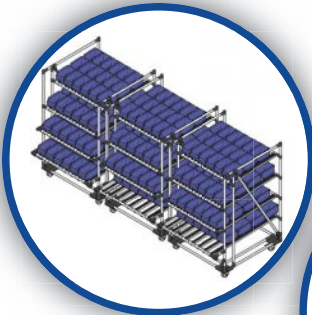

FLOW RACKS
Save time, space & increases
Work Flow Efficiency &
Ergonomics.

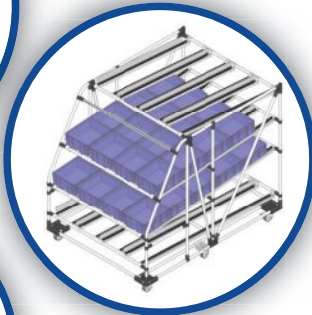

WORKSTATIONS
Adjustable &
Customizable to
improve Ergonomics &
Productivity.

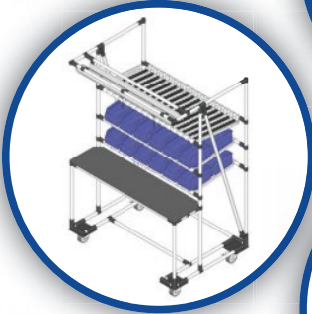

TUGGER CARTS
Efficient Transport of Material



**WORK IN PROCESS
CARTS**
Custom Designed to
accommodate all components
associated with
sub-assembly processes.



SHOOTER TROLLEYS
Safely move Heavy
loads from one Trolley
to another by means of
Gravity.

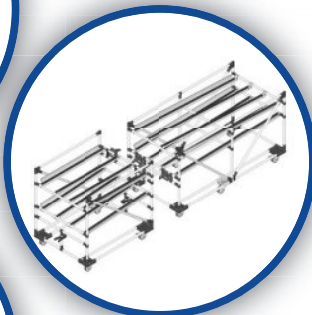

KITTING TROLLEYS
A wide Range of
tailor made solutions.

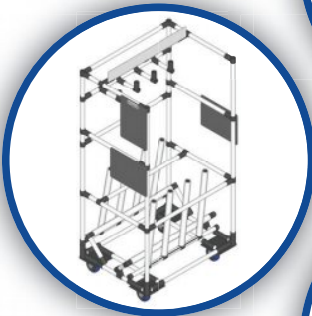

KIT BOXES
From simple to Specialized,
Large and Complex
components for all types of
Manufacturing requirements.

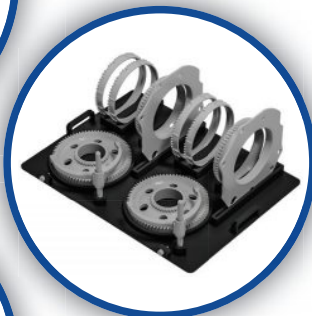

DUNNAGE BAGS
Combines Strength &
Versatility for Handling
Sensitive Parts.



A WIDE RANGE of solutions

SUPERMARKET

Modular custom Designed Supermarkets should be located near the supplying process to help maintain a Visual sense of customer usage and requirements. The different items in a supermarket have a FIFO Flow, specific location and are organized in the exact quantities in which they are needed.



- ✓ Adjustable to different configurations
- ✓ Easy to move to point of need
- ✓ Elimination of waste both in time & space
- ✓ Replaces use of lift trucks & eliminates related safety hazard.



A WIDE RANGE of solutions

FIFO GRAVITY FLOW RACKS

INDEVA's wide range of Gravity Flow Rack allows us to Design and deliver the optimum solutions for each specific requirement.

- ✓ Saves time, space & labour.
- ✓ Provides high density storage.
- ✓ Shelves can be adjusted to meet product dimensions.
- ✓ Reduces loading and unloading congestion.
- ✓ Cost efficient.



Type 1



Type 2



Type 3



Type 4



Type 5



Type 6

A WIDE RANGE of solutions

WORKSTATIONS

INDEVA Lean System® allows you to Design Ergonomic Workstations to suit your production requirement. INDEVA offer a wide range of individual solutions which can be tailored precisely to your requirements.

- ✓ More flexible response to customers' needs
- ✓ Quicker quality feedback
- ✓ Less space required
- ✓ Reduction in inventory and intermediate storage
- ✓ Shorter processing times
- ✓ Increased productivity
- ✓ Better working environment
- ✓ Reduction in overall costs

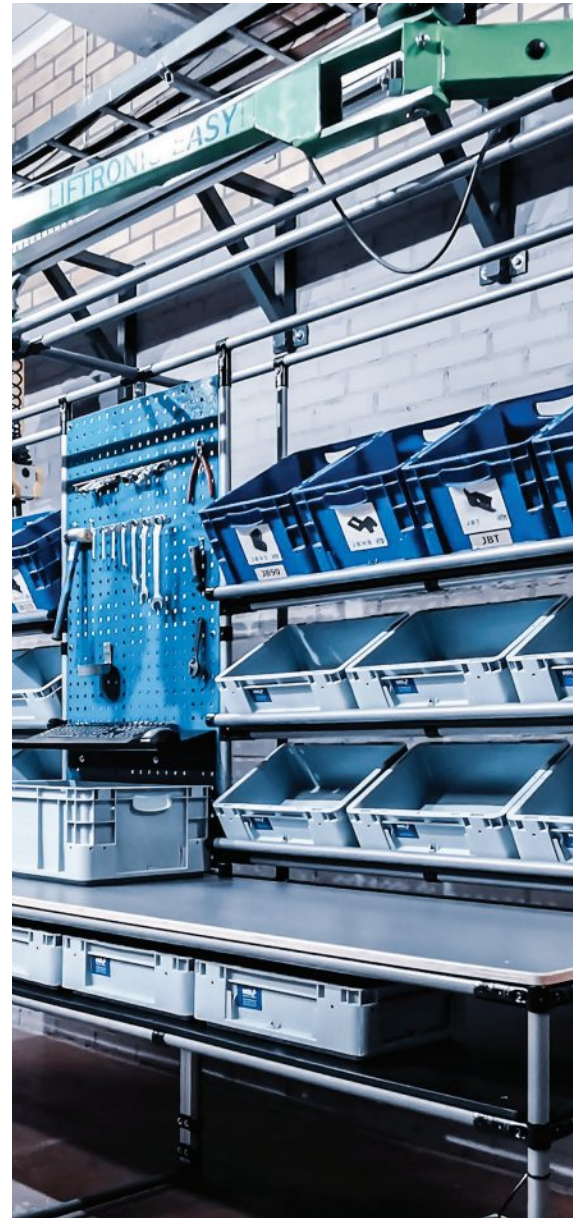

A WIDE RANGE of solutions

TUGGER CARTS

Custom made Tugger Carts from INDEVA are efficient for transporting material

✓ No need for forklifts

✓ Less Floor Congestion

✓ Reduced Wait Times



A WIDE RANGE of solutions

WORK IN PROCESS CARTS

INDEVA Lean System® is ideal for the Design & Assembly of Customized Material Handling Carts.

- ✓ Ergonomic presentation of parts
- ✓ Manufactured for specific needs



A WIDE RANGE of solutions

SHOOTER TROLLEYS

To safely move heavy loads from one trolley to another by means of gravity. Shooter trolleys made with INDEVA Lean System® allow the safe movement of heavy loads from one trolley to another or from one fixed structure to a cart.

- ✓ Significant reduction of health & safety hazards
- ✓ Significant improvement of production efficiency
- ✓ Enhancement of storage processes with the implementation of just-in-time parts supply.

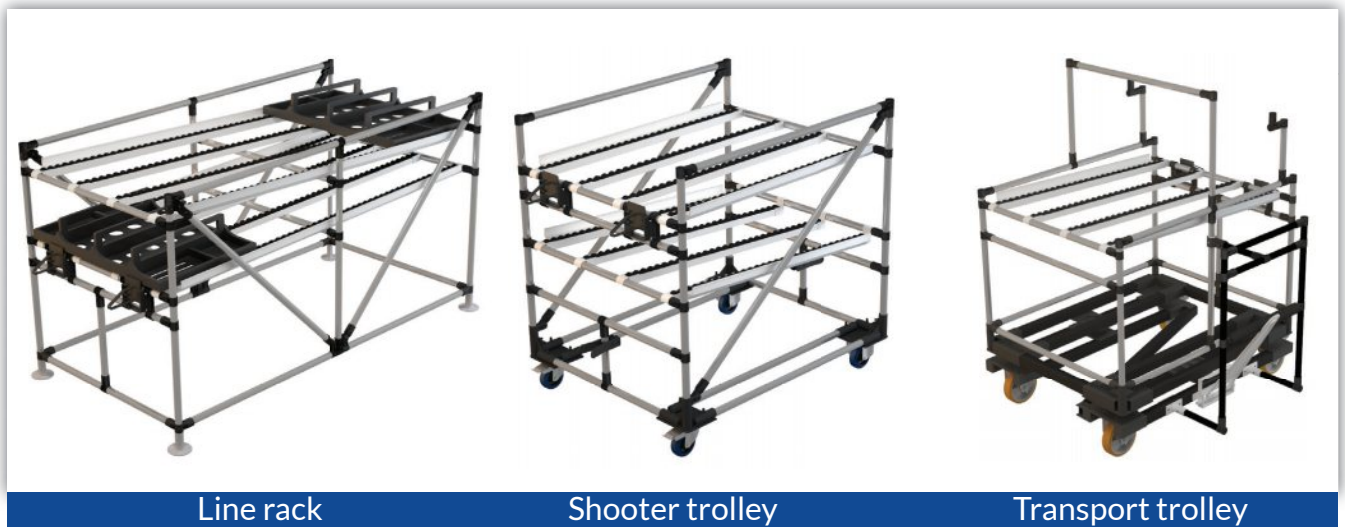

Line rack

Shooter trolley

Transport trolley



A WIDE RANGE of solutions

KITTING TROLLEYS

INDEVA Design & Manufacture kitting solutions. Using kitting as your main material feeding system reduces the time handlers & operators will look for certain parts or components due to all parts arriving within a kit.

- ✓ Elimination of "Search Time"
- ✓ Improved Organization on the Production Line
- ✓ Improved Logistic Management



Sensitive parts



Special parts



A WIDE RANGE of solutions

KIT BOXES

A wide range of tailor-made storage and presentation solutions. From simple to complex, from small to large, we provide kit boxes to suit any manufacturing requirement. Using kit boxes is recommended for Lean Manufacturing.

- ✓ Elimination of “Search Time”
- ✓ Improved Organization on the Factory Floor
- ✓ Improved Logistic Management



A WIDE RANGE of solutions

DUNNAGE BAGS TROLLEYS

Ideal for Automotive Assembly and Appliance manufacturing to safely transport lightweight components. The unique design of INDEVA's Dunnage bags combines strength and versatility for handling sensitive parts. Possible access on one or two sides depending on the size of the products being transported.

- ✓ There is no limit to the types of configurations
- ✓ No dust or scratches on the parts, even during transport



SUPPLY OPTIONS

SUPPLY OF ASSEMBLED STRUCTURES

Once INDEVA's 3D Drawing is approved, your order is Manufactured at INDEVA's facility and, Delivered Direct to you Ready for Use.



TURN-KEY SUPPLY WITH LEAN TECHNICIAN

No need for pre-study, INDEVA assess your needs and Manufacture a Prototype. Solution for immediate use, with full flexibility to alter after evaluation.



Assembly process from parts to solutions

SUPPLY OPTIONS

SUPPLY OF KITTED STRUCTURES

Using 3D simulation our Engineers Design & Build a Prototype. After customer Approval & Acceptance, your order is Assembled at our Facility and Delivered directly to your location, Ready for Use.

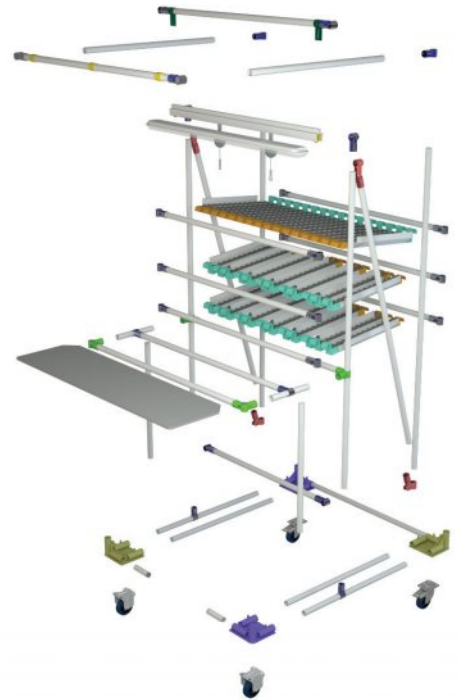
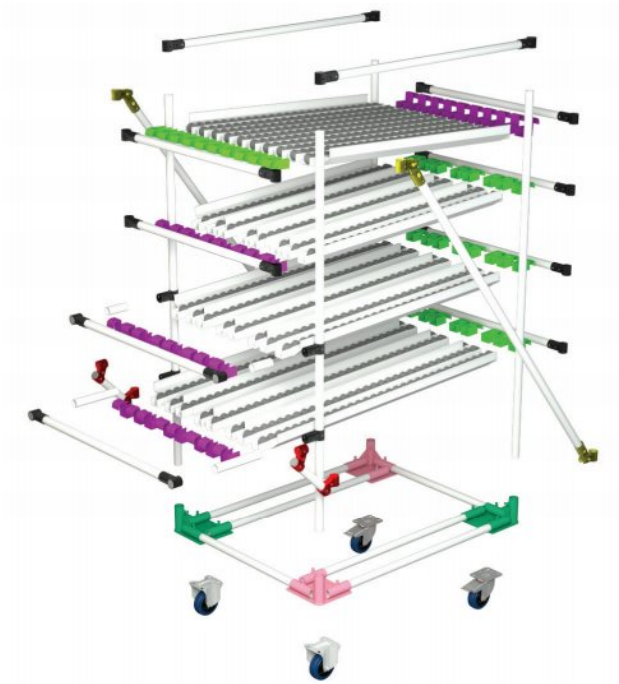

SUPPLY OF BULK COMPONENTS

Who knows your need better than yourself? INDEVA® guarantee quick delivery of our wide range of components.





Scaglia INDEVA
Italy

Scaglia INDEVA SpA
Headquarters and Production Unit
Via Marconi, 42
24012 Val Brembilla (BG)
Tel. +39 0345 59 411
Fax +39 0345 59 500
info@it.indevagroup.com
www.indevagroup.it



Scaglia INDEVA
Germany

Scaglia INDEVA GmbH
Esslinger Str. 26
D-73249 Wernau
Tel.+49 (0) 7153 55049-0
Fax +49 (0) 7153 55049-69
info@de.indevagroup.com
www.indevagroup.de



Scaglia INDEVA
France

Scaglia INDEVA SARL
215 Rue Henry Barbusse
95100 Argenteuil
Tel.: +33 (0) 1 39 19 30 30
Fax: +33 (0) 1 39 19 63 24
info@fr.indevagroup.com
www.indevagroup.fr



Scaglia INDEVA
United Kingdom

Scaglia INDEVA Ltd
Coney Green Business Centre, Clay Cross
Chesterfield, Derbyshire S45 9JW
Tel. +44 (0) 1246 25 23 33
Fax +44 (0) 1246 25 23 34
info@uk.indevagroup.com
www.indevagroup.co.uk



Scaglia INDEVA
Sweden

SCAGLIA INDEVA Nordic AB
Torbornavägen 24
253 68 Helsingborg
Tel. +46 (0) 424002460
info@se.indevagroup.com
www.indevagroup.se



SIT INDEVA
United States

S.I.T. INDEVA Inc.
3630 Green Park Circle
Charlotte, NC 28217
Tel. +1 704 357 8811
Fax +1 704 357 8866
info@sit-indeva.com
www.indevagroup.com



SIT INDEVA
P. R. of China

SIT INDEVA (Shanghai) Ltd
Shanghai Nanhui Industrial Park
#2 Building, No 269 YuanZhong Rd. 201300
Tel. +86 (21) 5108 2206 - 137
Fax +86(21) 6486 3511
info@cn.indevagroup.com
www.indevagroup.cn



Scaglia INDEVA
Russia

Scaglia INDEVA Rus LLC
Moscow, Kaluzhskoye shosse,
23-y kilometr, 14c3, office 90-91, Russia
Tel. +7 (812) 4495016
info@ru.indevagroup.com
www.indevagroup.ru



INTELLIGENT DEVICES FOR HANDLING