

MS6000 MKII

User's Guide

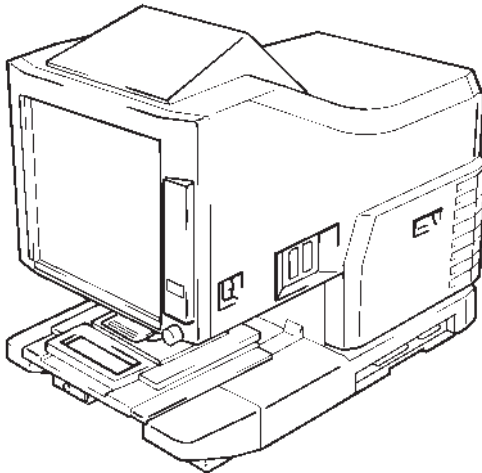

SAFETY INFORMATION



This section contains detailed instructions on the operation and maintenance of this machine. To achieve optimum utility of this device, all operators should carefully read and follow the instructions in this manual. Please keep this manual in a handy place near the machine.

Make sure you observe all of the precautions listed in this manual.

* Ver07

Please note that some parts of the contents of this section may not correspond with the purchased product.

Warning and Precaution Symbols

 WARNING:	Ignoring this warning could cause serious injury or even death.
 CAUTION:	Ignoring this caution could cause injury or damage to property.

Meaning of Symbols



A triangle indicates a danger against which you should take precaution.



This symbol warns against cause burns.



A diagonal line indicates a prohibited course of action.



This symbol warns against dismantling the device.



A black circle indicates an imperative course of action.



This symbol indicates you must unplug the device.

SAFETY INFORMATION

⚠ WARNING

- Do not modify this product, as a fire, electrical shock, or breakdown could result. If the product employs a laser, the laser beam source could cause blindness.
- Do not attempt to remove the covers and panels which have been fixed to the product. Some products have a high-voltage part or a laser beam source inside that could cause an electrical shock or blindness.



- Only use the power cord supplied in the package. If a power cord is not supplied, only use the power cord and plug that is specified in POWER CORD INSTRUCTION. Failure to use this cord could result in a fire or electrical shock.
- Use the power cord supplied in the package only for this machine and NEVER use it for any other product. Failure to observe this precaution could result in a fire or electrical shock.
- Use only the specified power source voltage. Failure to do that could result in a fire or electrical shock.
- Do not use a multiple outlet adapter to connect any other appliances or machines. Use of a power outlet for more than the marked current value could result in a fire or electrical shock.



Do not unplug and plug in the power cord with a wet hand, as an electrical shock could result.



Plug the power cord all the way into the power outlet. Failure to do this could result in a fire or electrical shock.



- Do not scratch, abrade, place a heavy object on, heat, twist, bend, pull on, or damage the power cord. Use of a damaged power cord (exposed core wire, broken wire, etc.) could result in a fire or breakdown.
Should any of these conditions be found, immediately turn OFF the power switch, unplug the power cord from the power outlet, and then call your authorized service representative.
- Do not use an extension cord, in principle. Use of an extension cord could cause a fire or electrical shock. Contact your authorized service representative if an extension cord is required.

SAFETY INFORMATION



Do not place a flower vase or other container that contains water, or metal clips or other small metallic objects on this product. Spilled water or metallic objects dropped inside the product could result in a fire, electrical shock, or breakdown.

Should a piece of metal, water, or any other similar foreign matter get inside the product, immediately turn OFF the power switch, unplug the power cord from the power outlet, and then call your authorized service representative.



- Do not keep using this product, if this product becomes inordinately hot or emits smoke, or unusual odor or noise. Immediately turn OFF the power switch, unplug the power cord from the power outlet, and then call your authorized service representative. If you keep on using it as is, a fire or electrical shock could result.
- Do not keep using this product, if this product has been dropped or its cover damaged. Immediately turn OFF the power switch, unplug the power cord from the power outlet, and then call your authorized service representative. If you keep on using it as is, a fire or electrical shock could result.



Do not throw the toner cartridge or toner into an open flame. The hot toner may scatter and cause burns or other damage.



Connect the power cord to an electrical outlet that is equipped with a grounding terminal.

SAFETY INFORMATION

 **CAUTION**

- Do not use flammable sprays, liquids, or gases near this product, as a fire could result.
- Do not leave a toner unit or drum unit in a place within easy reach of children. Licking or ingesting any of these things could injure your health.
- Do not let any object plug the ventilation holes of this product. Heat could accumulate inside the product, resulting in a fire or malfunction.
- Do not install this product at a site that is exposed to direct sunlight, or near an air conditioner or heating apparatus. The resultant temperature changes inside the product could cause a malfunction, fire, or electrical shock.
- Do not place the product in a dusty place, or a site exposed to soot or steam, near a kitchen table, bath, or a humidifier. A fire, electrical shock, or breakdown could result.
- Do not place this product on an unstable or tilted bench, or in a location subject to a lot of vibration and shock. It could drop or fall, causing personal injury or mechanical breakdown.
- After installing this product, mount it on a secure base. If the unit moves or falls, it may cause personal injury.
- Do not store toner units and PC drum units near a floppy disk or watch that are susceptible to magnetism. They could cause these products to malfunction.



The inside of this product has areas subject to high temperature, which may cause burns. When checking the inside of the unit for malfunctions such as a paper misfeed, do not touch the locations (around the fusing unit, etc.) which are indicated by a "CAUTION HOT" caution label.



Do not place any objects around the power plug as the power plug may be difficult to pull out when an emergency occurs.



The socket-outlet shall be installed near the machine and shall be easily accessible as the power plug may be difficult to pull out when an emergency occurs.

CAUTION



- Always use this product in a well ventilated location. Operating the product in a poorly ventilated room for an extended period of time could injure your health. Ventilate the room at regular intervals.
- Whenever moving this product, be sure to disconnect the power cord and other cables. Failure to do this could damage the cord or cable, resulting in a fire, electrical shock, or breakdown.
- When moving this product, always hold it by the locations specified in the operator's manual or other documents. If the unit falls it may cause severe personal injury. The product may also be damaged or malfunction.
- Remove the power plug from the outlet more than one time a year and clean the area between the plug terminals. Dust that accumulates between the plug terminals may cause a fire.
- When unplugging the power cord, be sure to hold onto the plug. Pulling on the power cord could damage the cord, resulting in a fire or electrical shock.

Precautions for Routine



- Do not store toner units, PC drum units, and other supplies and consumables in a place subject to direct sunlight and high temperature and humidity, as poor image quality and malfunction could result.
- Do not attempt to replace the toner unit and PC drum unit in a place exposed to direct sunlight. If the PC drum is exposed to intense light, poor image quality could result.
- Do not unpack a toner unit or PC drum unit until the very time of use. Do not leave an unpacked unit standing. Install it immediately or poor image quality could result.
- Do not keep toner units and PC drum units in an upright position or upside down, as poor image quality could result.
- Do not throw or drop a toner unit or PC drum unit as poor image quality could result.
- Do not use this product in an area where ammonia or other gases or chemicals are present. Failure to do so may shorten the service life of the product, cause damage or decrease performance.
- Do not use this product in an environment with a temperature outside the range specified in the operator's manual, as a breakdown or malfunction could result.
- Do not attempt to feed stapled paper, carbon paper or aluminum foil through this product, as a malfunction or fire could result.

SAFETY INFORMATION



Do not touch or scratch the surface of the toner unit developing roller and the PC drum, as poor image quality could result.



Use the supplies and consumables recommended by the dealer. Use of any supply or consumable not recommended could result in poor image quality and breakdown.

Welcome

This User's Guide explains how to operate the unit and replenish its supplies. It also gives some troubleshooting tips as well as general precautions to be observed when operating the unit.

To ensure the best performance and effective use of your unit, read this User's Guide carefully until you familiarize yourself thoroughly with the unit's operation and features.

Please keep this User's Guide and use it as a quick and handy reference tool for immediately clarifying any questions that may arise.

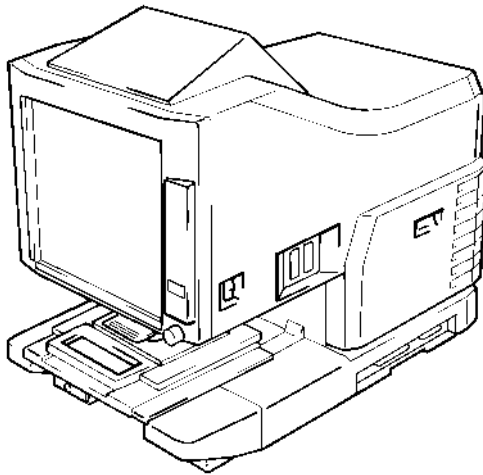

Please follow the instructions given in this User's Guide when handling the system and do not touch any part of the system the User's Guide does not cover.

NEVER attempt to disassemble or remodel the system.

The contents of this User's Guide are subject to change without notice.

No part of this User's Guide may be quoted, reproduced, or translated into any other language.

Notes to Operators and Key Operators

The following safety rules should be observed:

- [1] The unit should be kept free from moisture, dirt, dust and exposure to heat and direct sunlight at all times.
- [2] Keep hands, hair and clothing away from rollers and other moving parts.
- [3] Before removing the Projection Lamp Unit, confirm that the machine is turned "OFF".
- [4] Be sure that the proper voltage is used and that the machine is well grounded. The use of electrical extension cords is strongly discouraged.
- [5] For best performance, only our authorized supplies are recommended for use with this unit. Failure to use our authorized supplies may cause damage to the unit, in which case the warranty may be rendered void.
- [6] Do not attempt to remove any Cover that is secured.

FCC Part 15 - Radio Frequency Devices (For U.S.A. Users)

This device complies with Part 15 of the FCC Rules.

Operation is subject to the following two conditions:

1. This device may not cause harmful interference, and
2. this device must accept any interference received, including interference that may cause undesired operation.

WARNING

This equipment has been tested and found to comply with the limits for a Class A digital device, pursuant to Part 15 of the FCC Rules. These limits are designed to provide reasonable protection against harmful interference when the equipment is operated in a commercial environment. This equipment generates, uses, and can radiate radio frequency energy and, if not installed and used in accordance with the instruction manual, may cause harmful interference to radio communications. Operation of this equipment in a residential area is likely to cause harmful interference in which case the user will be required to correct the interference at his own expense.

The design and production of this unit conforms to FCC regulations, and any changes or modifications must be registered with the FCC and are subject to FCC control. Any changes made by the purchaser or user without first contacting the manufacturer will be subject to penalty under FCC regulations.

**Interference-Causing Equipment Standard (ICES-003 ISSUE 4)
(For Canada Users)**

This Class A digital apparatus complies with Canadian ICES-003.

Cet appareil numérique de la classe A est conforme à la norme NMB-003 du Canada.

CE Marking (Declaration of Conformity) (For European Users)

This product complies with the following EU directives:

2006/95/EC and 2004/108/EC directives.

This declaration is valid for the area of the European Union(EU) only.

This device must be used with shielded interface cable and shielded network cable.

The use of non-shielded cable is likely to result in interference with radio communications and is prohibited under rules.

Acoustic Noise

Machine Noise Regulation 3 GSGV, 18.01.1991: The sound pressure level at the operator position according to EN27779 is equal to or less than 70dB (A).

Safety Information (MSP 3500 Printer)

Laser Safety

This printer is a page printer which operates by means of a laser. There is no possibility of danger from the laser, provided the printer is operated according to the instructions provided in this manual.

Since radiation emitted by the laser is completely confined within protective housing and external covers, the laser beam cannot escape from the machine during any phase of user operation.

This printer is certified as a Class 1 laser product: This means that the printer does not produce hazardous laser radiation.

Internal Laser Radiation

Maximum Average Radiation Power	37 μ W at laser Aperture of mirror unit
Wave Length	770-800 nm

This product employs a Class IIIb Laser Diode that has an invisible laser beam. The Laser Diode and Scanning Polygon Mirror are incorporated in the print head unit.

The print head (in the interior of the printer in front of the toner cartridge) consists of the print head unit and the mirror unit. The laser beam is emitted from the print head unit, passes through the mirror unit, then is radiated through the laser aperture of the mirror unit to the interior of the printer.

WARNING

The print head unit is NOT A FIELD SERVICE ITEM. Therefore, the print head unit should not be opened under any circumstances.

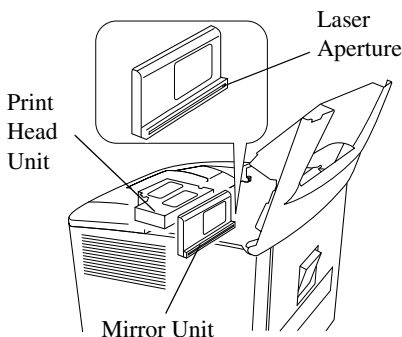

For United States

CDRH Regulations

This printer is certified as a Class I laser product under the Regulation Performance Standard according to the Food, Drug, and Cosmetic Act of 1990.

Compliance is mandatory for laser products marketed in the United States, and is reported to the Center for Devices and Radiological Health (CDRH) of the U.S. Food and Drug Administration (FDA) of the Department of Health and Human Services (DHHS). This means that the product does not produce hazardous laser radiation.

The label shown below indicated compliance with the CDRH regulations and must be attached to laser products marketed in the United States.

CAUTION: Use of controls, adjustments or performance of procedures other than those specified in this manual may result in hazardous radiation exposure.

This is a semiconductor laser. The maximum power of the laser diode is 15mW, and the wavelength is 770-800 nm.

All other users

WARNING: Use of controls, adjustments of performance or procedures other than those specified in this manual may result in hazardous radiation exposure.

This is a semiconductor laser. The maximum power of the laser diode is 15mW, and the wavelength is 770-800 nm.

For Denmark

ADVARSEL: Usynlig laserstråling ved åbning, når sikkerhedsafbrydere er ude af funktion. Undgå udstelse for stråling.
Klasse 1 laser produkt der opfylder IEC60825 sikkerheds kravene.

Safety Information (MSP 3500 Printer)

For Finland, Sweden

VAROITUS!: Laitteen käyttäminen muulla kuin tässä käyttöohjeessa mainitulla tavalla saattaa altistaa käyttäjän turvallisuusluokan 1 ylittävälle näkymättömälle lasersäteilylle.

WARNING: Om apparaten används på annat sätt än i denna bruksanvisning specificerats, kan användaren utsattas för osynlig laserstrålning, som överskrider gränsen för laserklass 1.

VARO: Avattaessa ja suojalukitus ohitettaessa olet alttiina näkymättömälle lasersäteilylle. Aja katso sateeseen.

WARNING: Osynlig laserstråining när denna del är öppnad och spärren är urkopplad. Be-trakta ej stråien.

For Norway

ADVARSEL: Dersum apparatet brukes på annen måte enn spesifisert i denne bruksanvisning, kan brukeren utsettes for usynlig laserstråling som overskrider grensen for laser klasse 1.

Dette er en halvleder laser. Maksimal effekt til laserdiode er 15mW, og bølgelengde er 770-800 nm.

WARNING LABEL

- Three laser caution labels are attached to the inside of the machine as shown below.

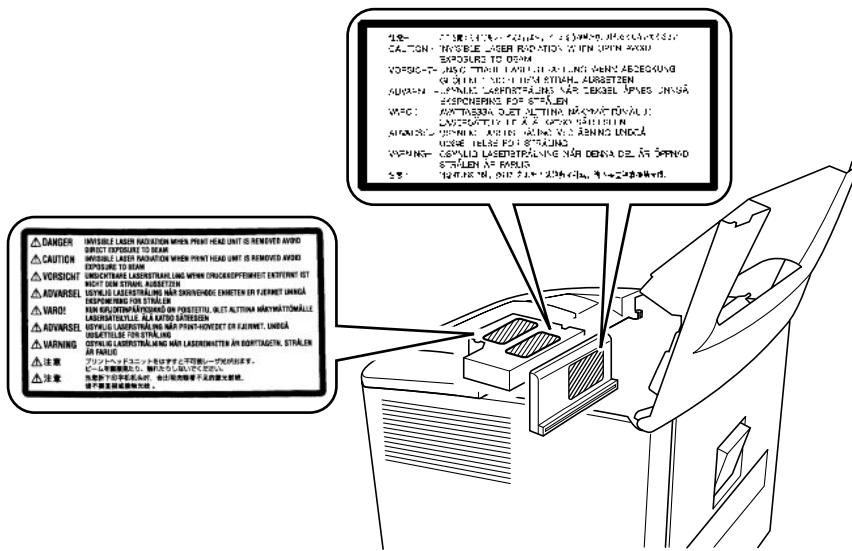

Safety Information (MSP 3500 Printer)

OZONE RELEASE (For all Users)

During printer operation, a small quantity of ozone is released. This amount is not large enough to cause any adverse affects or harm. However, be sure the room where the machine is being used has adequate ventilation, especially if you are printing a high volume of materials, or if the machine is being used continuously over a long period.

WARNING LABEL

- A laser safety label is attached to the outside of the machine as shown below.

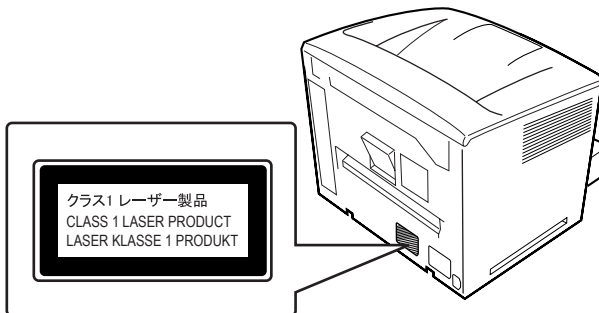

Safety Information (MSP 3000 Printer)

Laser Safety

This printer is a page printer which operates by means of a laser. There is no possibility of danger from the laser, provided the printer is operated according to the instructions provided in this manual.

Since radiation emitted by the laser is completely confined within protective housing, the laser beam cannot escape from the machine during any phase of user operation.

Internal Laser Radiation

Maximum Radiation Power: 8.8×10^{-4} (W)

Wave Length: 770-810 (nm)

This is a Class IIb Laser Diode Assy. that has an invisible laser beam. The print head unit is NOT A FIELD SERVICE ITEM. Therefore, the print head unit should not be opened under any circumstances.

For United States

Laser Safety

This printer is certified as a Class 1 Laser product under the **U.S. Department of Health and Human Service (DHHS)** Radiation Performance Standard according to the Radiation Control for Health and Safety Act of 1968. This means that the printer does not produce hazardous laser radiation.

CDRH Regulations

The **Center for Devices and Radiological Health (CDRH)** of the U.S. Food and Drug Administration implemented regulations for laser products on August 2, 1976. These regulations apply to laser products manufactured from August 1. Compliance is mandatory for products marketed in the United States. The label shown below indicates compliance with the CDRH regulations and must be attached to laser products marketed in the United States.

WARNING: Use of controls, adjustments or performance of procedures other than those specified in this manual may result in hazardous radiation exposure.

All other users

WARNING: Use of controls, adjustments of performance or procedures other than those specified in this manual may result in hazardous radiation exposure.

This is a semiconductor laser. The maximum power of the laser diode is 8.8×10^{-4} W and the wavelength is 770-810 nm.

Safety Information (MSP 3000 Printer)

For Denmark

ADVARSEL: Usynlig laserstråling ved åbning, når sikkerhedsafbrydere er ude af funktion. Undgå udstelse for stråling.
Klasse 1 laser produkt der opfylder IEC60825 sikkerheds kravene.

For Finland, Sweden

VAROITUS!: Laitteen käyttäminen muulla kuin tässä käyttöohjeessa mainitulla tavalla saattaa altistaa käyttäjän turvallisuusluokan 1 ylittävälle näkymättömälle lasersäteilylle.

WARNING: Om apparaten används på annat sätt än i denna bruksanvisning specificerats, kan användaren utsattas för osynlig laserstråling, som överskrider gränsen för laserklass 1.

VARO: Avattaessa ja suojalukitus ohitettaessa olet alttiina näkymättömälle lasersäteilylle. Aja katso sateeseen.

WARNING: Osynlig laserstråling när denna del är öppnad och spärren är urkopplad. Betrakta ej strålen.

For Norway

ADVARSEL: Dersum apparatet brukes på annen måte enn spesifisert i denne bruksanvisning, kan brukeren utsettes for usynlig laserstråling som overskrider grensen for laser klasse 1.

Dette er en halvleder laser. Maksimal effeekt til laserdioder er $8.8 \times 10^{-4} \text{W}$ og bolgelengde er 770-810 nm.

WARNING LABEL

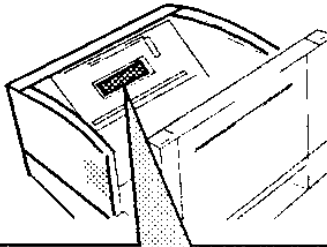

注意-	ここを開くと不明なレーザー光が出ます。ビームを直接見たり、照らしたりしないでください。
CAUTION-	INVISIBLE LASER RADIATION WHEN OPEN AVOID EXPOSURE TO BEAM
VORSICHT-	UNSICHTBARE LASERSTRAHLUNG WENN ABDECKUNG GEÖFFNET NICHT DEM STRAHL AUSSETZEN
ADVARSEL-	USYNLIG LASERSTRÅLING NÅR DEKSEL ÅPNES UNNGÅ EKSPONERING FOR STRÅLEN
VARO!	AVATTAESSA OLET ALTTIINA NÄKYMÄTTÖMÄLLE LASERSÄTELYLLE ÄLÄ KATSO SÄTEESEEN
ADVARSEL-	USYNLIG LASERSTRÅLING VED ÅBNING UNDGÅ UDSÆTTELSE FOR STRÅLING
WARNING-	OSYNLIG LASERSTRÅLING NÅR DENNA DEL ÄR ÖPPNAD STRÅLEN ÄR FARLIG
注意:	当您打开这里时, 会出现肉眼看不见的激光射线, 请不要直视或接触光线。

Safety Information (MSP 3000 Printer)

OZONE RELEASE (For all Users)

During printer operation, a small quantity of ozone is released. This amount is not large enough to cause any adverse affects or harm. However, be sure the room where the machine is being used has adequate ventilation, especially if you are printing a high volume of materials, or if the machine is being used continuously over a long period.

WARNING LABEL

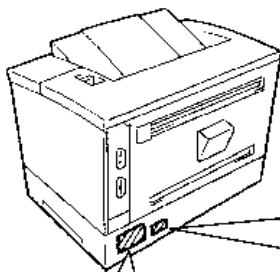

KONICA MINOLTA BUSINESS TECHNOLOGIES, INC.
 1-6-1, Morinouchi, Chiyoda-ku, Tokyo, Japan

MANUFACTURED:
 THIS PRODUCT COMPLIES WITH 21 CFR
 CHAPTER I, SUBCHAPTER J.

152A7072-04

<p>WARNING This device complies with the requirements of the FCC Rules, part 15 of subpart B of Ch. 18 of Pt. 15 of the radio frequency portion of part 15 of the FCC Rules. It does not emit radio frequency energy in excess of the limits set forth in the FCC Rules, part 15.207.</p> <p>• This Class 1 Laser Product meets all requirements of the Canadian Interference-causing Device Act.</p> <p>• Cet appareil respecte les exigences de la norme de la Commission des Radiocommunications sur les appareils de Classe 1.</p>	<table border="1"> <tr><td>Model</td><td colspan="3">MSP 3000</td></tr> <tr><td>Input</td><td>230 V~</td><td>50 Hz</td><td></td></tr> <tr><td>Total</td><td>750 W</td><td>4.0 A</td><td></td></tr> </table> <p style="text-align: center;"> LISTED ENEC 1,7E, C </p> <p>Serial No. KONICA MINOLTA BUSINESS TECHNOLOGIES, INC. Made In Japan</p>	Model	MSP 3000			Input	230 V~	50 Hz		Total	750 W	4.0 A	
Model	MSP 3000												
Input	230 V~	50 Hz											
Total	750 W	4.0 A											

Model	MSP 3000		
Input	230 V~	50 Hz	
Total	750 W	4.0 A	

Serial No.
 KONICA MINOLTA BUSINESS TECHNOLOGIES, INC. Made In Japan

Contents

Chapter 1	Safety Notes.....	1-1
	1. Installation Precautions	1-2
	Installation Site	1-2
	Power Source	1-2
	Grounding	1-2
	Space Requirements	1-3
	Operating Environment	1-5
	Using the Printer	1-5
	Care of Printer Supplies	1-5
	2. Turning the Power On and Off	1-6
	Turning ON	1-6
	Turning OFF	1-7
	3. Auto Power Save Mode	1-8
Chapter 2	Scanner	2-1
	1. System Overview	2-2
	System Configuration	2-3
	2. Parts of the Scanner	2-4
	3. Control Panel Keys and Indicators	2-5
	Control Panel (Basic)	2-5
	Control Panel (Shift Function)	2-11
	When (Misfeed/Call-Tech.-Rep. Code) Lights up	2-13
	4. Image Processing Functions	2-17
	5. Printing/Scanning	2-19
	6. Selecting a Projection Lens	2-20
	7. Replacing the Projection Lens	2-21
	8. Zooming and Focusing	2-22
	Zooming of the Screen Image	2-22
	Focusing of the Screen Image	2-22
	9. Image Rotation	2-23
	Auto Image Rotation:	2-23
	10. Selecting the Film Type	2-24
	Auto	2-24
	Nega (negative film)	2-24
	Posi (positive film)	2-24
	11. Selecting the Image Density	2-25
	Using Auto Exposure	2-25
	Using Manual Exposure	2-25
	12. Setting the Number of Prints to be Made	2-26
	To Entry the Number of Prints	2-26
	Correcting Entry	2-26

13. Selecting the Output Format	2-27
Selecting the paper source	2-27
Selecting the print format	2-28
14. Using Auto Masking	2-29
Selecting Auto Masking	2-29
Operating Conditions for Auto Masking	2-29
15. Manual Masking Panels (Optional)	2-30
16. Using Manual Masking	2-31
Selecting Trimming	2-31
Defining the Print Area	2-31
Clearing a Defined Print (Scan) Area	2-32
Selecting Masking	2-32
17. Using Centering and Fit	2-33
Centering	2-33
Fit	2-33
18. Using the Cycle Print Mode	2-34
Specifying the interval between scanning operations	2-34
Operating in the Cycle Print Mode	2-35
19. Selecting the Connection Mode	2-36
20. Selecting the Resolution	2-37
21. Registering the Job Program	2-38
22. Calling the Job Program	2-39
23. Using the Electrical Zoom	2-40
Zoom +	2-40
Zoom -	2-40
Clearing the Zoom magnification	2-41
24. Adjusting the Illumination of the Screen	2-42
25. Replacing the Projection Lamp	2-43

Chapter 3 MSP 3500 Printer 3-1

1. Parts of the Printer	3-2
2. Paper Specifications	3-4
3. Set the Paper	3-5
Loading Paper into the Paper Feeding Tray	3-5
Loading Paper in the Paper Cassette	3-6
4. Replacing the Toner Cartridge	3-9
5. Replacing the Exhaust Filter	3-12
6. When the Paper Misfeed Indicator Lights Up	3-13
If the Misfeed Indicator lights up along with a P0 code:	3-13
If the Misfeed Indicator lights up along with a P1, P2 or P3 code:	3-13

	Clearing a Misfeed from the Paper Feeding Tray	3-14
	Clearing a Misfeed from the Paper Cassette	3-15
	Clearing a Misfeed from inside the Printer	3-16
	Clearing a Misfeed from output bin	3-18
Chapter 4	MSP 3000 Printer	4-1
	1. Parts of the Printer	4-2
	2. Paper Specifications	4-4
	Use only the following types of paper	4-4
	3. Set the Paper	4-5
	Loading Paper into the Paper Feeding Tray	4-5
	Loading Paper in the Paper Cassette	4-6
	4. Replacing the Toner Cartridge	4-7
	5. When the Paper Misfeed Indicator Lights Up	4-9
	If the Misfeed Indicator lights up along with a P0 code: ...	4-9
	If the Misfeed Indicator lights up along with a P1, P2 or P3	
	code:	4-9
	Clearing a Misfeed from the Paper Feeding Tray	4-10
	Clearing a Misfeed from the Paper Cassette	4-11
	Clearing a Misfeed from inside the Printer	4-12
Chapter 5	Troubleshooting.....	5-1
	1. Solving Irregular Printing Problems	5-2
Chapter 6	Maintenance.....	6-1
	1. System Care	6-2
	Cleaning the Scanner Screen	6-2
	Outer Covers	6-2
	Carrier Glass (Option)	6-2
	Cleaning the System Printer (Option)	6-3
	Cleaning the MSP 3500 Printer	6-3
	Cleaning the Printer Exterior	6-4
	Cleaning the Printer Interior	6-4
	Paper Pickup Rollers	6-5
	Cleaning the MSP 3000 Printer	6-8
Chapter 7	Miscellaneous	7-1
	1. Specifications	7-2
	PC Mode	7-3
	PR Mode : MSP 3500 Printer	7-3

Contents

PR Mode : MSP 3000 Printer	7-4
2. Initial Settings	7-5
User Settings on the Control Panel	7-5
User Mode	7-6
Entering and Leaving the User Mode	7-7
Settings in Each User Mode Function	7-8
System Settings by the dealer	7-12
For Key Operator's Use	7-15

Chapter 1

Safety Notes

This chapter provides precautions for use, a description of the operating environment and conditions as well as instructions on how to turn the system ON and OFF.

1. Installation Precautions

Installation Site

Placement of the unit in the environment described below will ensure optimal performance throughout the long life of service for which it was designed.

- ◆ A well-ventilated place.
- ◆ An area which is free from ammonia or other organic gases.
- ◆ A place which has easy access to a power outlet so that the unit may be easily plugged in and unplugged.
- ◆ Any area free from direct sunlight.
- ◆ A place which is out of the direct air stream of an air conditioner, heater or ventilator and is not subject to extremely high or low temperatures or humidity.
- ◆ A stable location with a flat surface that is not subject to undue vibration.
- ◆ A place that is free from any object that would block the heat exhaust duct of the printer.
- ◆ A place away from curtains or anything else that is easily flammable.
- ◆ An area that is safe from spilled water or other liquids.
- ◆ A dust-free location.

NOTE

If the Scanner is to be located near a window, do not face the Screen towards the window.

Power Source

The power source voltage requirements are as follows:

- ◆ Use a power source with minimal voltage fluctuation.

Power Source:	50Hz-60Hz
Voltage fluctuation:	within $\pm 10\%$
Frequently fluctuation:	within $\pm 3\%$
- ◆ Be careful not to exceed the capacity of the outlet, especially when sourcing other appliances from the same outlet.
- ◆ The outlet should be located near the unit and be easily accessible so that the power cord can be unplugged immediately if necessary.
- ◆ NEVER connect any other appliances or machines by means of a multiple socket to the outlet being used for the unit.
- ◆ If an extension cord is needed, use one with a capacity greater than the power consumption of the unit.
- ◆ Make sure that the power cord and extension cord do not become caught in any mechanism of the system. Do not allow either the power or extension cord to become caught underneath the weight of the unit.

Grounding

To prevent electrical shocks caused by electrical leakage, always ground the printer.

- ◆ Connect the grounding wire to:
 - The ground terminal of the outlet.
 - A grounding contact that complies with the local electrical standards.
- ◆ NEVER connect the grounding wire to a gas pipe, the grounding wire for a telephone, or a water pipe.

Space Requirements

Scanner

There should be a clearance of the following dimensions between the wall and the rear of the unit as well as its right and left sides to provide ample space for the ventilation ports to dissipate heat.

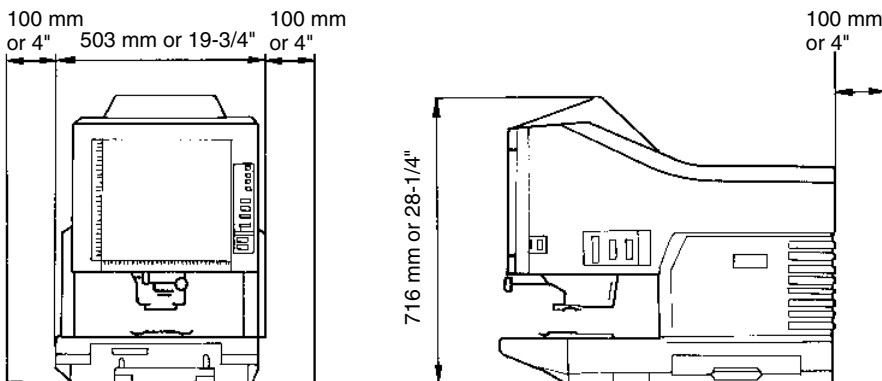

1. Installation Precautions

Printer

MSP 3500 Printer:

For ease of operation, maintenance and replenishment of supplies, the minimum clearance diagrammed below is required. Install the unit in an area that allows easy access.

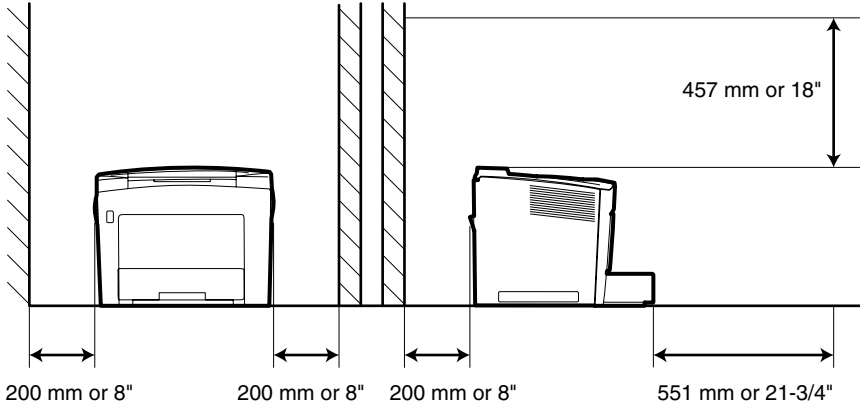

MSP 3000 Printer:

For ease of operation, maintenance and replenishment of supplies, the minimum clearance diagrammed below is required. Install the unit in an area that allows easy access.

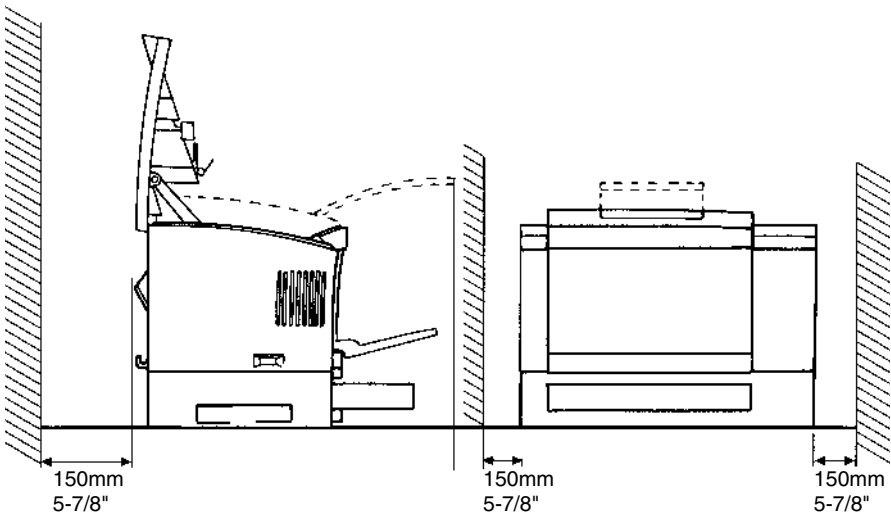

Operating Environment

The environmental requirements for operating the system are as follows:

Temperature: 10 °C to 35 °C (50 °F to 95 °F) with a fluctuation of 10 °C (18°F) per hour.
Humidity: 15% to 85% with a fluctuation of 20% per hour.

Using the Printer

To ensure the optimum performance of the printer, follow the precautions listed below:

- ◆ NEVER open any Cover, or turn OFF the printer during printing.
- ◆ NEVER bring any magnetized object or flammable gas or liquid close to the printer.
- ◆ ALWAYS insert the Power Plug all the way into the outlet.
- ◆ ALWAYS provide good ventilation when making a large number of continuous prints.

NOTE

= Locate the Printer in a Well Ventilated Room =

A minimal amount of ozone is generated during normal operation of the printer. An unpleasant odor may, however, be created in poorly ventilated rooms during extensive printer operations.

For a comfortable, healthy, and safe operating environment, it is recommended that the room be well ventilated.

Care of Printer Supplies

Use the following precautions when handling the printer supplies (Imaging Cartridge, paper, etc.).

- ◆ Avoid storing the supplies in any of the following places:
 - A place subject to direct sunlight. The Imaging Cartridge should not be exposed to fluorescent light, either.
 - A hot place or near an open flame.
 - A humid place.
 - A dusty place.
- ◆ Store paper, which has been removed from its wrapper but not loaded onto the print tray, in a sealed plastic bag in a cool, dark place.
- ◆ Only use Imaging Cartridges that are exclusively designed for use with this printer.
- ◆ Keep supplies out of the reach of children.
- ◆ If your hands become soiled with toner, wash them with soap and water immediately.

NOTE

Whenever the Imaging Cartridge is removed from the printer, immediately wrap it in a heavy cloth to protect it from light.

2. Turning the Power On and Off

Turning ON

- 1** Press the Power Switch of the scanner to the I (ON) position.

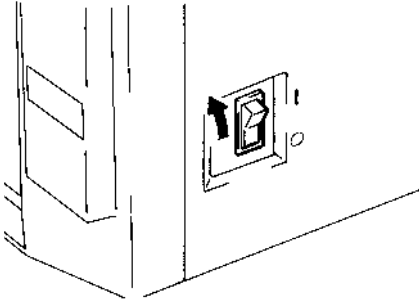

- 2** Press the Power Switch of the printer to the I (ON) position.

- 3** The Control Panel displays a blinking "1" and the unit starts to warm up. The unit is ready to read data when the "1" stops blinking.

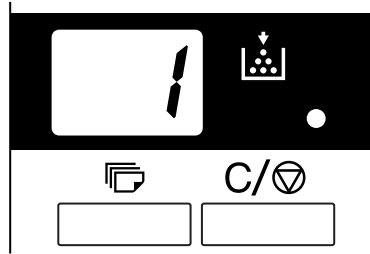

Useful Tips

If you load the film in the film carrier and press the start button while the printer is warming up, you can scan and memorize the film image of about 9 pages (Letter or A4 size/400dpi) into this system. And then, printer allows that print process to be started as soon as the printer completes warming up. At this time, both ends of Exposure Display blink.

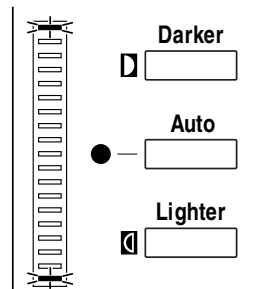

If you want to disable this function, ask your authorized Technical Representative to make change the system setting.

Turning OFF

- 1 Press the Power Switch of the scanner to the O (OFF) position.

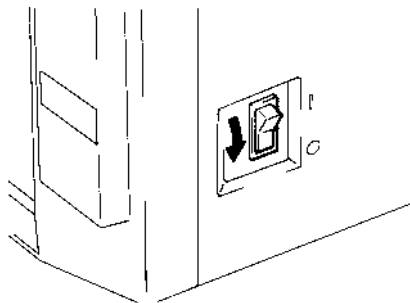

- 2 Press the Power Switch of the printer to the O (OFF) position.

NOTE

The printer and scanner can be turned ON and OFF at the same time by employing a cord that is equipped with an on/off switch saving both time and energy.

**Make sure that all cords used comply with the specified ratings of the unit.*

3. Auto Power Save Mode

The unit enters the Auto Power Save mode if it is left to stand idle for a predetermined period of time. When the unit enters the Auto Power Save mode, power to the Scanner projection lamp and the printer heater is automatically shut down to save power consumption.

A User Mode function is available that allows the user to set the time it takes the unit to enter the Auto Power Save mode. The setting options are as follows:

- Auto Power Save (15 min.)
- Auto Power Save (30 min.)
- Auto Power Save (60 min.)

NOTE

The Auto Power Save Mode can also be disabled. Ask the authorized Technical Representative if you want to disable this function.

Segments of the Multi-Print Display light up and go out sequentially in the clockwise direction when the unit is in the Auto Power Save mode.

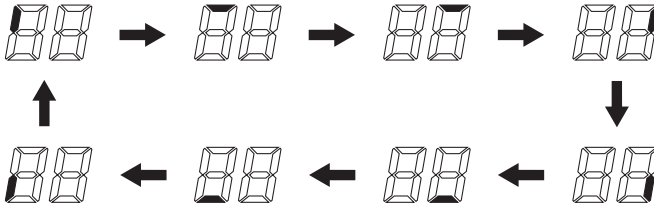

To let the unit leave the Auto Power Save mode, press any key on the control panel. At this time, the Scanner projection lamp lights up steadily and the printer is set into the warm-up condition.

NOTE

For the USA and Canada only:

The Auto Power Save function becomes available for setting only if the Energy Miser kit is mounted on the Scanner.

Chapter 2

Scanner

This chapter identifies different parts of the Scanner and explains its operation.

1. System Overview

Scanner

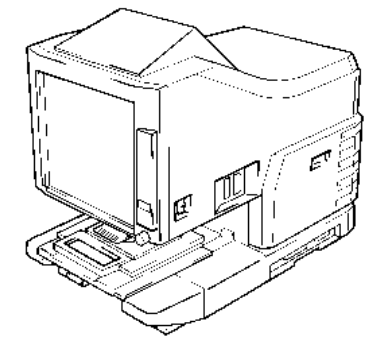

Projection Lenses

Single Lens

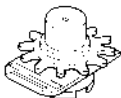

7.5x
Zoom Lens



9-16x



13-27x



23-50x

- Prism Unit
- Manual Frame
- Masking Kit
- Foot Switch Kit
- Counter Kit
- USB I/F Kit

Film Carriers

FC-5



RFC-15A

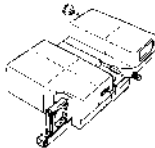

UC-2

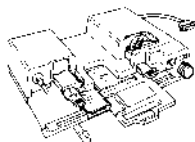

RFC-15M

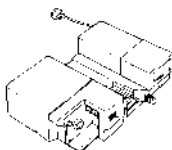

Controllers

MARS MINI CONTROLLER 2



System Configuration

This Scanner is available in the following configurations.

PR Mode (connected to a printer)

The Scanner is connected to a dedicated printer (MSP 3500 or MSP 3000), allowing scanned images to be printed out directly.

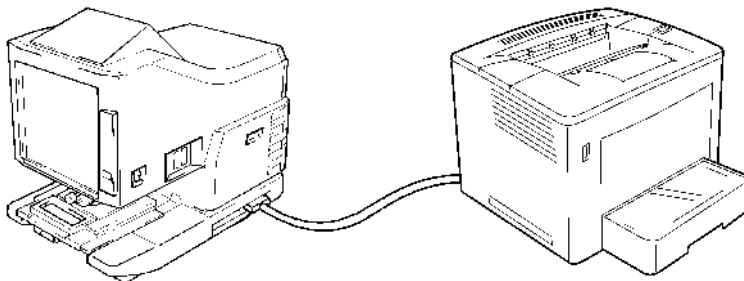

PC Mode (connected to a personal computer)

The Scanner is connected to a personal computer and the scanned images can be uploaded to the computer. An optional USB interface kit required for connection to a personal computer. Contact the authorized dealer for details.

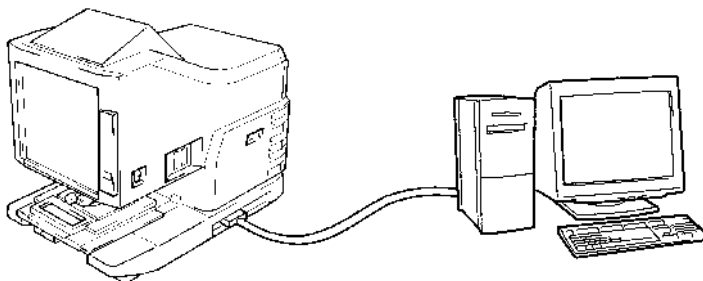

Connection to a personal computer and printer can be switched using Control Panel. Refer to “Selecting the Connection Mode” on p. 2-36.

2. Parts of the Scanner

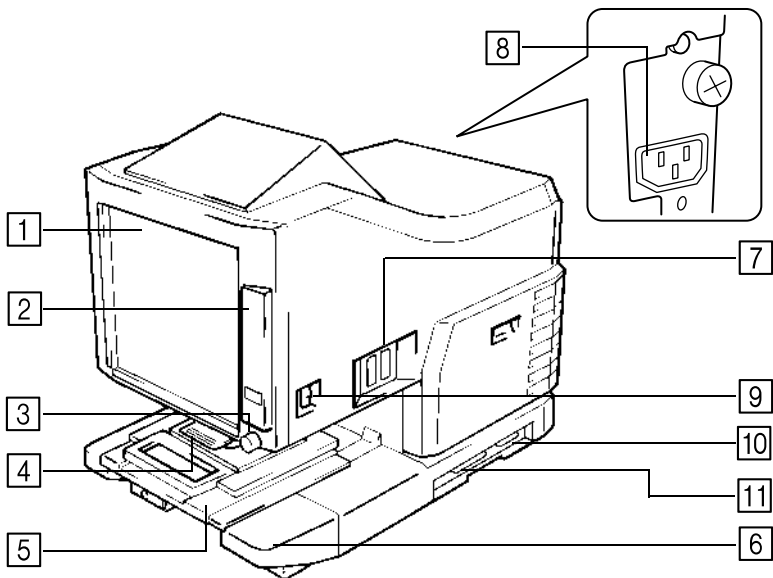

- | | | |
|-----------|------------------------------------|--|
| 1 | Screen: | The image taken from the film is projected here for viewing. The frame on the Screen marks the data reading range. |
| 2 | Control Panel: | Many operations are controlled from the keys and indicators provided here. |
| 3 | Image Rotation Knob: | Used to turn the Prism Unit built into the Scanner, turning the image on the Screen. |
| 4 | Projection Lens (Optional): | Used to change the size and adjust the focus of the image on the Screen. |
| 5 | Fiche Carrier 5 (Optional): | Supports the viewing of microfiche. |
| 6 | Projection Lamp Unit: | Contains are Mirror and Lens which projects the film image onto the Screen. |
| 7 | Connectors: | Provides connection points for the various options (Roll Film Carrier and Controller). |
| 8 | Power Cord Socket: | Plug the power cord furnished with the Scanner into this socket. |
| 9 | Power Switch: | Used to turn power to the unit ON and OFF. |
| 10 | Printer Connector: | Connects the scanner to the printer through an interface cable. |
| 11 | USB Connector (Optional): | Connects the scanner to the Personal Computer through a USB cable. |

3. Control Panel Keys and Indicators

Control Panel (Basic)

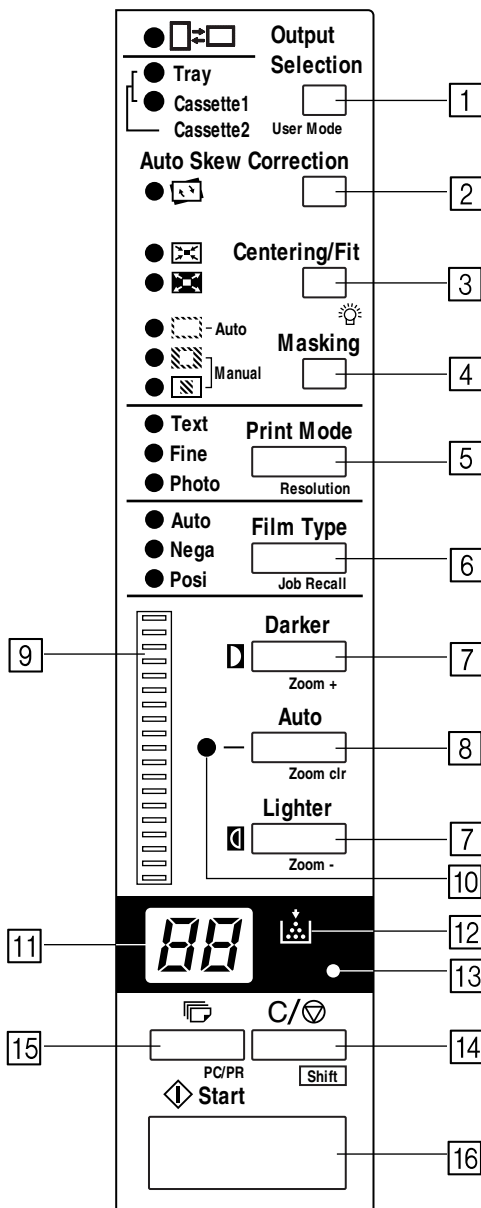

3. Control Panel Keys and Indicators

1 Output Selection Key: Select the paper feeding source according to the format of the film image that is being reflected in the screen.

* This key is only available on the PR mode.

: when this lamp is lit:
A 90 degree image rotation is performed during printing.
The image on the screen will be rotated 90 degrees. Consequently, the screen image will be oriented horizontally on paper that is positioned lengthwise, and vertically on paper that is positioned crosswise.

when this lamp is blink:
The Auto Film Format Select Print function is available when Letter (or A4) size paper is placed in both lengthwise and crosswise positions in the paper feeding tray and paper feeding cassette. Paper that best suits the format of the image on the screen will be used for printing.
If you would like to use this function, please contact the authorized dealer.

Tray: Prints the film image on paper fed from the print tray.

Cassette1: Prints the film image on paper fed from the cassette 1.

Cassette2: Prints the film image on paper fed from the cassette 2. (when the Tray and Cassette1 indicators are both lit)

2 Auto Skew Correction Key: This key is used to turn the Auto Skew Correction function ON or OFF. When this function is applied, the Auto Skew Correction indicator will turn on and the system will correct any skew of the image during printing.

* After printing, the skew can be reset or retained. Contact the authorized dealer for more information.

3. Control Panel Keys and Indicators

3 Centering/Fit Key:

When this key is pressed, the setting rotates from OFF to the Centering and Fit functions.

When Auto Masking, Trimming, or Masking are set to off, Auto Masking will automatically be enabled when Centering is selected.



Centering:

Places a screen image that had been searched using Auto masking or an image that has been trimmed in the center of the page.



Fit:

Enlarges a screen image that had been searched using Auto masking or an image that has been trimmed to fit the page.

* When Masking  is selected or when the Scanner is connected to the PC, this mode cannot be used.

3. Control Panel Keys and Indicators

4 Masking Key:

When pressed, this key rotates from OFF to the Auto, Trimming or Masking functions.

Each time this key is pressed, selection is switched in order of “OFF → Auto Masking → Manual Trimming → Manual Masking → OFF.”

 Auto Masking:

The Auto Masking function will omit the frame (non-image area) of a printed film image.

- The previous Centering/Fit setting is applied whenever ON is selected from the OFF state.
- If OFF is selected from the ON state, Centering/Fit is disabled.
- * Auto Masking is not applicable with the Masking or Trimming settings.

 Trimming:

When ON is selected, the image is printed (scanned) with the non-image area (frame) automatically masked.

 Masking:

Prints only the image outside of the area that is defined on the Screen.

- If Trimming is selected from the OFF state, the previously entered settings for Centering/Fit and Manual Masking are applied.
- From Trimming, when Masking is selected, the Centering/Fit setting is disabled and the previous settings for the Masking area are applied.
- The manual masking area will be cancelled whenever OFF is selected from the Masking state.
- * Neither Trimming nor Masking are available through the Auto Masking function.
- * Trimming and Masking cannot be set when the Scanner is connected to the PC.

5 Print Mode Key:

Allows you to fine tune the image quality of the print according to the original being used. Rotate between Text, Fine and Photo with every press of this key.

- 1) Text: For use with text images.
- 2) Fine: For use with lower grades of film.
- 3) Photo: For use with photo images.

3. Control Panel Keys and Indicators

- 6 Film Type Key:** Rotates between Auto, Nega, and Posi each time the key is pressed.
- 1) Auto: The scanner automatically determines between the film type options of negative or positive for print production.
 - 2) Nega: Select when using negative film. Dark and light values of the print will be reversed.
 - 3) Posi: Select when using positive film. Dark and light values of the print will be consistent with the image on film.
- 7 Exposure Adjustment Keys:** Use this key to adjust the image density of the image to be printed during the Auto or Manual Exposure mode. The Darker key supports darker image density and the Lighter key supports lighter image density.
- 8 Exposure Mode Key:** Press to select between the Auto or Manual Exposure mode.
- 9 Exposure Display:** Indicates the current density level of the printed image.
- 10 Exposure Mode Indicator:** Auto Exposure mode is indicated when the green Auto light is on. The green Auto light turns off when the Scanner is in the Manual Exposure mode.
- 11 Multi-Print Display:** Shows the number of prints set to be made. Also displays corresponding codes in the event of a malfunction or paper misfeed. The blinking number in this display indicates the Scanner in operation.
- 12 Add Toner Indicator:** Blinks when the Imaging Cartridge or Toner Cartridge of the Printer is running out of toner and lights up when the cartridge has completely run out of toner.
* PR mode only.

3. Control Panel Keys and Indicators

13 Memory Input Key: To store one of the following functions into the memory of the Scanner, first set one of the functions on Control Panel and then press this button with the head of a pen or other device. The next time the scanner is turned ON, that function will appear as a default setting until a new one is entered. (Maximum three kind of setting can be memorized.)

- 1) Negative or positive
- 2) Print mode
- 3) Output Format
- 4) Print image density
- 5) Exposure mode
- 6) Centering or Fit
- 7) Masking
- 8) Auto Skew Correction
- 9) Horizontal Area setting
- 10) Vertical Area setting
- 11) Electrical Zoom
- 12) Resolution
- 13) Image Distortion Correction

NOTE

If you do not press the pinhole for at least 60 seconds after a setting has been made with the Auto Reset function set to ON, the previous setting remains valid.

14 Clear/Stop Key: Press to clear the setting on the Multi-Print Display, resetting it to “1” or to stop a multi-print cycle.

15 Multi-Print Keys: This key is used to set the number of prints when printing continuous, multiple pages.

The value of this setting increases by one (1, 2, 3...) with every push of the key. (Maximum 19)

* PR mode only.

16 Start Key: Press to make a print (scan) of the image shown on the Screen.

Control Panel (Shift Function)

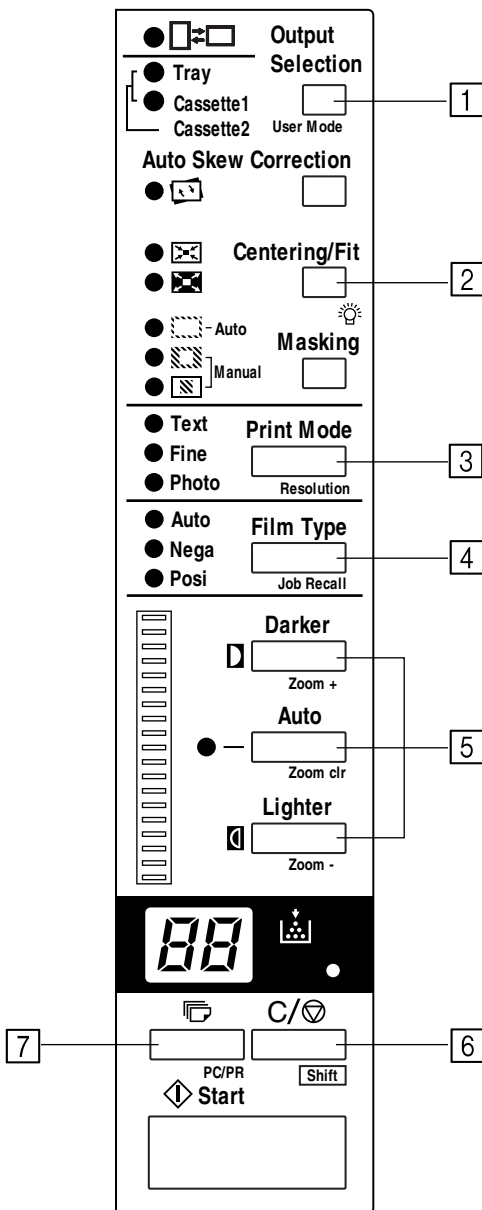

3. Control Panel Keys and Indicators

- 1 User Mode Key:** Pressing this key together with the Shift Key enters the unit into the User Mode.  See p. 7-6 User Mode.
- 2 Lamp Illuminance Key:** When this key is pressed together with the Shift Key, the illumination of the screen is adjusted. When this key is continuously pressed, the screen is gradually darkened until it is turned OFF. When any key is pressed then, the illumination returns to the maximum level.
- 3 Resolution Key:** When this key is pressed together with the Shift Key, the resolution of the Scanner is set.
 When the Scanner is connected to the MSP 3500 Printer: 6H
 When the Scanner is connected to the MSP 3000 Printer: 4H and 6H
 When the Scanner is connected to the PC: 2H, 3H, 4H, 6H and 8H
 * 4H represents 400dpi and 6H represents 600dpi.
- 4 Job Recall Key:** When this key is pressed together with the Shift Key, the program registration locations (1J, 2J and 3J) are called. Each time this key is pressed while the Shift Key is held down, the display is switched in order of 1J → 2J → 3J.
- 5 Zoom Key:** When this key is pressed together with the Shift Key, the electrical zoom magnification is set.
 Zoom+: When this key is pressed together with the Shift Key, the magnification is increased by an increment of 0.01X (up to 2.00X).
 Zoom clr: When this key is held down together with the Shift Key for one second, the standard magnification is resumed.
 Zoom-: When this key is pressed together with the Shift Key, the magnification is decreased by a decrement of 0.01X (down to 0.50X).
- 6 Shift Key:** Executes an expansion function when being pressed together with the intended function key.
- 7 PC/PR Key:** When this key is pressed together with the Shift Key, the connection to the PC or to the Printer is selected.
 * This key is not valid unless the USB interface kit (optional) is installed.

When (Misfeed/Call-Tech.-Rep. Code) Lights up

This indicates that a paper misfeed or malfunction has occurred in the system. Check the code shown on the Multi-Print Display and perform the misfeed clearing procedure or the Call-Tech.-Rep. procedure.

Malfunxions Procedure

* Only MSP3500 displays the code.

Code	Description
<i>E 1</i>	The power to the printer is OFF or there is a problem with the connection of the interface cable to the printer. Turn ON the printer or make sure that the interface cable is securely connected.
<i>E 2</i>	The upper cover of the printer is not closed. Make sure that it is completely closed.
<i>E 3</i> *	It is defective of the toner cartridge. Or, the toner cartridge is not installed. Install a correct toner cartridge.
<i>E 4</i> *	The toner cartridge of a different type is set. Install a correct toner cartridge.
<i>FE</i> *	You are using an end-of-lifed (completely used) toner cartridge(s). When Start Key is pushed again, it prints. (When Clear/Stop Key is pushed, the print is canceled.) To ensure the best print quality, you are strongly recommended to replace immediately.
<i>PE</i>	The printer is out of paper. Load some paper into the paper cassette.  See p. 3-6, p. 4-6.
<i>PF</i> *	Paper of the output bin was filled. Remove the paper from the output bin.

3. Control Panel Keys and Indicators

Code	Description
<i>PC</i>	The Scanner is connected to the PC and ready for scanning by pressing the Start Key. This display is blinking when the Scanner is in operation.
<i>Pc</i>	The Scanner is not connected to the PC. Turn ON the PC or connect the Scanner to the PC with the interface cable.
<i>L2</i>	The Projection Lamp is burned out. Replace the lamp. ☞ See p. 2-43. * If the lamp goes out during a print cycle, a blank print may be output.
<i>Lb</i>	The battery for Date Print has run down. Turn OFF the Date Print function, or call your Tech. Rep. for replacement of the battery.
<i>01</i>	Magnification warning display Did the modification of the magnification by an electronic zoom. Lights up when setting besides the standard magnification.

3. Control Panel Keys and Indicators

Misfeed Clearing Procedure

Locate the misfeed using the code and perform the misfeed clearing procedure.

Code	Description
<i>P0</i>	The wrong size paper has been loaded in the Paper Feeding Tray. Load the set size paper in the set direction. This code also appears when two or more sheets of paper are taken up at the same time.
<i>P1</i>	A misfeed near the paper take-up section or more sheets of paper are taken up at the same time.
<i>P2</i>	A misfeed near the Toner Cartridge.
<i>P3</i>	A misfeed near the Fusing Unit.
<i>J0</i>	An aperture card misfeed has occurred in ACF-7. Remove the card that has been misfed in ACF-7.

3. Control Panel Keys and Indicators

Call-Tech.-Rep. Procedure

A malfunction has occurred in the system.

* Only MSP3500 displays the code.

Location	Code	Description
Scanner	C1	Optical path switching failure
	C2	A Scanning malfunction
	C4	A Fan Motor malfunction
Printer	C6	A Fusing Unit malfunction
	C7	An Laser malfunction
	C8	A Polygon Motor malfunction
	C9	A Main Drive Motor malfunction An Imaging cartridge drive motor malfunction
	CA	A Fan Motor malfunction
	CC *	An Image transfer voltage error
Scanner Printer	Cb	A Communication malfunction (Printer)
	CL	A Printer Clock malfunction
Scanner PC	Cc	A Communication malfunction (PC)
	Cd	A Communication malfunction (ACF-7)

NOTE

After turning the power to the system OFF and unplugging its power cord from the electrical outlet, contact the authorized dealer, being sure to provide him or her with the currently displayed code (Above code).

4. Image Processing Functions

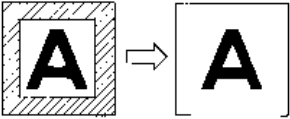
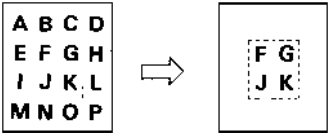
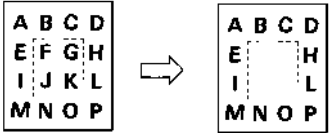
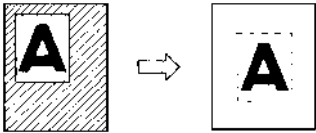
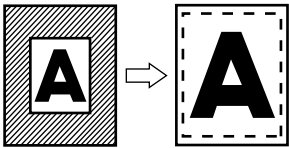
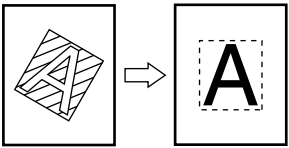
Screen Image → Print Image	Description
<p>Auto Masking (1 Frame)</p> 	<p>The system masks the black bands that run along the edges of the image.</p>
<p>Trimming (1 Frame)</p> 	<p>The system masks everything but the center of the image. * The Manual Frame Masking Kit (option) is required.</p>
<p>Masking (1 Frame)</p> 	<p>The system masks the center of the image appearing on the screen through the Manual Frame Masking Panel function. * The Manual Frame Masking Kit (option) is required.</p>
<p>Auto Centering</p> 	<p>The system generates an image that is centered on the printed page, from an image on the screen with a masked frame.</p>
<p>Fit</p> 	<p>Fit the image on the Screen onto the entire surface of the print.</p>
<p>Auto Skew Correction</p> 	<p>The unit automatically correct any skew of the image when printed.</p>

4. Image Processing Functions

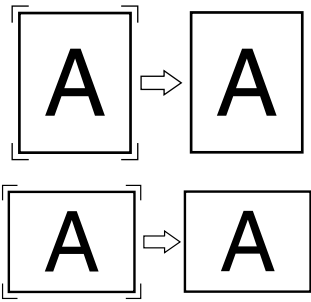
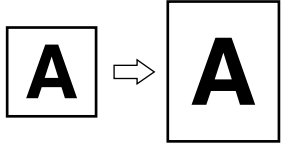
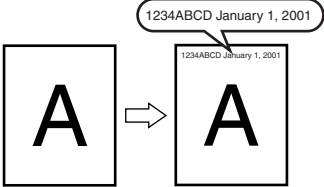
Screen Image → Print Image	Description
<p>Auto Film Format Select Print</p> 	<p>The unit automatically determines the format (portrait or landscape) of the image on the Screen and prints it as necessary. If you would like to use this function, please contact the authorized Technical Representative.</p>
<p>Image Zoom</p> 	<p>The system magnifies the screen image according to the size of paper being used. The range of magnification is 1.55x for Ledger, 1.27x for Legal, 1.41x for A3 and 1.22x for B4 sized paper.</p>
<p>Overlay</p> 	<p>Time, date, and messages can be included on print-out. If you would like to use this function, please contact the authorized Technical Representative.</p>

5. Printing/Scanning

Here is an outline of the printing procedure:

1. Load the film

The procedure for loading film is determined by the type of Film Carrier (optional) that is being used. Review the Operator's Manual that came with your Film Carrier for more information.

2. Select and replace the Lens See p. 2-20, p. 2-21.

Select the appropriate lens for the type of film being used and install it in the Scanner.

3. Select the Connection Mode See p. 2-36.

Select either PC connection mode or PR connection mode.

4. Zooming, focusing and image rotation See p. 2-21, p. 2-23.

Use the Zooming Ring Dial to frame a desired range of the image on the screen for printing.

Use the Focus Ring Dial to sharpen the clarity of the image on the screen.

Use the Image Rotation Knob to orient the image on the screen.

* Press the Auto Skew Correction key to have the skew of the image automatically corrected.

5. Select either negative or positive printing See p. 2-23.

Select between negative or positive printing according to the type of film that is being used.

6. Select the image density See p. 2-24.

Use Auto Exposure to automatically determine the optimum image density for the application.

The image density can also be set manually by using the Exposure Adjustment keys (Darker or Lighter).

7. Enter the number of prints to be made See p. 2-26.

Using the Multi-Print keys, enter the number of prints to be made.

8. Selecting the Output Format See p. 2-27.

Using the Output selection key, set the paper source and print format setting.

9. If required, adjust the image processing functions.

Auto Masking  See p. 2-29.



Manual Masking (Masking or Trimming)  See p. 2-31.

Image Centering or Fit  See p. 2-33.

10. Press the Start key.

 **Start**

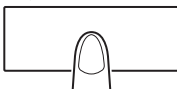

The printing or scanning of the image appearing on the screen is initiated after the Start key is pressed.

6. Selecting a Projection Lens

Projection Lenses come in the following four types. Select the one that corresponds to the film being used.

- Projection Lens Types
- 1 Type 1: 7.5×
 - 2 Type 1: 9 to 16×
 - 3 Type 2: 13 to 27×
 - 4 Type 3: 23 to 50×

Film		Scanning Size
		8-1/2"×11" (A4)
35mm	Half	<input type="checkbox"/> 2
	Full	<input type="checkbox"/> 1
16mm	Half	<input type="checkbox"/> 3
	Full	<input type="checkbox"/> 2
Source Document	60	<input type="checkbox"/> 3
	98	<input type="checkbox"/> 3 or <input type="checkbox"/> 4
	325	<input type="checkbox"/> 4
	420	<input type="checkbox"/> 4
COM	63	<input type="checkbox"/> 3
	70	<input type="checkbox"/> 3
	80	<input type="checkbox"/> 3 or <input type="checkbox"/> 4
	84	<input type="checkbox"/> 3 or <input type="checkbox"/> 4
	120	<input type="checkbox"/> 3 or <input type="checkbox"/> 4
	208	<input type="checkbox"/> 4
	270	<input type="checkbox"/> 4

This list shows the standard types of film and the recommended zoom ratios of lenses to be used with the unit. The size and format of one frame of film may vary depending on the shooting conditions.

Zoom the lens in and out to find the optimum ratio that will fit the scanning size.

7. Replacing the Projection Lens

To install a Lens with a magnification different from that already installed in the unit, follow the procedure given below.

- 1 Take hold of the Prism Holder Lever and pull it up to raise the Prism Holder.

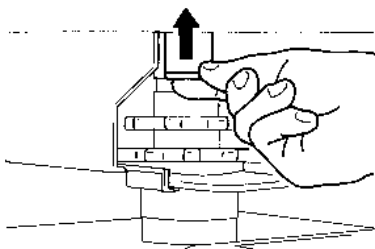

- 2 Pull out the Lens Unit.

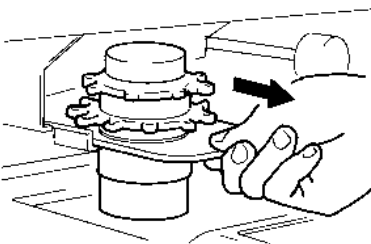

- 3 Slide the Lens Unit into position along the Lens Guide.

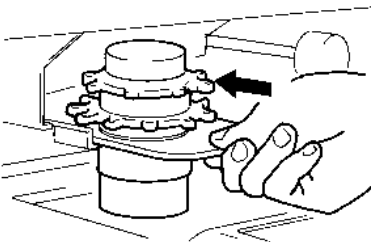

- 4 Pull out the Brightness Select Lever and slide it to a position appropriate for the type of the Projection Lens loaded in the unit.
The lever should click into position.

NOTE

Brightness on the Screen is uneven if the Brightness Select Lever is not placed in a position corresponding to the type of the Projection Lens being used. Be sure to place the Lever into the correct position according to the type of Projection Lens.

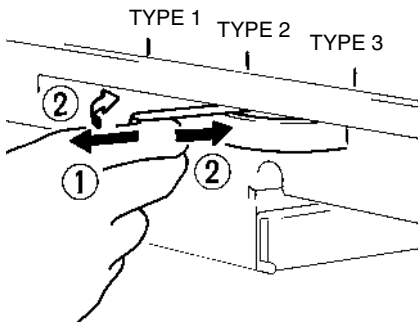

8. Zooming and Focusing

Zooming of the Screen Image

- 1 Rotate the Zooming Ring Dial to bring the image on the Screen into print size frame.

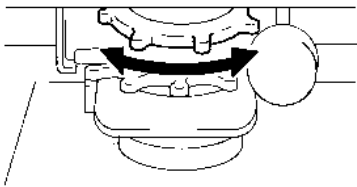

Focusing of the Screen Image

- Rotate the Focusing Ring Dial to bring the image on the Screen into focus.

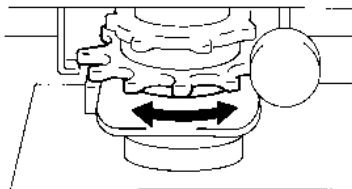

- 2 Marked on the Screen are the size frame markers corresponding to the paper size (8-1/2" × 11" or A4). Zoom the film image so that it fits inside the markers.

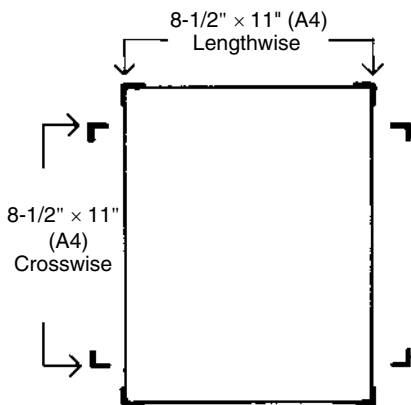

9. Image Rotation

To turn the image on the Screen, turn the Image Rotation Knob.

Auto Image Rotation:

Turn the Image Rotation Knob on the bottom right of the Screen Frame to turn the image.

The greater the turning angle of the Image Rotation Knob, the faster the turning speed.



When the Image Rotation Knob is turned while holding down the Shift Key, the image quickly rotates by 90°.

Auto Skew Correction

If the Auto Skew Correction Key is turned ON, the system will automatically correct any skew of the image when printed.



NOTE

This function supports angle rotations of up to 30°.

10. Selecting the Film Type

Auto

1 The system will automatically determine the polarity of the film being used when Auto is selected with the Film Type key.

Nega/Posi

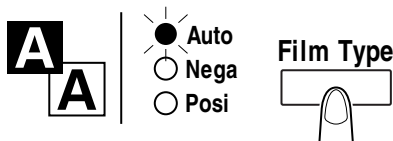

Posi (positive film)

1 If positive film is to be used, press the Film Type Key to select Posi.

Posi



NOTE

- The system cannot determine the polarity of certain types of film. Should this occur, the film type should be selected manually.
- The system does not detect exterior conditions such as when the glass surface of the Carrier is dirty or scratched.

Nega (negative film)

1 If negative film is to be used, press the Film Type Key to select Nega.

Nega



11. Selecting the Image Density

Using Auto Exposure

- 1** Depress the Exposure Mode Select Button as necessary to select the Auto Exposure Mode.
The LED to the left of the key lights up green when the Auto Exposure mode is selected.

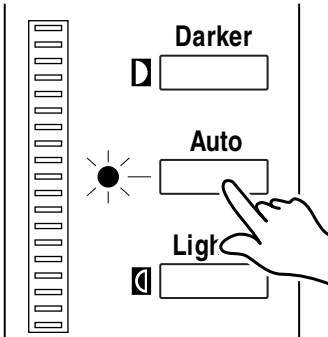

- 2** Depress the appropriate Exposure Adjustment Button, either LIGHTER or DARKER, to set the desired image density, or exposure, level.

Depress LIGHTER to make the image lighter.

Depress DARKER to make the image darker.

When the LIGHTER and DARKER keys are depressed at once, the exposure level comes at the center.

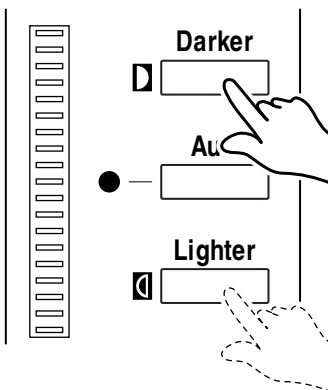

Using Manual Exposure

- 1** Depress the Exposure Mode Select Button as necessary to select the Manual Exposure mode.
The LED to the left of the key lights down green when the Auto Exposure mode is selected.

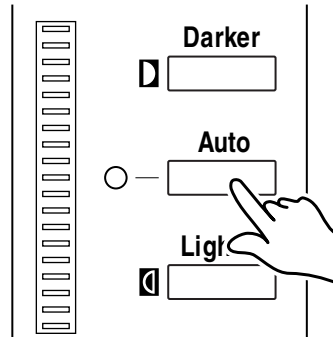

- 2** Depress the appropriate Exposure Adjustment Button, either LIGHTER or DARKER, to set the desired image density, or exposure, level.

Depress LIGHTER to make the image lighter.

Depress DARKER to make the image darker.

When the LIGHTER and DARKER keys are depressed at once, the exposure level comes at the center.

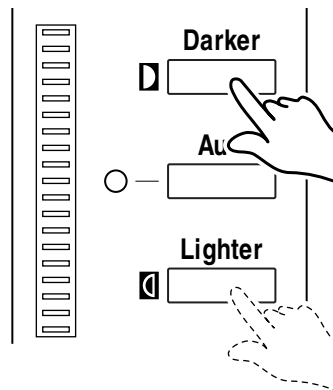

12. Setting the Number of Prints to be Made

To Entry the Number of Prints

Set the desired number using the Multi-Print Key.

NOTE

This function is only available on the PR mode.

The number that can be entered is 19 max.

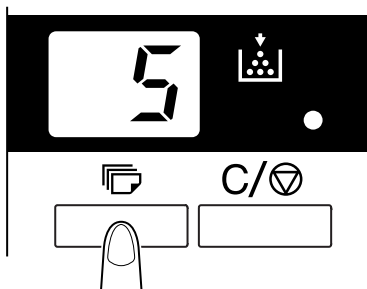

Correcting Entry

To correct an entry, depress the Clean Button, which resets the number on the Multi-Print Display to "1".

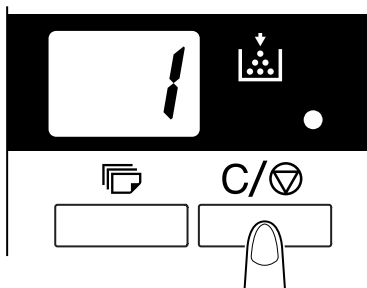

13. Selecting the Output Format

Press the Output Selection Key to select the paper source and print format.

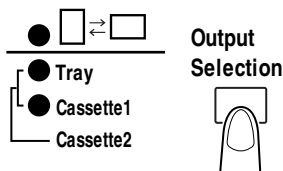

Selecting the paper source

Tray: Prints the film image on paper from the print tray.

Cassette 1: Prints the film image on paper from the cassette 1.

Cassette 2: Prints the film image on paper from the cassette 2.
(When the Tray and Cassette 1 indicators are both lit.)

The standard magnification is fixed according to the selected size of the paper from the paper feeder.

Paper size	A3	B4	A4	B5	Ledger	Legal	Letter
Standard magnification	1.41x	1.22x	1.00x	1.00x	1.55x	1.27x	1.00x

For A3, B4, Ledger and Legal, zoom is made by the above standard magnification and printed within the on-screen range 8-1/2" x 11" (A4).

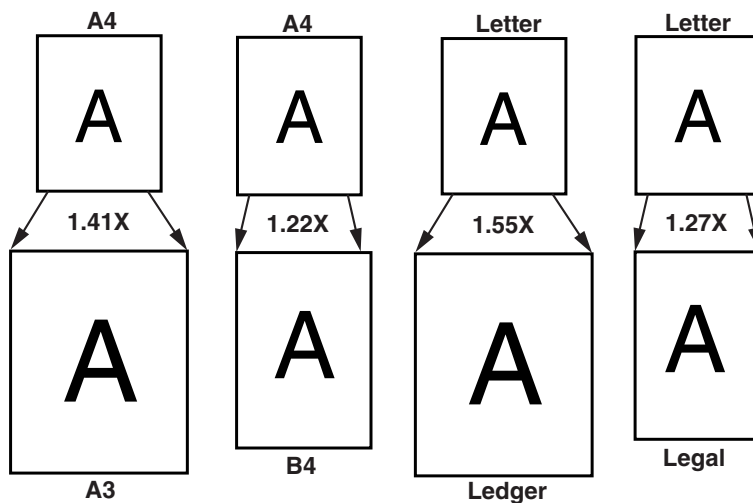

13. Selecting the Output Format

Selecting the print format

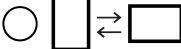
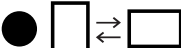
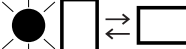
Display	Paper Feeding	Description
Light OFF 	Lengthwise	Prints the on-screen lengthwise area.
	Crosswise	Prints the on-screen crosswise area.
Light ON 	Lengthwise	Prints the on-screen crosswise area.
	Crosswise	Prints the on-screen lengthwise area.
Blinking 	Lengthwise	Prints the on-screen image by automatically judging whether it is lengthwise or crosswise.
	Crosswise	

14. Using Auto Masking

The Auto Masking function prevents the frame (non-image area) of a film image from appearing on the print.

Selecting Auto Masking

1 Press the Auto Masking key to turn ON this function.

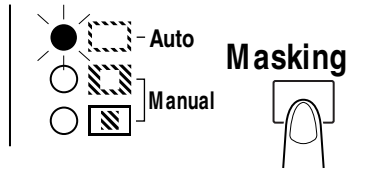

Operating Conditions for Auto Masking

- A. The image area of the screen must provide at least 45mm horizontally and vertically.
- B. The width of the frame to be masked must be at least 10mm.

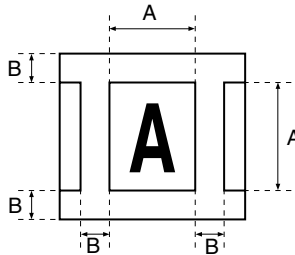

NOTE

If the film image on the screen does not meet the above requirements, the Auto Masking function will not work properly.

Auto Masking is a frame erasing feature. It cannot remove an image from in between two separate frames.

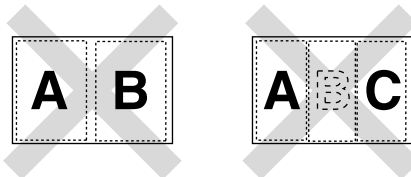

15. Manual Masking Panels (Optional)

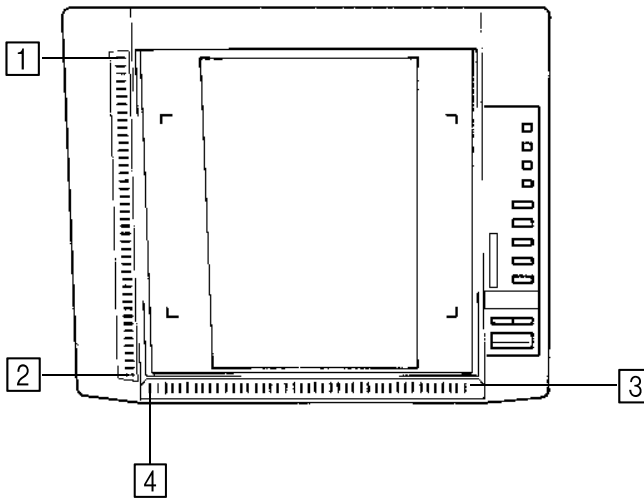

- 1 Vertical Area Indication Panel:** Use to specify the vertical print (scan) area of the image on the screen. There are 42 lights placed at 7mm intervals. The lights create a pattern when lit specifying the area on the screen that will be printed.
- 2 Vertical Area Clear Key:** Press to clear a previously specified vertical print (scan) area.
- 3 Horizontal Area Indication Panel:** Use to specify the horizontal print (scan) area of the image on the screen. There are 42 lights placed at 7mm intervals. The lights create a pattern when lit specifying the area on the screen that will be printed.
- 4 Horizontal Area Clear Key:** Press to clear a previously specified horizontal print (scan) area.

16. Using Manual Masking

The optional Manual Frame Masking Kit allows you to specify an area for printing of the displayed image through two separate features, Trimming and Masking.

NOTE

Under the PC mode, the print (scan) area can be defined using the Manual Masking Panels.

The Trimming and Masking functions cannot be used in the PC mode.

Selecting Trimming

- 1 Press the (manual) Masking key to select  (Trimming).

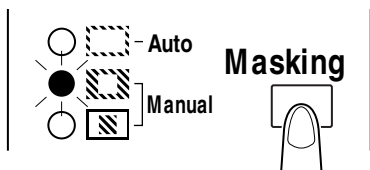

- 2 The lights on the panel light up according to the currently selected paper size and print position.

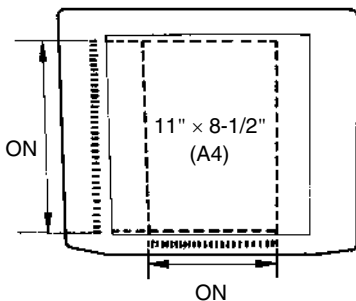

NOTE

It is possible to print the area specified by the green lights.

The lights which do not accord with the selected paper size and the print position may light up just after the Job Program is called up.

Defining the Print Area

- 1 Define the end points for both the vertical and horizontal areas of the image on the screen using the green lights on the area indication panels.

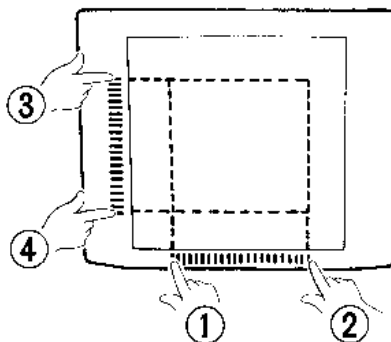

NOTE

The points defining the vertical and horizontal area can be selected in any order.

Blinking lights on the indication panels indicate an improper entry of the specified area. Specify the area again.

16. Using Manual Masking

Clearing a Defined Print (Scan) Area

- 1** Press the Vertical and Horizontal Area Clear keys to clear the defined print (scan) area.
- 1: Horizontal Area Clear Key
 - 2: Vertical Area Clear Key

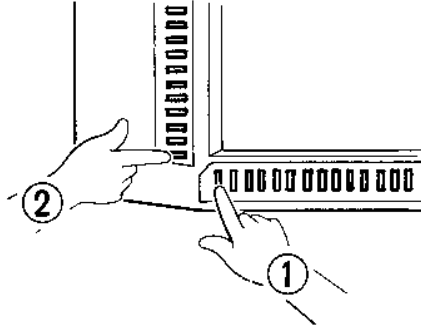



Selecting Masking

Press the (manual) Masking key to select  (Masking) when you want to mask a given area of the image.

The basic operation for manual Masking is similar to Trimming. Please refer to the previous procedures on Trimming and defining areas for instructions on performing manual Masking.

17. Using Centering and Fit

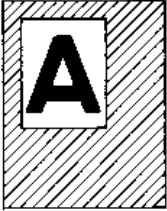
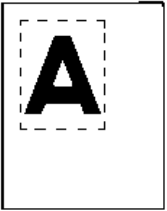
Once the image on the Screen has been either “manually trimmed” or “auto masked”, the Image Centering function moves the image to the center of the print. The Fit function however, fits the image on the Screen onto the entire surface of the print.

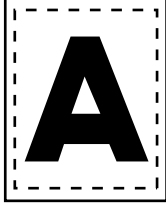
	Screen Image	Print Image	
Centering		Centering: OFF 	Centering: ON 
		Fit: OFF 	Fit: ON 

Centering

- 1 Press the Centering/Fit key to turn ON Centering and then press the Start key.

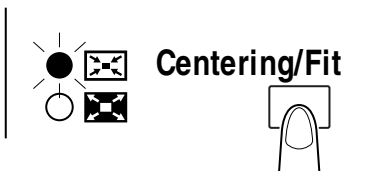

Fit

- 1 Press the Centering/Fit key to turn ON Fit and then press the Start key.

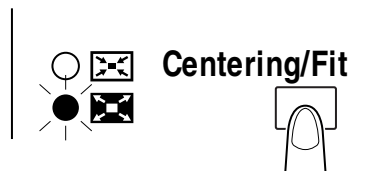

NOTE

Centering/Fit mode cannot be used if  (Masking) is selected.

NOTE

Fit mode cannot be used when the Scanner is connected to the PC.

18. Using the Cycle Print Mode

This function automatically scans the next image following a preset period of time. Images are manually loaded onto the Carrier Glass in between cycles.

This is a system setting that must be entered by an authorized dealer.

If you want to use the Cycle Print Mode, ask your Tech. Rep. to make the necessary system setting. Then you can perform the following operations.

NOTE

This function is only available on the PR mode.

Specifying the interval between scanning operations

- 1** Press the Multi-Print Key to change the value to "A". This enables the Cycle Print Mode. Press the Multi-Print Key to set the interval of time between scan operations. (Refer to the diagram below).

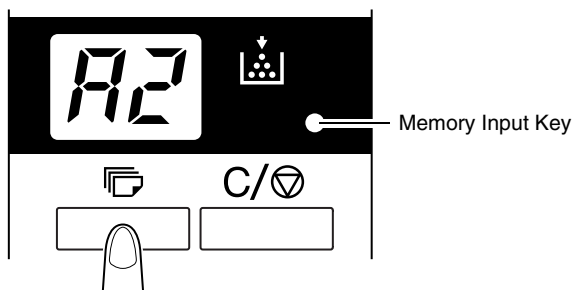

- 2** Press the Memory Input key to store the currently selected interval setting of the Cycle Print Mode into the memory.

Value	1	2	3	4	5	6	7	8	9	0
Period (sec.)	0.5	1.0	1.5	2.0	2.5	3.0	3.5	4.0	4.5	5.0

Operating in the Cycle Print Mode

1 After entering the Cycle Print Mode, press the Start key to start.

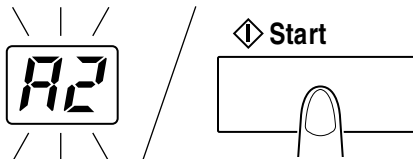

3 While the pause function is enabled, it is possible to exit the Cycle Print Mode by pressing the Clear key a second time (the value displayed in the “No. of Copies” display will change to a “1”).

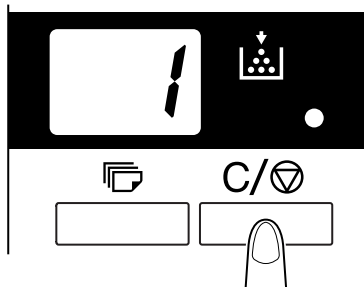

NOTE

- After the first scanning operation has finished, the system will automatically scan the next image following a preset period of time. The system will continue to operate until the Cycle Print Mode is canceled.
- The “No. of Copies” value flashes during the “scanning” and “waiting” operations.
- The next scanning job can be started manually by pressing the Start key before the system automatically initiates the same job.

2 To pause an operation during the Cycle Print Mode, press the Clear key (the “No. of Copies” value will switch from a blinking display to a constant display).

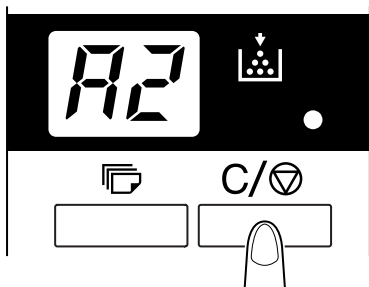

19. Selecting the Connection Mode

The Scanner connection can be selected between PR (connection to the Printer) and PC (connection to the PC).

* For the connection to the PC, the optional interface kit is required.

1 Hold down the Shift Key and the PC/PR Key together for over one second.

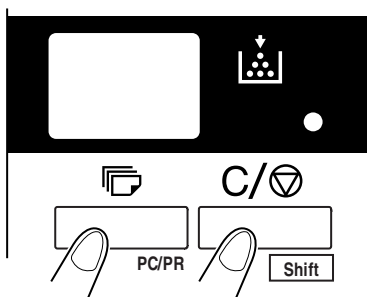

PC mode: When the display is switched from Multi-Print to PC, the connection to the PC is valid.

PR mode: When the display is switched from PC to Multi-Print, the connection to the Printer is valid.

20. Selecting the Resolution

The resolution for scanning (printing) can be selected.

- 1 Press the Shift Key and the Resolution Key together. The present resolution is displayed.

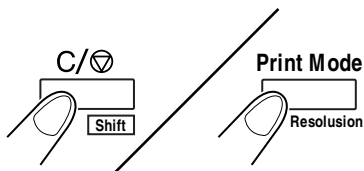

- 2 Press the Resolution Key while holding down the Shift Key to set the resolution.

Connection mode	Resolution	Display
PR mode: MSP 3500 Printer	600 dpi	6H
PR mode: MSP 3000 Printer	400 dpi	4H
	600 dpi	6H
PC mode	200 dpi	2H
	300 dpi	3H
	400 dpi	4H
	600 dpi	6H
	800 dpi *	8H *

* 800 dpi can only be selected when the width of scan area is less than 220mm.

21. Registering the Job Program

The present setting state can be registered in up to 3 program registration locations (1J, 2J and 3J).

- 1 Press the Memory Input Key in the Setting mode. 1J starts blinking.

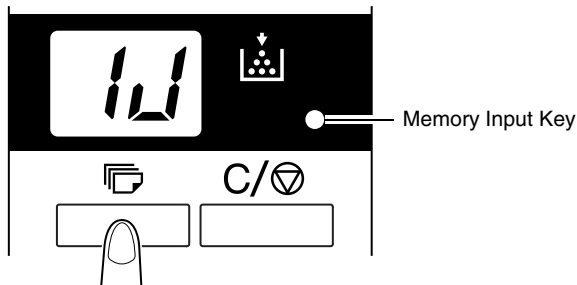

To change the program registration location, press the Multi-Print Key. The display is switched in order of 1J → 2J → 3J → 1J.

- 2 Select the program registration location (1J, 2J or 3J), and press the Memory Input Key again.
- 3 When all LEDs on the control panel light up and then the normal display is resumed, the program registration is over.

The program can be registered up to 3 programs for the PR connection and up to 3 programs for the PC connection.

22. Calling the Job Program

The registered Job program can be called.

- 1 Press the Shift Key and the Job Recall Key together.

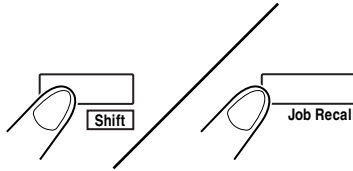

- 2 Each time the Job Recall Key is pressed while the Shift Key is held down, the display is switched in order of 1J → 2J → 3J.
- 3 When the desired setting is displayed, unhand the keys.

23. Using the Electrical Zoom

In addition to the zooming by the Lens, the Electrical Zoom function has been provided for magnifying the image when it is printed.

NOTE

This function is only available on the PR mode.

Zoom +

When the Zoom+ key is pressed together with the Shift Key, the magnification is increased by an increment of 0.01X (up to 2.00X).

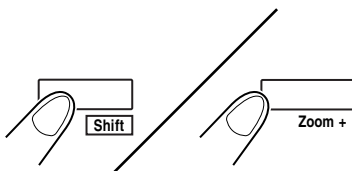

Zoom -

When the Zoom- key is pressed together with the Shift Key, the magnification is decreased by a decrement of 0.01X (down to 0.50X).

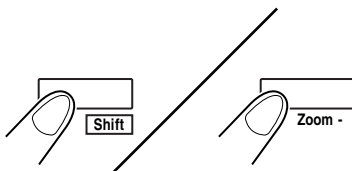

NOTE

The Zoom magnification is displayed in the Multi-Print Display to 2 decimal places.

The Zoom magnification level is displayed in the Exposure Display.

Example: When the magnification is 0.50x, it is displayed as 50. When the magnification is 1.50x, it is displayed as 50 also.

Clearing the Zoom magnification

When the Zoom clr key is held down together with the Shift Key for over one second, the standard magnification is resumed.

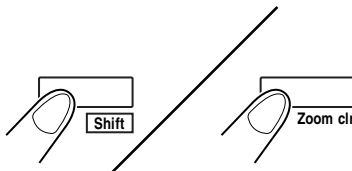

The standard magnification is fixed according to the selected paper size.

Paper size	A3	B4	A4	B5	Ledger	Legal	Letter
Standard magnification	1.41x	1.22x	1.00x	1.00x	1.55x	1.27x	1.00x

NOTE

When the Zoom magnification is changed, the display is made in the Multi-Print Display as follows.

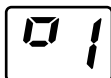

When it is returned to the standard magnification, this display goes off.
When the Zoom function is used, the Multi-Print can be set only up to 9.

24. Adjusting the Illumination of the Screen

The illumination of the screen can be adjusted.

- 1 Hold down the Shift Key and the Illumination Key together to adjust the illumination of the screen.

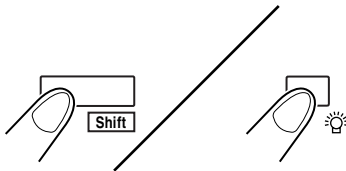

The screen is gradually darkened until it is turned OFF. When any key is pressed, the illumination returns to the maximum level.

25. Replacing the Projection Lamp

Use the following procedure to replace the Projection Lamp whenever a reduction in brightness on the screen is detected or whenever the lamp burns out. Make sure that the replacement lamp is specified for use with this scanner. (DC20V 150W DDL type)

If the Projection Lamp should burn out during a print operation, an L2 code will appear and the print job will stop (a blank piece of paper may be output depending upon the stage of the job). Once the system detects that the Projection Lamp has burnt out, the scan job will be cancelled. If the system is operating in the Cycle Print Mode, the scanning operation will stop.

CAUTION

Do not touch with bare hand and extremely hot Projection Lamp immediately after the scanner has been turned OFF.

- 1 Place the Power Switch in the OFF position and slide the Projection Unit out of the scanner.

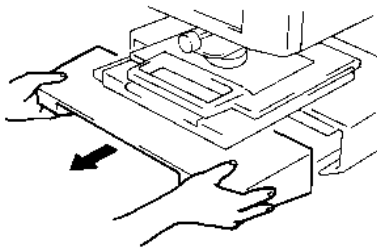

- 3 Remove the Projection Lamp from the Lamp Socket.

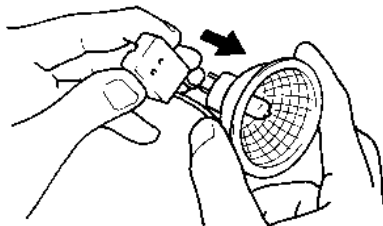

- 2 Remove the Projection Lamp from the Lamp Holder.

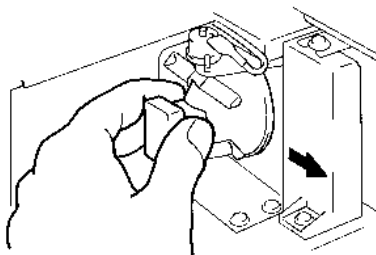

25. Replacing the Projection Lamp

- 4** Insert a new Projection Lamp so that the mark on its base is facing upwards. Make sure that the new Projection Lamp is inserted securely so that there is no gap between the Projection Lamp and the Lamp Socket.

NOTE

Do not touch the reflector mirror surface of the Projection Lamp. Fingerprints, smudges or debris should be wiped clean with a soft, dry cloth.

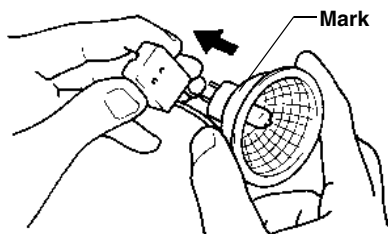

- 5** Insert the new Projection Lamp all the way into the Lamp Holder.

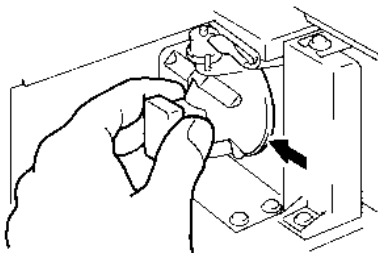

- 6** Slide the Projection Unit back into the scanner.

NOTE

If the Projection Unit is not properly installed, power will not be supplied and the scanner will not operate.

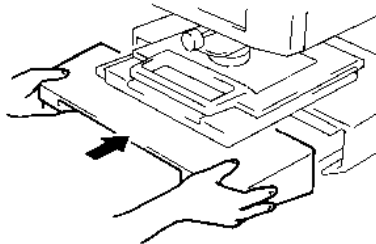

- 7** Turn the Power Switch ON.





Chapter 3

MSP 3500 Printer

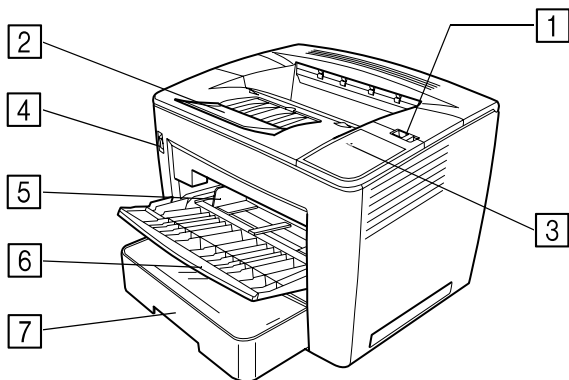
This chapter identifies the different parts of the system and explains the MSP 3500 printer's operational procedures.

1. Parts of the Printer



- | | | |
|----------|-----------------------------------|---|
| 1 | Top Cover Release Lever: | Use to open the Top Cover. |
| 2 | Output Tray Extension: | When printing in paper B4 or larger, fold open. |
| 3 | Power Indicator: | Light indicates when the Printer is turned ON. |
| 4 | Power Switch: | Use to turn the Printer ON and OFF. |
| 5 | Paper Guides: | Slide the guides to secure the paper stack. |
| 6 | Paper Feeding Tray (Open): | Capable of holding up to 250 sheets of standard-size paper ranging from 8-1/2" × 11" (A4)  to 11" × 17" (A3)  paper. |
| 7 | Paper Cassette: | Capable of holding up to 500 sheets of standard-size paper ranging from 5-1/2" × 8-1/2" (B5)  to 11" × 17" (A3)  paper. |

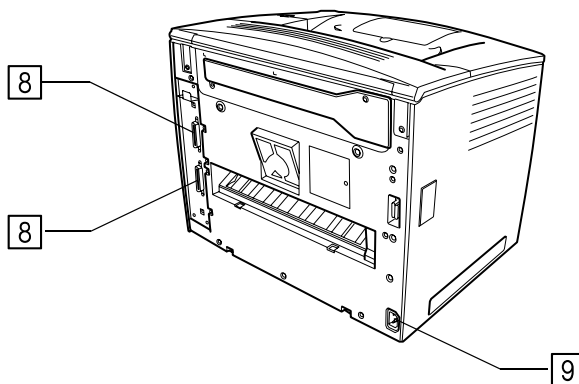

- 8 Interface Connectors:** Facilitates connections for the Scanner. The Printer has two connectors to facilitate connection with two separate Scanner units.
- 9 AC Power Connection:** The power cord is plugged into this socket.

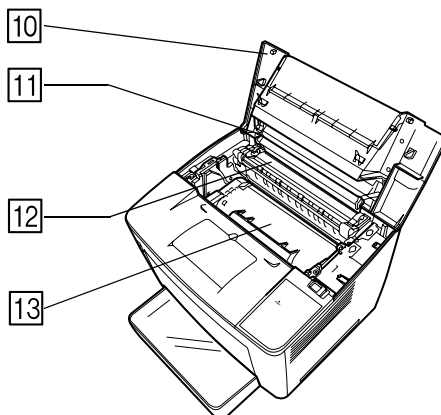

- 10 Top Cover:** Open to replace the Toner Cartridge and to clear misfed sheets of paper.
- 11 Image Transfer Roller:** Transfers the image onto the sheet of paper. Be careful to avoid touching it with your bare hands.
- 12 Fusing Unit:** Permanently fixes the image onto the sheet of paper.
- 13 Toner Cartridge:** Where the image is generated for transfer onto the sheet of paper. Be careful to avoid touching it with your bare hands.

2. Paper Specifications

Use only the following types of paper:

Type Plain and recycled paper (weight 16 to 24 lbs. / 60 to 90 g/m²)

Size Standard sizes: 11" × 17", 8-1/2" × 11", 8-1/2" × 14", A3, A4.

Capacity Paper Feeding Tray:
8-1/2" × 11", 11" × 8-1/2", 8-1/2" × 14", 11" × 17" (or A3, A4)
plain and recycled paper
Up to 200 sheets

Paper Cassette:
11" × 8-1/2", 8-1/2" × 14", 11" × 17" (or A3, A4)
plain and recycled paper
Up to 500 sheets

3. Set the Paper

Loading Paper into the Paper Feeding Tray

- 1 Open the paper feeding tray.

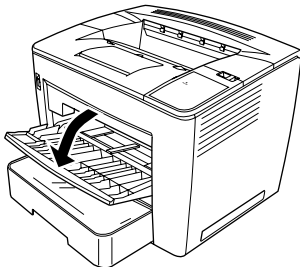

- 2 Fan a stack of paper.

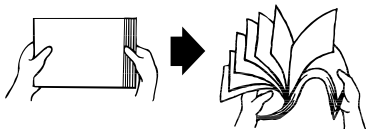

- 3 Align the edges of the paper, and then load it with its printing-side up. Often, an arrow on the paper package label indicates the printing-side of the media.

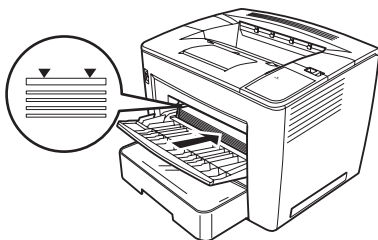

ATTENTION

Do not load paper above the fill limit mark on the inside left of the tray, or it may not feed correctly.

The paper feeding tray holds approximately 200 sheets of 20 lb bond (75 g/m²) paper.

- 4 While pressing the button on the right side of the media guide ①, slide the media guide to adjust it ②.

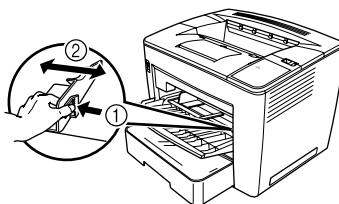

ATTENTION

Make sure the paper fit easily between the guides. Improperly adjusted guides may cause poor print quality, paper jams, or printer damage.

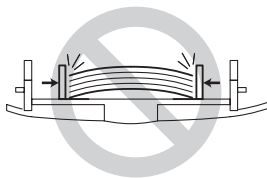

3. Set the Paper

Loading Paper in the Paper Cassette

- 1 Pull out the paper cassette until it stops.

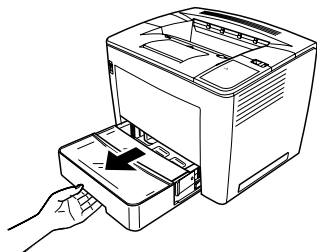

- 2 While pressing the release buttons (one on each side) ①, remove the paper cassette ②.

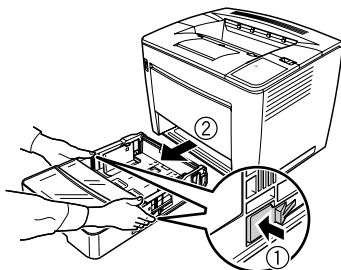

- 3 Remove the cassette cover.

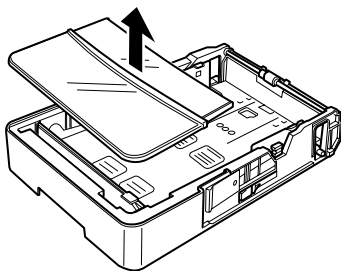

- 4 Lift up the gray lever on the right end of the paper retainer ①, and then slide the paper retainer to the right ②.

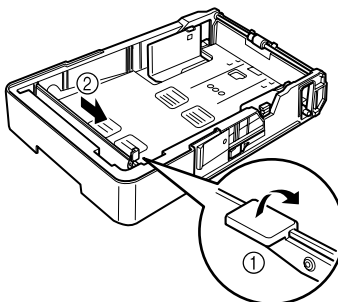

- 5 Lift up on the left end of the paper retainer to remove it.

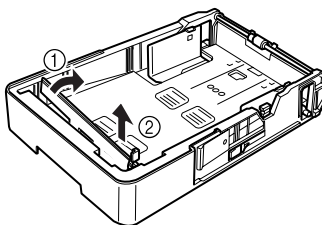

- 6 Insert the right end of the paper retainer ① into the slot for the size of paper to be loaded ②.

The paper size detected depending on the position of the paper retainer. Correctly position the paper retainer according to the size of paper to be loaded.

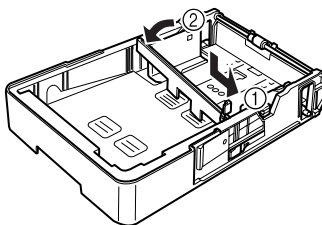

3. Set the Paper

- 7 Slide the paper retainer to the left ①, and then press down on the gray lever ② to secure the paper retainer.

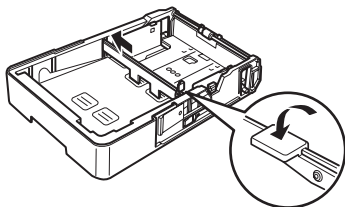
**ATTENTION**

Make sure the paper retainer is seated properly.

- 8 Align the four edges of the paper, and then load the paper printing side up.

Do not load paper on this side.

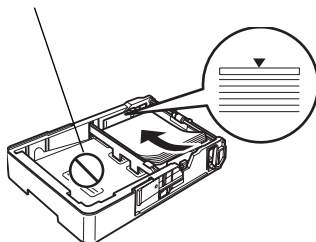

Long-edge Feed Examples
Letter, A4 and B5

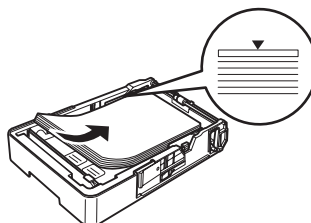

Short-edge Feed Examples
Ledger, Legal, A3 and B4

A maximum of 500 sheets (20 lb pond [75g/m²] plain paper) can be loaded. If paper is loaded past the triangular mark, it may not be fed correctly.

3. Set the Paper

- 9** Press in the button on the paper guide ①, and then slide the guide against the edge of the paper ②.

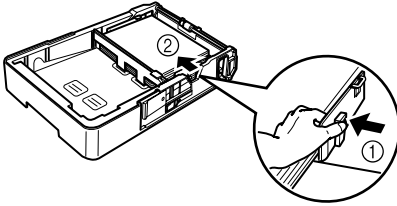

ATTENTION

The paper should fit easily between the guides. Improperly adjusted guides may cause poor print quality, paper jams, or printer damage.

- 10** Install the cassette cover.

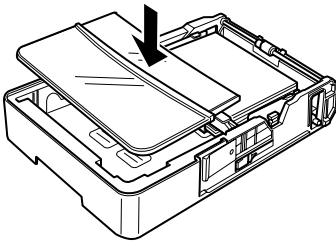

- 11** Install the paper cassette, inserting as far as possible into the printer.

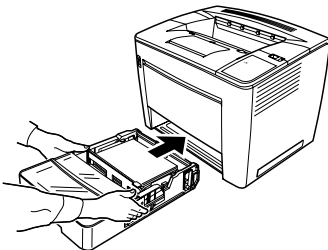

- 12** When printing on paper B4 or larger, fold open the output tray extension.

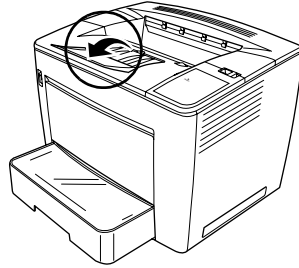

- 13** Affix the paper size labels (supplied with the printer) to the paper cassette in order to indicate the size of loaded paper.

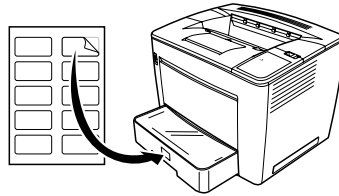

4. Replacing the Toner Cartridge

- 1 Slide the top cover release lever to the right ①, and open the top cover ②.

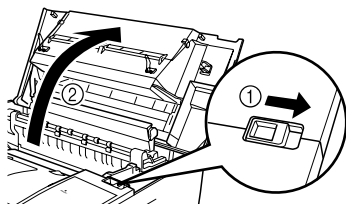

⚠ ATTENTION

Never touch the copper or brass electrodes ① or electrical parts that are located inside the top cover and underneath the toner cartridge, as a printer malfunction can result.

Be careful not to touch ② around the image transfer roller (touching certain parts in this area may result in reduced print quality) or ③ around the fusing unit (since the inside reaches temperatures of about 392 °F (200 °C), touching any part in this area may result in burns).

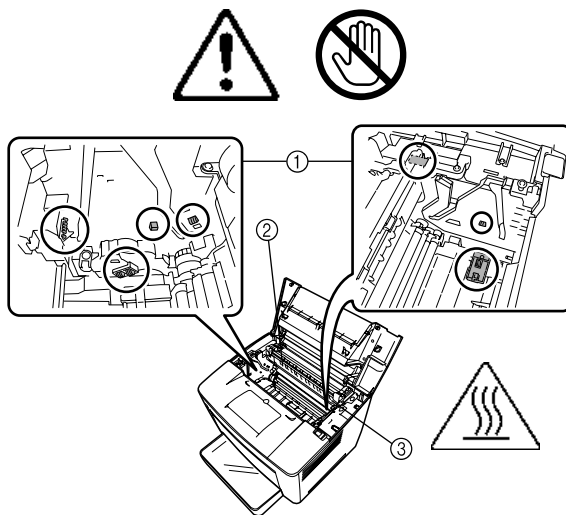

4. Replacing the Toner Cartridge

- 2** Remove the used toner cartridge.

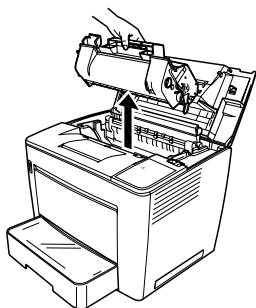

- 3** Remove the new toner cartridge from its protective box.

- 4** Peel off the packing tape.

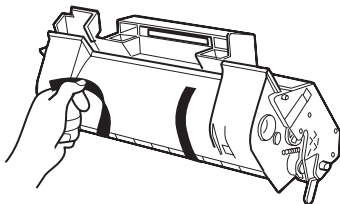

- 5** Slowly shake the toner cartridge, tilting it to the left and right 7 or 8 times to distribute the toner.

The toner is nontoxic. If you get toner on your hands, wash them in cool water and mild neutral detergent. If you get toner on your clothes, lightly dust them off as much as possible. If some toner remains on your clothes, use cool, not hot, water to rinse the toner off, provided your clothing is washable.

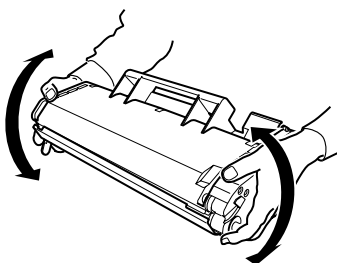

ATTENTION

Hold the toner cartridge by its handle ①. Do not open the protective cover ② of the OPC (the green area ③) or allow anything to come in contact with the OPC. It is extremely sensitive to hand oils and scratches, both of which reduce print quality. This type of damage is not covered by your warranty.

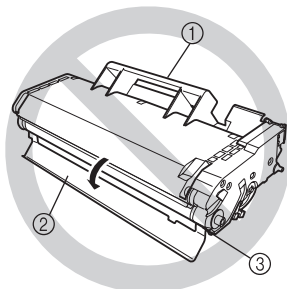

WARNING

If you get toner in your eyes, wash it out immediately with cool water and consult a doctor.

4. Replacing the Toner Cartridge

- 6** Align the tabs on the cartridge (one on each side) with the notches in the printer, and then insert the cartridge as far as possible into its compartment.

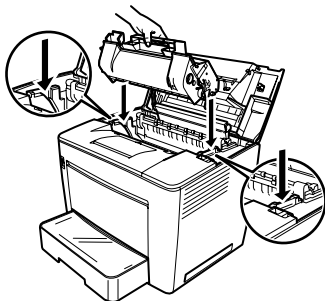

- 7** Close the top cover, pushing it down until it locks into place.

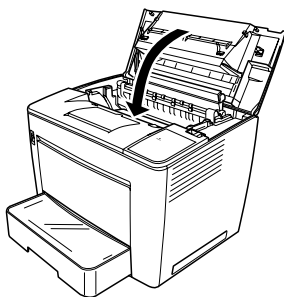

ATTENTION

Do not transport the printer with the toner cartridge installed. If toner spills within the printer, decreased print quality may result or the printer may be damaged.

5. Replacing the Exhaust Filter

The exhaust filter on the back of the printer is replaced when you replace a toner cartridge.

How do I replace the exhaust filter?

- 1 Remove the used exhaust filter.



Dispose of it according to your local regulations.

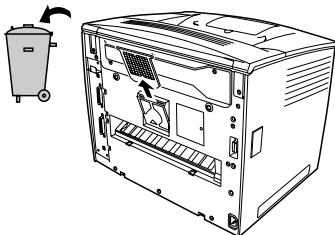

- 2 Remove the new filter from its box and insert it into place.

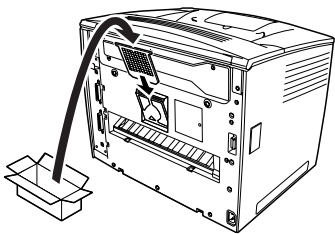

6. When the Paper Misfeed Indicator Lights Up

If the Misfeed Indicator lights up along with a P0 code:

The size or the direction of the paper loaded in the paper tray does not match that set for the tray.

Load the paper of the set size in the set direction and then open and close the Upper Unit.

If the Misfeed Indicator lights up along with a P1, P2 or P3 code:

A misfeed has occurred in the Printer. Clear the sheet of misfed paper by following the procedure given below.

CAUTION

The Fusing Unit inside the printer becomes very hot during operation. To avoid a burn, be very careful not to touch it.

6. When the Paper Misfeed Indicator Lights Up

Clearing a Misfeed from the Paper Feeding Tray

- 1 Remove all paper from the paper feeding tray.

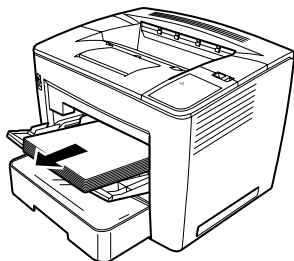

- 2 Pull out the misfed paper.

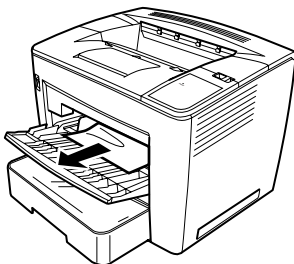

- 3 Correctly load the paper into the paper feeding tray.

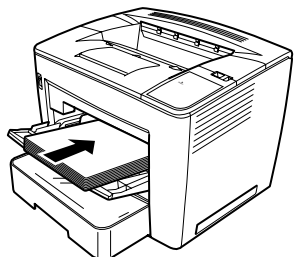

- 4 If necessary, open and close the top cover to cancel Misfeed Code.

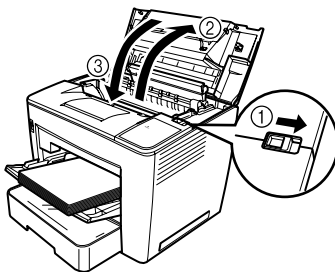

6. When the Paper Misfeed Indicator Lights Up

Clearing a Misfeed from the Paper Cassette

- 1** Pull out the cassette until it stops.

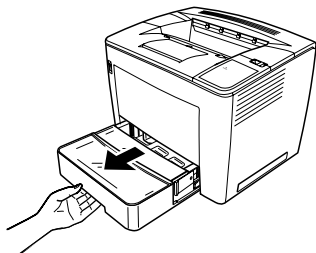

- 2** While pressing in the release buttons (one on each side), remove the cassette.

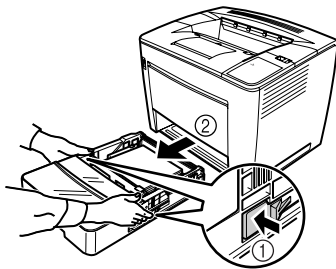

- 3** Pull out the misfeed paper.



Make sure no paper remains under the roller in the cassette.

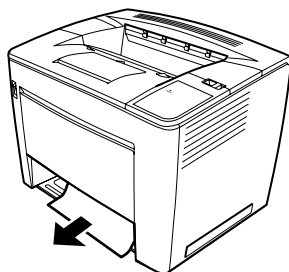

- 4** If the misfeed paper cannot easily be pulled out, lift the green lever ① on the inner-right side to release the paperfeed roller, and then pull out the paper ②. After removing the misfeed paper, be sure to return the green lever to its original position ③. Do not use force to remove jammed paper.

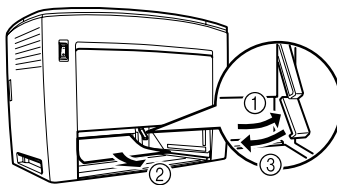

- 5** Install the cassette, inserting it as far as possible into the printer.



Check that the paper remaining in the cassette is loaded correctly before installing the cassette.

Make sure no paper remains misfeed under the roller in the cassette.

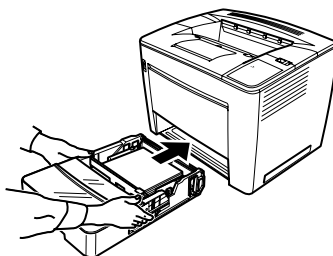

6. When the Paper Misfeed Indicator Lights Up

Clearing a Misfeed from inside the Printer

- 1 Open the top cover.

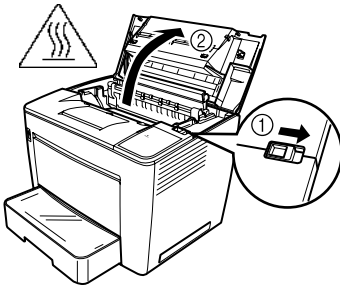

⚠ ATTENTION

Never touch the copper or brass electrodes ① or electrical parts that are located inside the top cover and underneath the toner cartridge, as a printer malfunction can result.

Be careful not to touch ② around the image transfer roller (touching certain parts in this area may result in reduced print quality) or ③ around the fusing unit (since the inside reaches temperatures of about 392 °F (200 °C), touching any part in this area may result in burns).

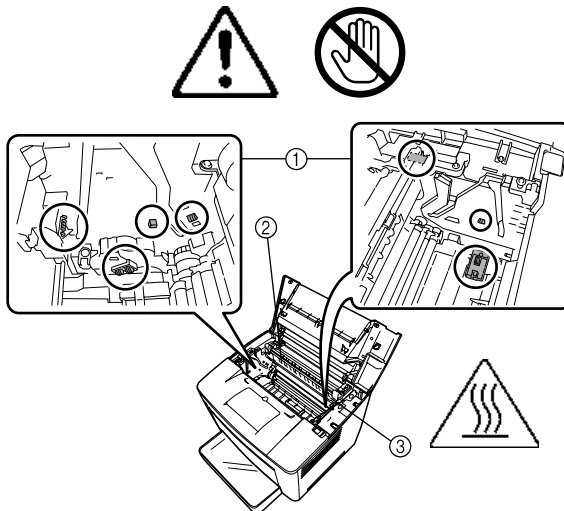

6. When the Paper Misfeed Indicator Lights Up

- 2** Remove the toner cartridge and store it in a light-free protective bag.

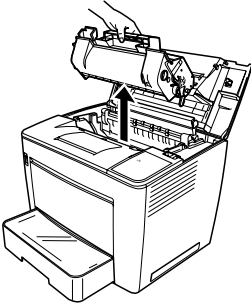

- 4** After removing the misfeed paper, lower the two levers.

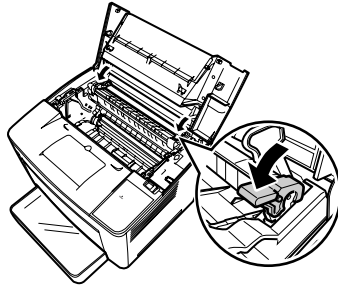

- 3** If the paper is stopped by the fuser, lift the green levers on each side, and then slowly pull out the paper from the roller.

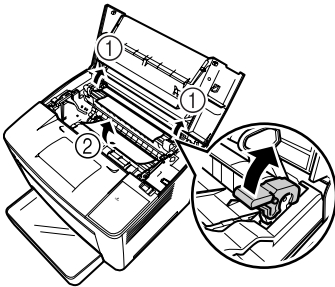

- 5** Open the paper feed roller cover.

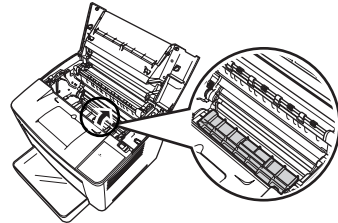

- 6** Pull out the jammed paper.

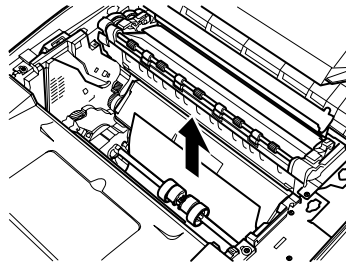

ATTENTION

Do not pull out the paper from above the roller; otherwise, decreased print quality may result.

6. When the Paper Misfeed Indicator Lights Up

7 Close the paper feed roller Cover.

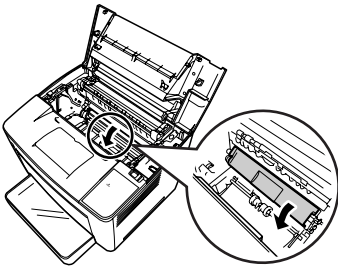

9 Close the top cover.

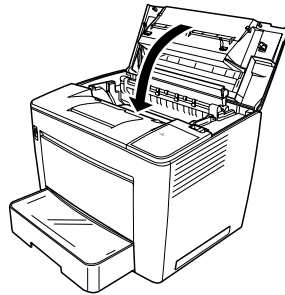

8 Align the tabs on the toner cartridge (one on each side) with the notches in the printer, and then insert the cartridge as far as possible.

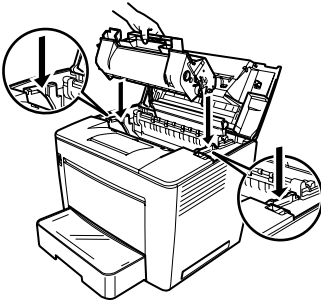

Clearing a Misfeed from output bin

- 1** Remove the paper from the output bin.
- 2** If necessary, gently pull out any paper that is still jammed.

ATTENTION

Do not touch the rollers or gears within the printer; otherwise, the printer may be damaged.

Chapter 4

MSP 3000 Printer

This chapter identifies the different parts of the system and explains the MSP 3000 printer's operational procedures.

1. Parts of the Printer

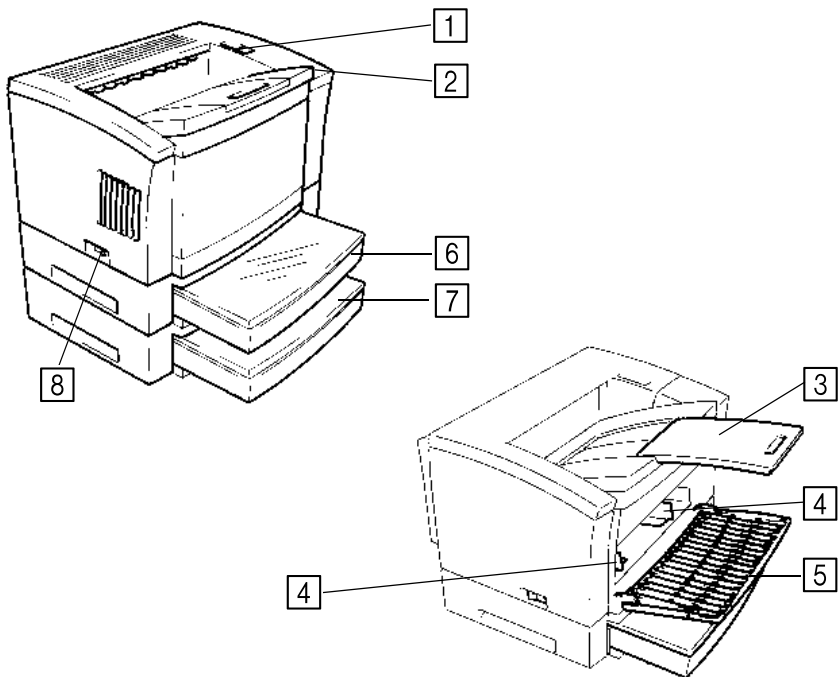

1 Upper Unit Lock Release Lever:

Use to open the Upper Unit.

2 Power Indicator:

Light indicates when the Printer is turned ON.

3 Print Tray:

Prints are output from the Printer, face down onto this tray which can hold up to 500 sheets of standard paper.

4 Paper Guides:

Slide the guides to secure the paper stack.

5 Paper Feeding Tray: (Tray)

Capable of holding up to 150 sheets of standard-size paper. (8-1/2" × 11", 11" × 17", 8-1/2" × 14" or A3, B4, A4)

6 Cassette 1:

Capable of holding up to 250 sheets of standard-size paper. (8-1/2" × 11", 11" × 17", 8-1/2" × 14" or A3, B4, A4)

7 Cassette 2: (option)

Capable of holding up to 250 sheets of standard-size paper. (8-1/2" × 11", 11" × 17", 8-1/2" × 14" or A3, B4, A4)

8 Power Switch:

Use to turn the Printer ON and OFF.

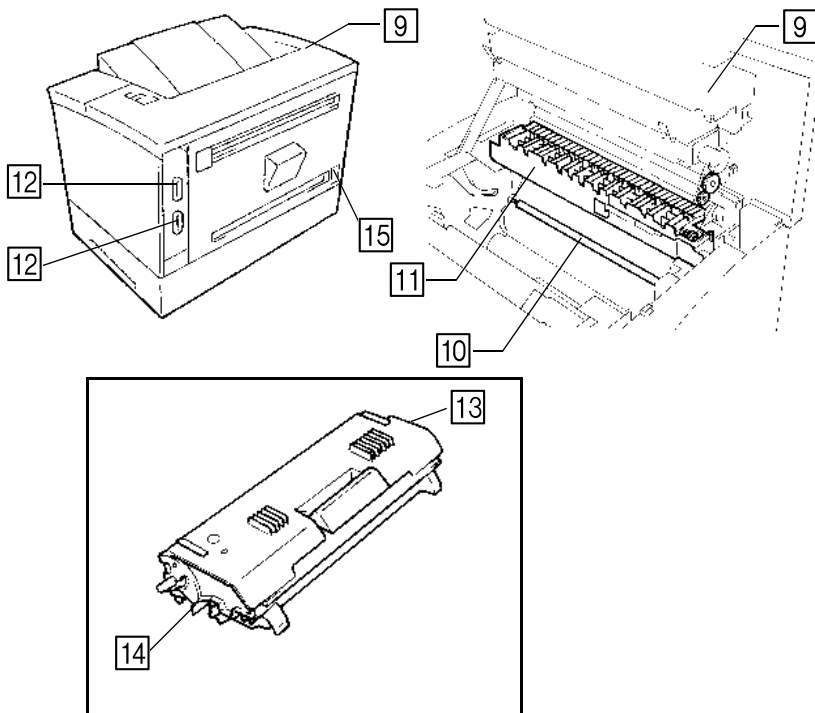

- 9 Upper Unit:** Open to replace the Imaging Cartridge and to clear misfed sheets of paper.
- 10 Image Transfer Roller:** Transfers the image onto the sheet of paper. Be careful to avoid touching it with your bare hands.
- 11 Fusing Unit:** Permanently fixes the image onto the sheet of paper.
- 12 Interface Connectors:** Facilitates connections for the Scanner.
* The Printer has two connectors to facilitate connection with two separate Scanner units.
- 13 Imaging Cartridge:** Where the image is generated for transfer onto the sheet of paper. Be careful to avoid touching it with your bare hands.
- 14 Seal:** Remove the seal before installing the new cartridge.
- 15 Power Cord Socket:** The power cord is plugged into this socket.

2. Paper Specifications

Use only the following types of paper

Type Plain and recycled paper (weight 16 to 24 lbs. / 60 to 90 g/m²)

Size Standard sizes: 11" × 17", 8-1/2" × 11", 8-1/2" × 14" (or A3, B4, A4).

Capacity Paper Feeding Tray:
8-1/2" × 11", 11" × 8-1/2", 8-1/2" × 14", 11" × 17" (or A3, B4, A4)
plain and recycled paper
Up to 150 sheets

Paper Cassette:
8-1/2" × 11", 11" × 8-1/2", 8-1/2" × 14", 11" × 17" (or A3, B4, A4)
plain and recycled paper
Up to 250 sheets

3. Set the Paper

Loading Paper into the Paper Feeding Tray

- 1 Swing down the Paper Feeding Tray.

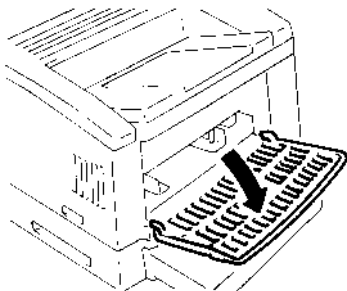

- 2 Fan the paper stack thoroughly and align the edges.



- 3 Load the paper stack face up in the tray and adjust the Paper Guides to secure the paper stack.

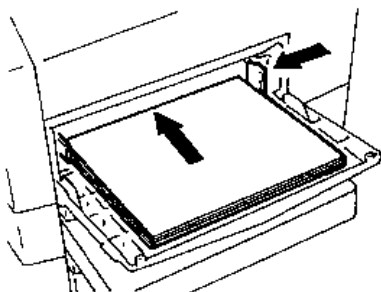

NOTE

- Make sure that the paper stack does not exceed the Maximum Level Indicator.

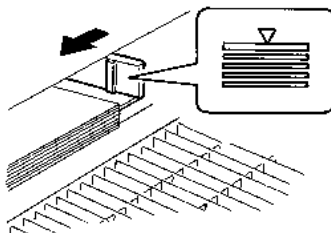

- Load a new paper stack only after the old one has run out.

- 4 Close the Paper Feeding Tray.

3. Set the Paper

Loading Paper in the Paper Cassette

- 1 Pull the cassette out of the Printer and open the Cover.

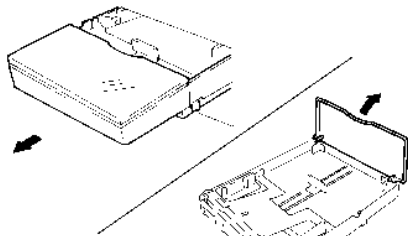

- 2 Press down the Paper Lifting Plate until it locks. Fan the paper stack thoroughly, align the edges, and place the paper in the cassette.

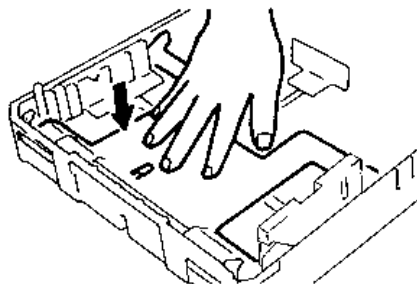

- 3 Secure the paper stack in the Paper Cassette with the Paper Guides.

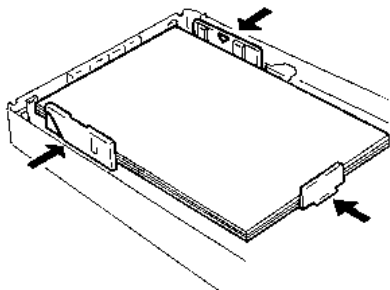

NOTE

- Make sure that the paper stack does not exceed the Maximum Level Indicator.
- Load a new paper stack only after the old one has run out.

- 4 Close the Cover and insert the cassette into the Printer.

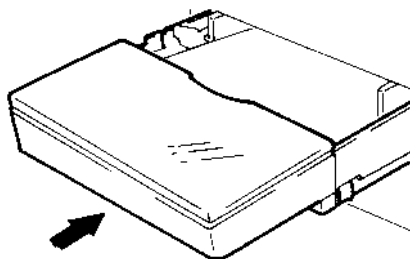

4. Replacing the Toner Cartridge

- 1** Open the upper unit by pulling the Upper Unit Lock Release Lever forward.

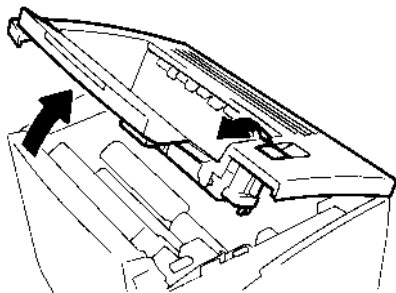

NOTE

Push the Print Tray in before opening the Upper Unit.

- 2** Remove the old Imaging Cartridge from the printer.

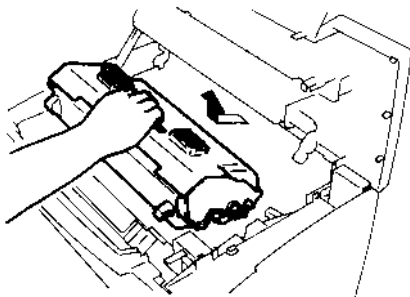

- 3** Take a new Imaging Cartridge out of the box. Holding it with both hands, shake it well in the directions indicated by the arrows.

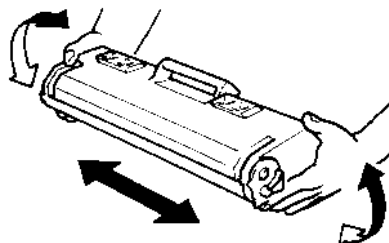

- 4** Remove the seal from the Imaging Cartridge by pulling it steadily straight out.

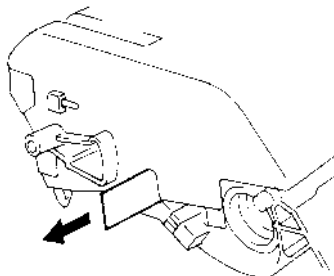

- 5** Shake the Imaging Cartridge four or five more times as shown to evenly distribute the toner inside.

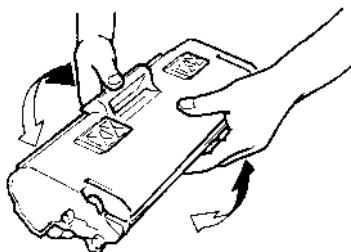

4. Replacing the Toner Cartridge

- 6** Slide the pins located on both sides of the Imaging Cartridge into the grooves of the printer as shown and gently push the Imaging Cartridge securely into place.

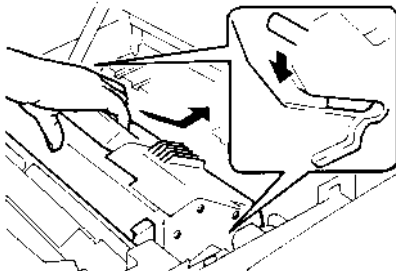

- 7** Close the Upper Unit.

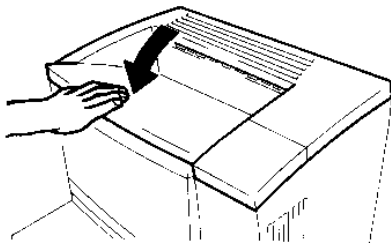

5. When the Paper Misfeed Indicator Lights Up

If the Misfeed Indicator lights up along with a P0 code:

The size or the direction of the paper loaded in the paper tray does not match that set for the tray.

Load the paper of the set size in the set direction and then open and close the Upper Unit.

If the Misfeed Indicator lights up along with a P1, P2 or P3 code:

A misfeed has occurred in the Printer. Clear the sheet of misfed paper by following the procedure given below.

CAUTION

The Fusing Unit inside the printer becomes very hot during operation.

To avoid a burn, be very careful not to touch it.

5. When the Paper Misfeed Indicator Lights Up

Clearing a Misfeed from the Paper Feeding Tray

- 1** Open the Upper Unit by pulling the Upper Unit Lock Release Lever forward.

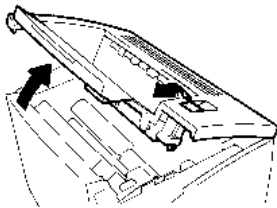

NOTE

Push the Print Tray in before opening the Upper Unit.

- 2** Remove the Imaging Cartridge.

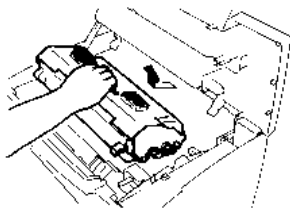

NOTE

Be sure to cover the Imaging Cartridge with a heavy cloth to protect it from light when it is removed from the Printer.

- 3** Remove the sheet(s) of paper that caused the misfeed from the Paper Feeding Tray.

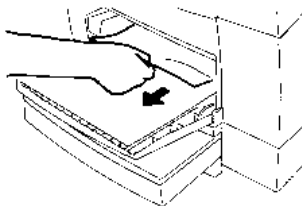

- 4** Check that no misfed paper is left in the Printer and then reinstall the Imaging Cartridge.

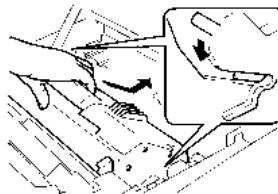

- 5** Close the Upper Unit.

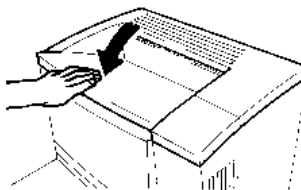

5. When the Paper Misfeed Indicator Lights Up

Clearing a Misfeed from the Paper Cassette

- 1 Open the Upper Unit by pulling the Upper Unit Lock Release Lever forward.

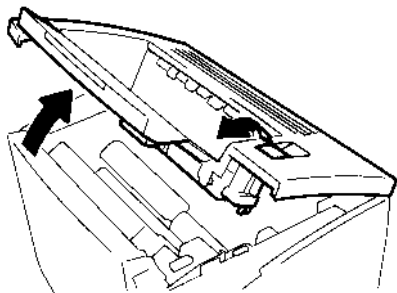

NOTE

Push the Print Tray in before opening the Upper Unit.

- 2 Remove the Imaging Cartridge.

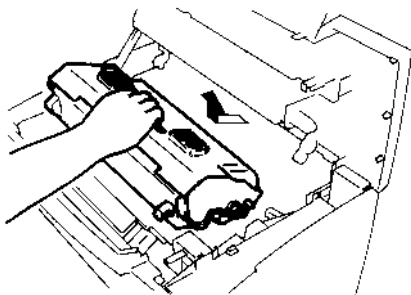

NOTE

Be sure to cover the Imaging Cartridge with a heavy cloth to protect it from light when it is removed from the Printer.

- 3 Pull out the Cassette and remove the sheet(s) of paper that caused the misfeed as shown.

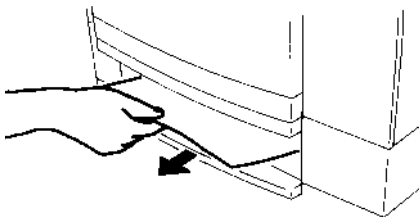

- 4 Check that no misfed paper is left in the Printer and then reinstall the Imaging Cartridge.

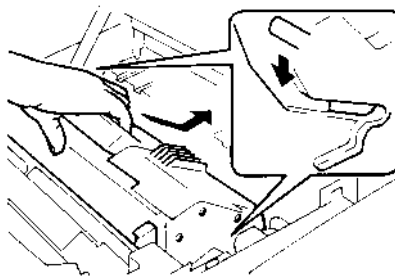

- 5 Close the Upper Unit.

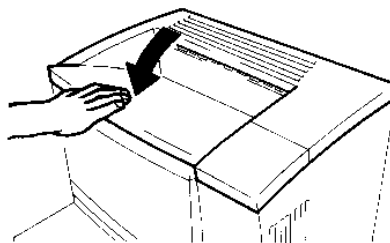

5. When the Paper Misfeed Indicator Lights Up

Clearing a Misfeed from inside the Printer

- 1 Open the Upper Unit by pulling the Upper Unit Lock Release Lever forward.

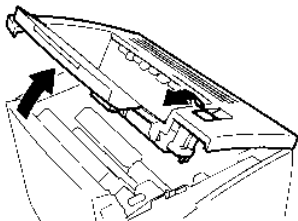

NOTE

Push the Print Tray in before opening the Upper Unit.

- 2 Remove the Imaging Cartridge.

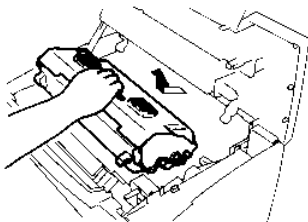

NOTE

Be sure to cover the Imaging Cartridge with a heavy cloth to protect it from light when it is removed from the Printer.

- 3 If the misfeed occurred before the sheet of paper entered the Fusing Unit, gently pull the misfed sheet up and out as shown.

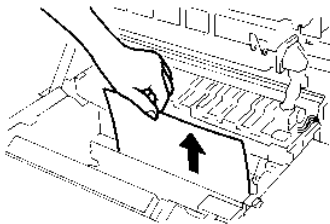

- 4 If the misfeed occurred after the sheet of paper entered the Fusing Unit, gently pull the misfed sheet toward you and out as shown.

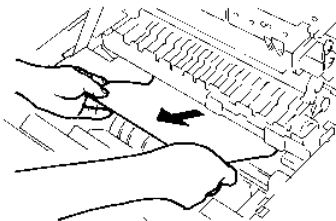

NOTE

- Since the toner has not yet been fixed onto the sheet of paper, be careful not to soil your hands or clothes when pulling out the misfed sheet.
- Do not remove the misfeed by pulling on the sheet of paper toward the output end of the Fusing Unit as shown.

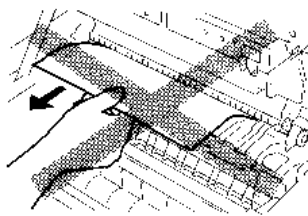

- 5 Reinstall the Imaging Unit and close the Upper Unit.

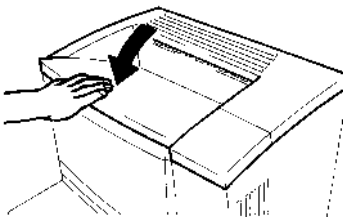

Chapter 5

Troubleshooting

1. Solving Irregular Printing Problems

Use the following procedures to fix minor printing problems. If print quality does not improve after implementing the procedures below, contact your Technical Representative.

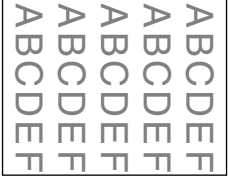
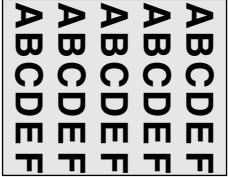
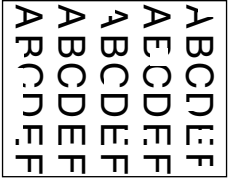
Symptom	Cause	Action
<p>Light image</p> 	<p>Print density is not properly set.</p> <p>Toner in the Imaging Cartridge is running out.</p>	<p>Change the print density setting as necessary.</p> <p>Replace the Imaging Cartridge with a new one.</p>
<p>Dark image</p> 	<p>Print density is not properly set.</p>	<p>Change the print density setting as necessary.</p>
<p>Partial void image</p> 	<p>The paper in the tray is damp.</p>	<p>Replace the damp paper with fresh, dry paper.</p>

1. Solving Irregular Printing Problems

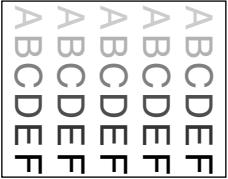
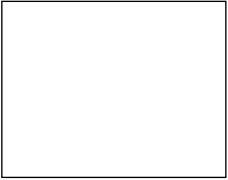
Symptom	Cause	Action
<p data-bbox="165 209 381 233">Uneven image density</p> 	<p data-bbox="441 209 713 288">Toner in the Imaging Cartridge is not evenly distributed.</p>	<p data-bbox="729 209 1001 288">Remove the Imaging Cartridge, shake it several times and replace.</p>
<p data-bbox="219 470 331 494">Blank print</p> 	<p data-bbox="441 470 713 518">The Printer has malfunctioned.</p>	<p data-bbox="729 470 1001 518">Contact your Technical Representative.</p>

1. Solving Irregular Printing Problems

Chapter 6

Maintenance

1. System Care

The system should be cleaned on a daily basis for optimal operating conditions.

Cleaning the Scanner Screen

- 1 With a damp cloth, clean and remove any dust or debris from the surface of the Screen.

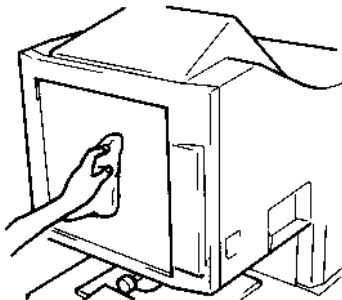

NOTE

NEVER use alcohol or any other solvent when cleaning to avoid causing damage to the Screen or erasing the frame size markers.

Carrier Glass (Option)

- 1 With a damp cloth, clean and remove any dust or debris from the surface of the Carrier Glass.

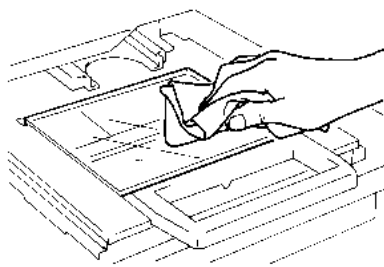

NOTE

Before cleaning the Carrier Glass, be sure to remove the Projection Lens from the Scanner.

Outer Covers

- 1 Dust the exterior panels of the Scanner with a soft, dry cloth.

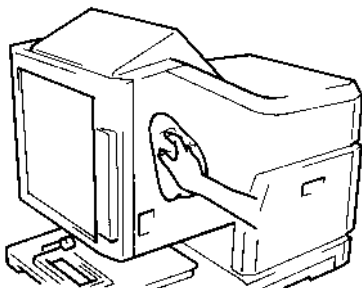

- 2 To open the Carrier Glass, pull the handle of the Microfiche Holder. Following the same procedure described in Step 1, wipe the inner surfaces of the Carrier Glass.

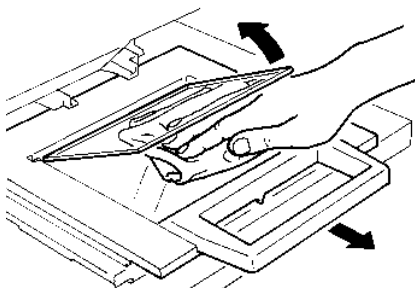

- 3 Dry and polish the glasses with a soft, dry cloth to prevent spotting or smearing.

Cleaning the System Printer (Option)

Clean the Printer at regular intervals.

Cleaning the MSP 3500 Printer

When does the printer need cleaning?

Clean this item thoroughly...	After...
Exterior	Once a month or as needed, whichever comes first.
Interior (paper feed rollers)	Paper stops being fed from the paper tray(s).
Note: We recommend that you do not clean elsewhere inside the printer. If necessary, contact the authorized dealer.	

What cleaning materials should I use?

Exterior—Use	Exterior—Avoid
A soft dry cloth to clean the control panel.	Sharp or rough implements (such as wire or plastic cleaning pads or brushes); liquids.
A soft, wrung-out damp cloth to clean the outside of the printer.	Aerosol or pump-sprayed cleaners; too much dampness in the cloth.
Mild neutral detergent to clean the outside of the printer, if necessary.	Abrasive or corrosive solutions that contain solvents (such as alcohol, benzine, or thinners).
Interior Paper Feed Rollers—Use	Interior—Avoid
A soft dry clean cloth.	Sharp or rough implements (such as wire or plastic cleaning pads or brushes); any liquids.

1. System Care

Cleaning the Printer Exterior

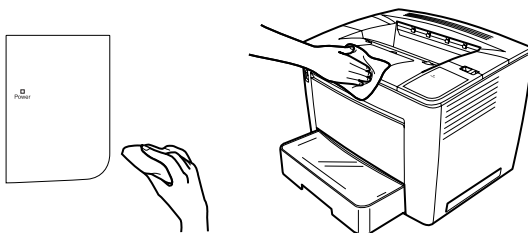

⚠ ATTENTION

Never spray cleaning solution directly on the printer's surface; the spray could penetrate through the air vents of the printer and damage the internal circuits.

Cleaning the Printer Interior

Make sure any parts removed during cleaning are replaced before you plug in the printer.

WARNING

- *Turn off the printer, unplug the power cord, and disconnect all interface cables before cleaning.*
 - *Do not spill water or detergent into the printer; otherwise the printer will be damaged and an electric shock may occur.*
 - *Read all caution and warning labels carefully, making sure to follow any instructions contained in them. These labels are located on the printer's interior.*
-

Paper Pickup Rollers

The printer's pickup rollers contain a sensor to detect the density of media passing by.

How do I clean the paper feeding tray pickup rollers?

- 1 Turn off the printer.
- 2 Open the top cover.

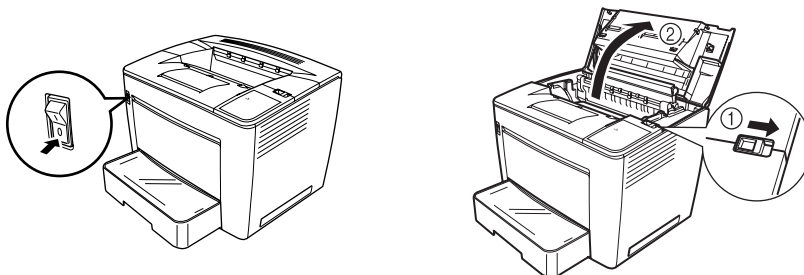

! ATTENTION

Never touch the copper or brass electrodes ① or electrical parts that are located inside the top cover and underneath the toner cartridge, as a printer malfunction can result.

Be careful not to touch ② around the image transfer roller (touching certain parts in this area may result in reduced print quality) or ③ around the fusing unit (since the inside reaches temperatures of about 392 °F (200 °C), touching any part in this area may result in burns).

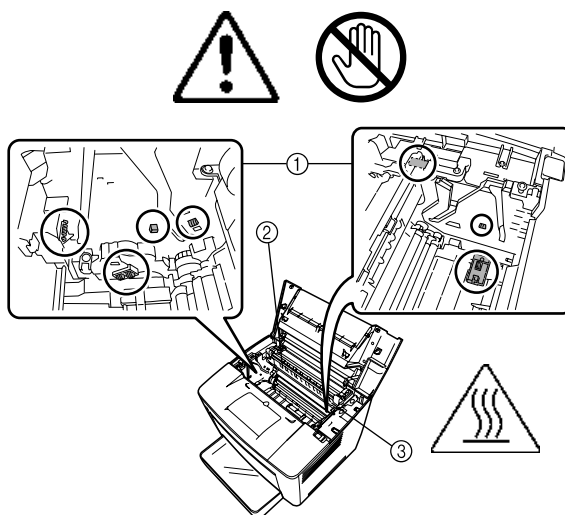

1. System Care

- 3 Remove the toner cartridge and store it in a light-protected bag.

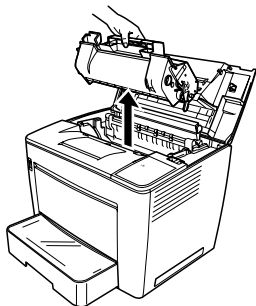

- 4 Open the paper feed roller cover.

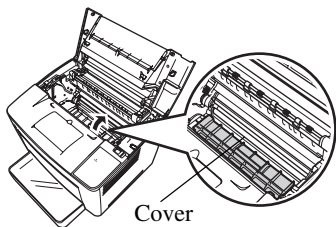

- 5 Wipe the two paper feed rollers with a soft, dry cloth.

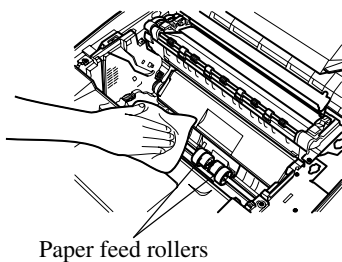

- 6 Close the paper feed roller cover.

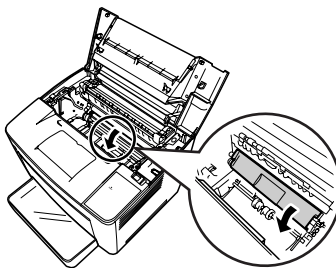

- 7 Align the tabs on the cartridge (one on each side) with the notches in the printer, and then insert the cartridge as far as possible into its compartment.

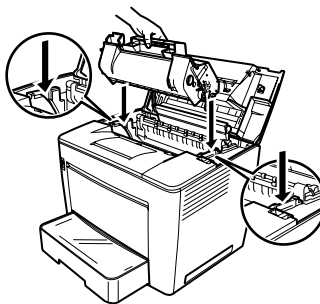

- 8 Close the top cover.

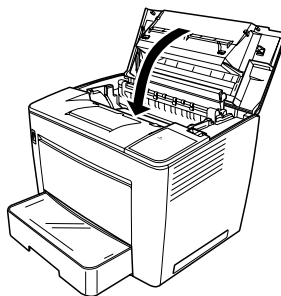

- 9** Turn on the printer.

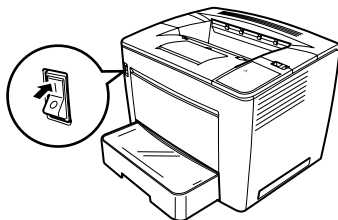

- 3** Wipe the pickup roller with a soft dry cloth.

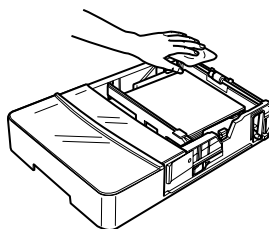

How do I clean the paper cassette pickup rollers?

When the sensor gets dirty or dusty, print quality is degraded.

- 1** Pull the paper cassette out of the printer until it stops.

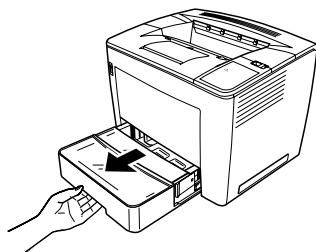

- 2** Remove the paper cassette.

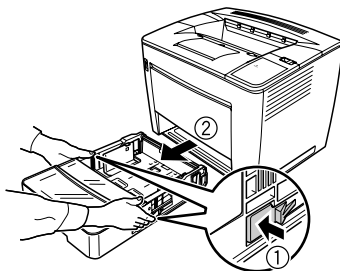

- 4** Reinsert the paper cassette into the printer.

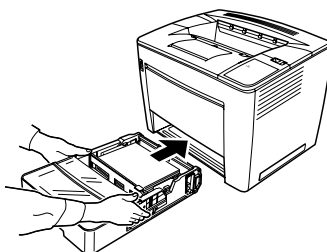

1. System Care

Cleaning the MSP 3000 Printer

CAUTION

Use a soft cloth and NEVER use abrasives or corrosive detergents.

1 Before cleaning the Printer, turn OFF the power and unplug the cord from the power outlet.

2 Clean the exterior panels with a soft, dry cloth.

A damp cloth and a mild home detergent can be used for heavier cleaning.

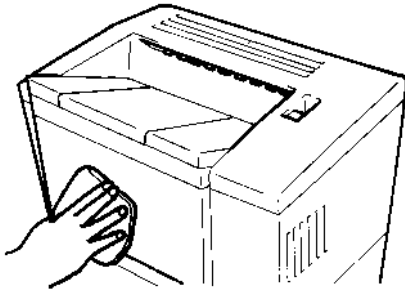

Chapter 7

Miscellaneous

1. Specifications

Specifications	
Type:	Desk-Top Type Microfilm Scanner
Type of Film:	Microfiche, Jackets, Aperture Cards, 16mm & 35mm Roll Film, 16mm Film Cartridges.
Magnification:	7.5x, 9x-16x, 13x-27x, 23x-50x
Screen:	12" x 12" (300mm x 300mm)
Image Rotation:	Prism Rotation, Carrier Rotation (Fiche Carrier)
Scanning Method:	Scanning/Scanning direction: CCD scanning Scanning/Feeding direction: Mirror scanning
Exposure Control:	Automatic & Manual
Light Source:	Halogen Lamp (DC20V 150W DDL Type)
Power Requirement:	120VAC (60Hz) or 220-240VAC (50-60Hz)
Power Consumption:	Less than 350W Auto Power Save Mode: Less than 6W (120V areas) Less than 8W (220V areas)
Dimensions:	19-3/4"(W) x 32-3/8"(D) x 28-1/4"(H) (503 x 821 x 716 mm)
Weight:	92-1/2 lbs. (42kg)
Standard Accessories:	Power Cord, Printer cable, Prism Unit, User's Guide (this manual)
Options:	Projection Lenses, Fiche Carrier 5, Universal Carrier UC-2, Roll Film Carrier 15A/15M, MARS MINI CONTROLLER 2, Manual Frame Masking Kit, Counter Kit, Foot Switch Kit, Grayscale Memory Board, USB Interface Kit, PC Interface Kit, Energy Miser Kit (for USA and Canada only)

1. Specifications

PC Mode

Specifications	
Resolution:	200, 300, 400, 600, 800 dpi
Output Scale:	Binary, Grayscale (Option)
PC Interface:	USB2.0 Hi-Speed (Option) SCSI-2 (Option)

PR Mode : MSP 3500 Printer

Specifications	
Resolution:	600 dpi
Output Scale:	Binary
Printing Method:	Laser Electrostatic
Developing System:	Super Micro-Toning (Super-MT) System
Print Size:	8-1/2" x 11" (or A4) Crosswise, 11" x 17" (or A3) Lengthwise 8-1/2" x 11" (or A4) Lengthwise, 8-1/2" x 14" (or B4) Lengthwise
Warm-up Time:	Less than 70 seconds
First Print Time:	19.0 seconds (11" x 17" or A3 , 600 dpi, AE) 16.5 seconds (8-1/2" x 11" or A4 , 600 dpi, AE)
Print Speed:	18.5 sheets per minute (11" x 17" or A3 , 600 dpi) 34 sheets per minute (8-1/2" x 11" or A4 , 600 dpi)
Multiple Printing:	1-19 sheets (LED countdown identification)
Paper Supply:	Automatic Feeding Supply Paper Feeding Tray (200 sheets max.) Paper Cassette (500 sheets max.)
Printer's Power Consumption:	Less than 1100 W
Printer's Dimensions:	21.2"(W) x 22.2"(D) x 17"(H) or 539(W) x 566(D) x 423(H) mm
Printer's Weight:	71-3/4 lbs. (32.5kg) <Including Toner Cartridge>

1. Specifications

PR Mode : MSP 3000 Printer

Specifications	
Resolution:	400, 600 dpi
Printing Method:	Laser Electrostatic
Developing System:	Fine Micro-Toning (Fine-MT) System
Print Size:	8-1/2" x 11" (or A4) Crosswise, 11" x 17" (or A3) Lengthwise 8-1/2" x 11" (or A4) Lengthwise, 8-1/2" x 14" (or B4) Lengthwise
Warm-up Time:	Less than 70 seconds
First Print Time:	15.2 seconds (11" x 17" or A3 , 400 dpi, AE) 13 seconds (8-1/2" x 11" or A4 , 400 dpi, AE)
Print Speed:	15 sheets per minute (11" x 17" or A3 , 400 dpi) 20 sheets per minute (8-1/2" x 11" or A4 , 400 dpi)
Multiple Printing:	1-19 sheets (LED countdown identification)
Paper Supply:	Automatic Feeding Supply Paper Feeding Tray (150 sheets max.) Paper Cassette 1 (250 sheets max.) Paper Cassette 2 (250 sheets max.): Option
Printer's Power Consumption:	Less than 750W
Printer's Dimensions:	22"(W) x 20-1/2"(D) x 16"(H) or 561(W) x 521(D) x 409(H) mm
Printer's Weight:	67-3/4 lbs. (28kg) <Including Imaging Cartridge>

* Specifications subject to change without notice.

2. Initial Settings

This system offers three types of settings: the user settings that are made by the user on the control panel, the settings that are made by the user using with the User Mode, and the system settings that are made by the authorized dealer.

User Settings on the Control Panel

User Settings	Initial Setting	Remark
Exposure mode	Auto	
Print image density	Center	
Paper Selection	A4 (Letter) crosswise	See p. 7-9, U4: Paper Feeding Tray Size.
	Rotation OFF	
Film type	Auto	
Auto Skew Correction	OFF	
Auto Masking	OFF	
Manual Masking	—	Enabled only when the Manual Frame Masking Kit (option) is mounted.
Centering/Fit	OFF	
Print Mode	Text	
Resolution	600 dpi	MSP 3500 Printer
	400 dpi	MSP 3000 Printer

- * When any of these functions has been changed and you want to store that new setting in the system's memory, press the Memory Input Key.

2. Initial Settings

User Mode

User mode allows the default values of various functions to be set or changed as necessary. Setting these default values according to the need of the user saves labor in making settings again each time the power is turned ON or Panel Reset is activated.

Display	Function Name	Description
U1	Special Print Mode	Not available.
U2	Engineering Enhancement Mode	Corrects slight image distortion occurring in the scan direction.
U3	Auto Power Save	Used to set the time it takes the unit to be automatically set into the Auto Power Save mode.
U4	Paper Feeding Tray Size	Used to set the size and direction of the paper loaded in the Paper Feeding Tray.
U5	Imprint Position Setting	Used to turn ON or OFF the Date Print and Character Overlay functions, and to set the date print position for the Date Print function.
U6	Year, Month and Date Set Mode	Used to set the print pattern for the Date Print function.
U7	Imprint Mode Set	Used to correct the time-of-day for the Date Print function when it becomes wrong.
U8	Total Scan Counter	Used to display the number of scan sequences carried out by the Scanner.

Entering and Leaving the User Mode

- 1** Hold down the Shift key and Output Selection key at the same time for 0.5 sec.
The Multi-Print Display displays a “U.”

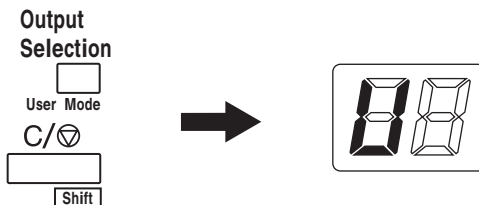

- 2** Press the Exposure Adjustment key (Darker or Lighter) to select the specific function.
- Darker** Pressing the Darker key selects the function in the following order: U → U1
 → U2 → U3 .. → U8.
- Lighter** Pressing the Lighter key selects the function in the following order: U8 → U7
 → U6 → U5 .. → U.

- 3** Press the Exposure Mode key to display d(*).
*: Current setting value



- 4** Press the Exposure Adjustment key (Darker or Lighter) to select the specific setting value.
- Darker** Pressing the Darker key selects the setting value in the following order: d0 →
 d1 ..
- Lighter** Pressing the Lighter key selects the setting value in the following order: d5 →
 d4 d0

- 5** Press the Start key to validate the setting value.

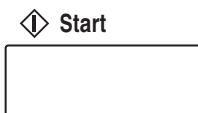

If the Exposure Mode key is pressed, the setting value is not validated and the User mode initial screen (U) appears.

If a new function is to be set, start the procedure over beginning with step 2.

- 6** Press the Clear key.
This lets you leave the User mode, returning back to the ordinary mode.

2. Initial Settings

Settings in Each User Mode Function

U1: Special Print Mode

This function is not available.

U2: Engineering Enhancement Mode

Slight image distortion occurring in the scan direction can be corrected with this function.

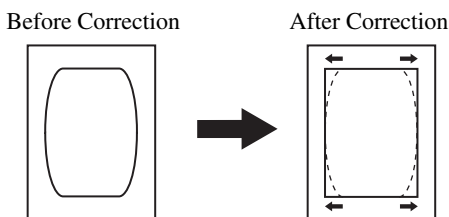

- 1** Select U2 in the User mode.
- 2** Press the Exposure Mode key to display d*.
- 3** Press the Exposure Adjustment key (Darker or Lighter) to select the desired setting value.
- 4** Press the Start key to validate the setting value.

NOTE

*This setting returns to the default value when the Power Switch is turned OFF.
You can register the setting value using with the Job Program. ☞ See p. 2-38.*

Code	Setting Value	Initial Setting
d0	0mm	
d1	0.5mm	
d2	1.0mm	
d3	1.5mm	*
d4	2.0mm	
d5	2.5mm	
d6	3.0mm	
d7	3.5mm	
d8	4.0mm	

U3: Auto Power Save

Time it takes the unit to be automatically set into the Power Save mode can be set.

- 1** Select U3 in the User mode.
- 2** Press the Exposure Mode key to display d*.
- 3** Press the Exposure Adjustment key (Darker or Lighter) to select the desired setting value.
- 4** Press the Start key to validate the setting value.

Code	Setting Value	Initial Setting
d1	Auto Power Save (15 min.)	*
d2	Auto Power Save (30 min.)	
d3	Auto Power Save (60 min.)	

NOTE

For the USA and Canada only:

The Auto Power Save function becomes available for setting only if the Energy Star Kit is mounted on the Scanner.

U4: Paper Feeding Tray Size

The size and direction of the paper loaded in the Paper Feeding Tray can be set with this function.

- 1** Select U4 in the User mode.
- 2** Press the Exposure Mode key to display d*.
- 3** Press the Exposure Adjustment key (Darker or Lighter) to select the desired setting value.
- 4** Press the Start key to validate the setting value.

Code	Setting Value	Initial Setting
d0	Letter (A4) crosswise	*
d1	Letter (A4) lengthwise	
d2	Ledger (A3) lengthwise	
d3	Legal lengthwise	

d3: USA and Canada only

2. Initial Settings

U5: Imprint Position Setting

The Date Print and Character Overlay functions can be set to turn ON or OFF, and the date print position of the Date Print function can be set with this function.

The date print position of Date Print is that set on the screen, regardless of the paper feeding direction in the printer.

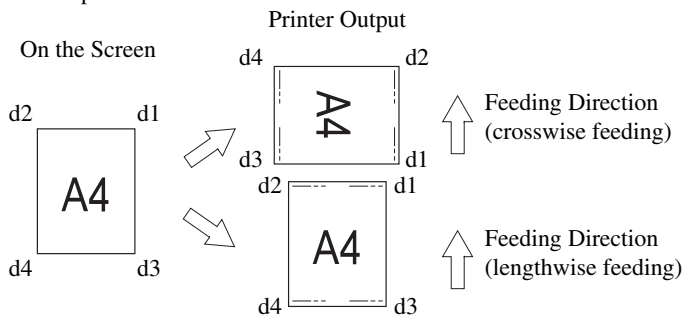

- 1 Select U5 in the User mode.
- 2 Press the Exposure Mode key to display d*.
- 3 Press the Exposure Adjustment key (Darker or Lighter) to select the desired setting value.
- 4 Press the Start key to validate the setting value.

Code	Setting Value	Initial Setting
d0	Turns OFF Date Print and Character Overlay functions	*
d1	Date Print function (upper right)	
d2	Date Print function (lower right)	
d3	Date Print function (upper left)	
d4	Date Print function (lower left)	
d5	Character Overlay function (*)	

(*) A personal computer and an I/F kit are necessary only when the overlay data is transmitted to the scanner.

U6: Year, Month and Date Set Mode

The print pattern for the Date Print function can be set with this function.

- 1 Select U6 in the User mode.
- 2 Press the Exposure Mode key to display d*.
- 3 Press the Exposure Adjustment key (Darker or Lighter) to select the desired setting value.

- 4** Press the Start key to validate the setting value.

Code	Print Pattern	Initial Setting
d0	Year, month, day (2004.05.15)	*
d1	Month day year (05 15 2004)	
d2	Day month year (15 05 2004)	
d3	Month, day Hours:minutes (05.15 13:45)	

Year: 4 digits of dominical year

Month: 2 digits

Day: 2 digits

Hour: 2 digits (24-hour system)

Minutes: 2 digits

U7: Imprint Mode Set

Time-of-day can be corrected for the Date Print function when it becomes wrong.

- 1** Select U7 in the User mode.

- 2** When the Exposure Mode key is pressed, both the Exposure Display and Multi-Print Display light up steadily.

In the initial condition, the year default setting is displayed.

Each time the Darker key is pressed, the lit Exposure Display moves upward to select the currently validated setting mode in the following order: month → day → hours → minutes.

Each time the Lighter key is pressed, on the other hand, the lit Exposure Display moves downward to select a setting mode.

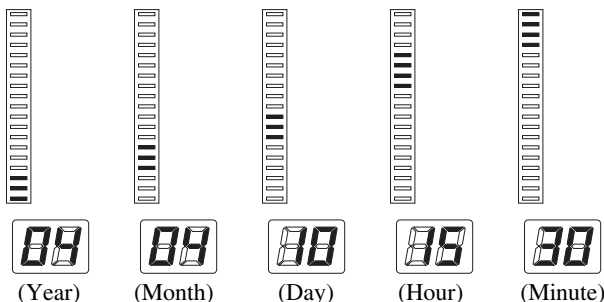

- 3** In each setting mode, press the Multi-Print key to enter the setting value. Each press of the Multi-Print key increases the setting value.

When the value exceeds the maximum setting of the selected mode, it returns to "00" or "01" (month, day).

- 4** When the settings of all modes are completed, press the Start key to validate the time-of-day setting.

2. Initial Settings

U8: Total Scan Counter

The number of scan sequences carried out by the Scanner can be displayed with this function.

- 1** Select U8 in the User mode.
- 2** Press the Start key.
The number of scan sequences so far carried out by the Scanner is displayed.

The following display represents that the scan count is 24,612.



System Settings by the dealer

System Settings	Description	Selection	Initial Setting
Auto reset	Setting changes made to the control panel that are not used within 60 seconds of being input are automatically cancelled and the system reverts back to the original settings.	Enabled Disabled	* (200V) * (120V)
Auto Power Save ON/OFF	Sets the unit to enable or disable the Auto Power Save mode. * For USA and Canada (120V area), the Auto Power Save mode becomes available only if the Energy Star Kit is mounted on the Scanner.	Enabled Disabled	* (200V) * (120V)
Printer Heater OFF (PR mode only)	Turns the Printer's heater OFF if the system is left idle for a specific period of time. * Priority is given to the Power Save mode, if Power Save has been set.	Disabled 30 min. 60 min.	*
Auto Projection Lamp OFF	Turns the Scanner's Projection Lamp OFF if the system is left idle for a specified period of time. * Priority is given to the Power Save mode, if Power Save has been set.	Disabled 30 min. 60 min.	*
Fine mode contrast select	Applies the following functions as required: Contrast Emphasis: applied when film contains text that is poorly contrasted against its background making it difficult to read. Outline Emphasis: applied when film contains blurred black and white images.	Contrast Emphasis Outline Emphasis	*

2. Initial Settings

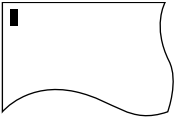
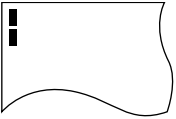
System Settings	Description	Selection	Initial Setting
Auto Skew Correction Retain	Determines whether or not to retain the original (uncorrected) skew of a screen image after the print has been made.	Retained Not retained	*
Unit ID Printing (PR mode only)	When two scanners are connected to one printer, this function leaves an identification marker on the print so that the scanner used for the job can be determined after printing. <div style="display: flex; justify-content: space-around; align-items: center;"> <div style="text-align: center;"> <p>Pattern 1</p>  <p>Paper</p> </div> <div style="text-align: center;"> <p>Pattern 2</p>  <p>Paper</p> </div> </div>	Disabled Pattern 1 Pattern 2	*
Cycle print mode (PR mode only)	This function automatically scans the next image following a preset period of time (the period can be set by an authorized dealer). Images are set by the user onto the Carrier Glass in between cycles.	Enabled Disabled	*
Paper Size of Paper Feeding Tray (PR mode only)	Determines the desired paper size and the orientation from the Paper Feeding Tray of the printer.	Same as the setting for U4 of the User Mode. See p. 7-9.	
Contrast setting	To view subtle images with standard ranges of density clearly: Light (-1 - -7) To bring out the darker and lighter ranges of an image: Dark (+1 - +7)	Lighter Normal Darker	*

2. Initial Settings

System Settings	Description	Selection	Initial Setting
The print function at the time of Toner Empty or Toner Cartridge Life detection (PR mode only)	<p>After a toner empty condition or toner cartridge life is detected, this function allows you to select either to stop printing or continue printing.</p> <p>* Toner cartridge life detection is only connected with MSP3500. (When selected the enable print after the Toner Cartridge life fulfillment, while depress the Start key, LED displays the toner cartridge life fulfillment “TE”.)</p>	Empty >> Disable Print Life >> Disable Print Empty >> Enable Print Life >> Disable Print Empty >> Enable Print Life >> Enable Print	*
Auto Film Format Select print function (PR mode only)	The Auto Format Select Print Function is enable or disable through the control panel.	Enable Disable	* (200V) * (120V)
90 degree rotation setting	Enables the prism to rotate the screen image 90 degrees.	Enable Disable	*
Automatic paper source switching (PR mode only)	<p>Allows you to specify the paper source when Letter or A4 size paper is loaded in Lengthwise or Crosswise orientations into the both paper feeding tray and paper feeding cassette.</p> <p>Auto switching: Printing continues by automatically switching to the remaining paper source after paper in the specified paper source runs out.</p> <p>Disabling Auto Switching: A paper empty mode occurs and printing ceases after paper in the specified paper source runs out. The paper source must be refilled or the paper source must be switched by pressing the Output Selection Key in order to resume printing.</p>	Auto switching Disabling Auto Switching	*

* To change any of the system settings described above, contact the authorized dealer.

For Key Operator's Use

When you need to call for service, the Key Operator should be prepared to provide the following information to the authorized Dealer.

1. Your Company Name, Address, Telephone Number, Department Name, Floor Number, Unit Location, etc.
2. Model Name, Serial Number, Condition or System(s) Indication(s) on the Display, etc.

For your reference purpose.

Model Name	MS6000 MKII	Serial No. _____
	Printer (MSP 3500)	Serial No. _____
	Printer (MSP 3000)	Serial No. _____
Attached Accessories		Serial No. _____
		Serial No. _____
		Serial No. _____
		Serial No. _____
		Serial No. _____
Installation Date		
Authorized Dealer's Name TEL. No. Address		

