



iea wind

IEA Wind Task 25

Design and operation of power systems with large amounts of wind power

Final summary report, IEA WIND Task
25, Phase four 2015-2017

Hannele Holttinen et al. |

Design and operation of power systems with large amounts of wind power

Final summary report, IEA WIND Task 25, Phase four 2015-2017

Hannele Holttinen, Juha Kiviluoma VTT; Thomas Levy Natural Resources Canada; Liu Jun SGERI, China; Peter Borre Eriksen, Antje Ortho Energinet, Denmark; Nicolaos Cutululis DTU, Denmark; Vera Silva, Emmanuel Neau EDF R&D, France; Jan Dobschinski Fraunhofer IEE, Germany; Serafin von Roon FfE, Germany; Jody Dillon Energy-Reform, Ireland; Damian Flynn UCD, Ireland; Enrico Maria Carlini Terna, Italy; Ryuya Tanabe CRIEPI, Japan; Yoh Yasuda Kyoto University, Japan; Miguel Ramirez INEEL, Mexico; Jose Rueda Torres TUDelft, NL; Til Kristian Vrana SINTEF, Norway; Magnus Korpås NTNU, Norway; Ana Estanqueiro, Antonio Couto LNEG, Portugal; Emilio Gomez Lazaro University Castilla La Mancha, Spain; Lennart Söder KTH, Sweden; Danny Pudjianto, Goran Strbac Imperial College, UK; Bri-Mathias Hodge NREL, USA; J Charles Smith ESIG, USA; Debbie Lew GE, USA; Daniel Fraile Wind Europe

ISBN 978-951-38-8683-7

VTT Technology 350

ISSN-L 2242-1211

ISSN 2242-122X (Online)

DOI: 10.32040/2242-122X.2019.T350

Copyright © VTT 2019

JULKAISIJA – PUBLISHER

VTT

PL 1000

02044 VTT

Puh. 020 722 111

<https://www.vtt.fi>

VTT

P.O. Box 1000

FI-02044 VTT, Finland

Tel. +358 20 722 111

<https://www.vttresearch.com>

Preface

A research and development (R&D) task on the Design and Operation of Power Systems with Large Amounts of Wind Power was formed in 2006 as IEA Wind Task 25¹. The aim of this R&D task is to collect and share information on the experiences gained and the studies made on power system impacts of wind power and to review methodologies, tools, and data used. The following countries and institutes have been involved in the collaboration:

- Canada: Hydro Québec's Research Institute (IREQ)
- China: State Grid Energy Research Institute (SGERI)
- Denmark: Technical University of Denmark (DTU); Energinet.dk
- European Wind Energy Association (WindEurope)
- Finland (operating agent): Technical Research Centre of Finland (VTT)
- Germany: Fraunhofer Institute for Wind Energy and Energy System Technology (Fraunhofer-IWES, now Fraunhofer IEE); Research Centre for Energy Economics (FfE)
- Ireland: Sustainable Energy Authority of Ireland (SEIA); Energy Reform, University College Dublin (UCD)
- Italy: Terna
- Japan: University of Kyoto; Central Research Institute of Electric Power Industry (CRIEPI); University of Social Sciences Tokyo
- Norway: Foundation for Scientific and Industrial Research (SINTEF)
- Netherlands: Delft University of Technology (TUDelft); TenneT
- Portugal: National Laboratory on Energy and Geology (LNEG); Institute for Systems and Computer Engineering, Technology, and Science (INESC-TEC)
- Spain: University of Castilla La Mancha
- Sweden: Royal Institute of Technology (KTH)
- United Kingdom: Centre for Sustainable Electricity and Distributed Generation (Imperial College London and Strathclyde University)

¹ IEA WIND is a Technology Collaboration Programme (TCP) for Co-operation in the Research, Development, and Deployment of Wind Turbine Systems within the International Energy Agency (IEA)

- United States: National Renewable Energy Laboratory (NREL); Utility Variable-Generation Integration Group (UVIG – now Energy System Integration Group ESIG); U.S. Department of Energy (DOE).

IEA Wind Task 25 produced a report in 2007 on the state-of-the-art knowledge and results on wind integration that had been gathered so far, published in the VTT Working Papers series. Summary reports of three subsequent phases have also been published by VTT: 2009 (VTT Research Notes 2493), 2013 (VTT Technology T75) and 2016 (VTT Technology T268). These reports presented summaries of selected, recently finished studies. All of these reports are available on the IEA Wind Task 25 website: <https://community.ieawind.org/task25/home>. In addition, IEA Wind Task 25 developed guidelines on the recommended methodologies when estimating the system impacts and costs of wind power integration; this was published in 2013 as RP16 of IEA Wind with an update to include also solar PV in 2018. The recommended practices reports are available in the website <https://community.ieawind.org/publications/rp>.

This report summarises the results of the fourth three-year phase. The work continues with a fifth three-year period (2018–2020).

December 2018, Authors

Contents

Preface	3
List of acronyms	8
Executive summary	11
1. Introduction	15
2. The inputs: variability and uncertainty of power system wide wind power	19
2.1 Variability	19
2.1.1 Variability from actual wind energy generation.....	19
2.1.2 Extreme ramps in storms	21
2.1.3 Smoothing impact and metric for system size and wind dispersion 24	
2.1.4 Variability from simulated wind energy generation.....	25
2.1.5 Wind and solar complementarity	30
2.2 Uncertainty	31
2.2.1 Forecast errors of wind energy from actual data.....	31
2.2.2 Analysis of largest forecast errors	32
2.2.3 Ramp forecasting	35
2.2.4 Forecast error data simulations.....	36
3. Planning grid adequacy	37
3.1 European grid scenarios for high shares of wind power.....	37
3.2 US Eastern interconnect.....	38
3.3 Canadian grid for 20–35% share of wind	39
3.4 Overplanting wind capacity to transmission line	40
3.5 Offshore grids	41
4. Ensuring long term reliability and security of supply	46
4.1 Estimating capacity value of wind power	46
4.1.1 Results from national studies - Canada	46
4.1.2 Multiple year data sets needed for capacity value estimate.....	47
4.1.3 Multi area methods for capacity value	49
4.2 Capacity adequacy concerns from low market prices	50
4.2.1 Revenue sufficiency from future electricity market prices in high shares of wind and solar	50
4.2.2 Addressing capacity adequacy in energy only markets with scarcity pricing.....	51
5. Guaranteeing short term system reliability	53
5.1 Stability and grid security.....	53
5.1.1 Experience on stability issues with variable generation	53
5.1.2 Studies for stability issues	54

5.1.3	Studies on frequency stability impacts of wind power	55
5.1.4	Impact of HVDC connections on stability	56
5.2	Wind power plant capabilities for stability support	58
5.2.1	Wind power plants and frequency stability	59
5.2.2	New services for stability support	62
5.3	Operating reserves	63
5.3.1	Experience on operating reserves in regions with high shares of wind power	64
5.3.2	Estimating requirements for operating reserves	66
6.	Maximizing the value of wind power in operations	72
6.1	Curtailments	72
6.1.1	Curtailments in Europe	73
6.1.2	Curtailments in US	76
6.1.3	Curtailments in China	77
6.2	Using wind power plants for frequency support services	77
6.2.1	Primary frequency response	77
6.2.2	Regulation/AGC/Secondary Response	79
6.2.3	Tertiary/balancing services with 10...30 min response time	81
6.2.4	Barriers for integrating wind power to markets	83
6.2.5	Increased value for wind power from markets	84
6.3	Operational practices: Market design	84
6.3.1	Market design features to enable wind power integration	85
6.3.2	New market products for high share wind systems	86
6.4	Operational Practices: grid	88
6.4.1	Using forecasts for grid operation	88
6.4.2	Dynamic line rating	89
6.5	Flexibilities	93
6.5.1	Co-locational storage at wind power plant	93
6.5.2	Flexibility from hydro power with storage	95
6.5.3	Flexibility from power and heat sector coupling	99
6.5.4	Flexibility through use of transmission and interconnectors to neighbouring area	100
6.5.5	Flexibility from demand side measures	100
6.5.6	Comparing flexibility options	101
6.5.7	Value of flexibility in reducing the system integration cost of wind power	104
7.	Pushing the limits: towards 100% shares of renewables	106
7.1	Operating the Danish power system without central power plants	106
7.2	100% renewable electricity studies in Sweden	108
7.3	Global 100% renewable energy scenario and implications for Nordic countries	109
7.4	European wide 60% renewable study	110

8. Conclusions	113
Acknowledgements	115
References	116

Appendices

Appendix A: Planned work for years 2018–20

Abstract

List of acronyms

AESO	Alberta Electric System Operator
AGC	Automatic Governor Control
ANN	Artificial Neural Networks
BPA	Bonneville Power Administration
CAISO	California Independent System Operator
CfDs	Contract of Differences
CHP	Combined Heat and Power
DLR	Dynamic Line Rating
DSO	Distribution System Operator
DWD	Deutscher Wetterdienst, German Weather Service
ECMWF	European Centre for Medium-Range Weather Forecasts
EESS	Electrochemical Energy Storage Systems
ENTSO-E	European System Operators
EPS	Ensemble Prediction Systems
ERCOT	Electric Reliability Council of Texas
ERGIS	Eastern Renewable Generation Integration Study
EUE	Expected Unserved Energy
FCR	Frequency Containment Reserve (primary control in Europe)
FERC	Federal Energy Regulatory Commission
FFR	Fast Frequency Response
FRRa	automatic Frequency Restoration Reserve (secondary control in Europe)

FRRm	manually activated Frequency Restoration Reserve (tertiary control in Europe)
HVAC	High Voltage Alternating Current
HVDC	High Voltage Direct Current
IESO	Independent Electricity System Operator
KNN	K-Nearest Neighbour
KPI	Key Performance Indicators
LCOE	Levelized Cost of Energy
LOLE	Loss of Load Expectation
LOLH	Loss of Load Hours
LOLP	Loss of Load Probability
LORP	Loss of Reserve capacity Probability
MAE	Mean Absolute Error
MAF	Mid-term Adequacy Forecast
MERRA-2	Modern-Era Retrospective analysis for Research and Applications, Version 2
MISO	Midcontinent Independent System Operator, Inc.
MOS	Model output statistics
MT	Multi-terminal
nadir	the point at which frequency is arrested - the frequency nadir
NERC	North American Electric Reliability Council
NWP	Numerical Weather Prediction
NYISO	New York Independent System Operator, Inc.
OCGT	Open-cycle Gas Turbines
OCTs	Operational Capability Tests
OHL	Over Head Line
ORDC	Operating Reserve Demand Curve
PCWIS	Pan Canadian Wind Integration Study
PFR	Primary Frequency Response
POD	Power Oscillation Damping
PSCo	Public Service Company of Colorado

PSS	Power System Stabiliser
PV	PhotoVoltaic (solar electricity)
REQ	Equivalent System Radius
RES	Renewable Energy Source
RMSE	Root-mean-square-error
ROCOF	Rate of Change of Frequency
RTO	Regional Transmission Operator
SG	Synchronous Generators
SNSP	System Non Synchronous Penetration
SP	Synchronising Power
SRL	Sekundärregelleistung = secondary control power
TSO	Transmission System Operator
TYNDP	Ten Year Network Development Plan
VOLL	Value of Lost Load
VRE	Variable Renewable Energy
VSC	Voltage Source Converter
WPP	Wind Power Plant
WRF	Meso scale numerical weather prediction model

Executive summary

This report summarises recent findings on wind integration from the 17 countries and Wind Europe participating in the International Energy Agency (IEA) Wind collaboration research Task 25 from 2015–2017. Both real experiences and studies are reported. Many wind integration studies incorporate solar energy, and most of the results discussed here are valid for other variable renewables in addition to wind.

The participating countries report increasing shares of wind on average: 43% annual energy in Denmark, about 25% in Ireland, Portugal and in the province of Prince Edward Island in Canada, and more than 30% in Iowa, South Dakota, Kansas, and Oklahoma in the USA. During certain hours more than 100% instantaneous share has been achieved in Denmark and Portugal, more than 80% in Italy and Germany, and the island power system of Ireland has seen 79% of demand, against an allowable 65% share from non-synchronous sources.

The national case studies address several impacts of wind power on electric power systems. In this report, they are grouped under long-term planning issues and short-term operational impacts. Long-term planning issues include grid planning and capacity adequacy. Short-term operational impacts include reliability, stability, reserves, and maximising the value of wind in operational timescales (balancing related issues). The first section presents the variability and uncertainty of power system-wide wind power, and the last section presents recent wind integration studies for higher shares of wind power. The appendix provides a summary of ongoing research in the national projects contributing to Task 25 for 2018–2020.

Variability and uncertainty of wind power – an important input

The characteristics of variability and uncertainty in wind power are presented from experiences with measured data from large-scale wind power production and forecasting. There is a significant geographic smoothing effect in both the variability and uncertainty of wind power when looking at power system-wide areas. Failure to capture this smoothing effect will affect the estimates for wind power impacts on power systems.

The smoothing effect is shown in the measured extreme variations and extreme forecast errors, which are relatively smaller for larger geographic areas. Variability is also lower for shorter timescales. European wide data from 2017 shows that there was only one event, lasting 2 hours, when total wind generation was below 5% of installed capacity, and the maximum duration of less than 10% of capacity was 38 hours.

Regarding day-ahead forecasts, improvements continue to be recorded: about 20% improvement in mean absolute error in 5 years, leading to values for 24-hour-ahead forecasts of approximately 2% of the installed total wind power capacity in Spain.

Analyses of extreme variability and forecast error events show that they often occur during storms. Analyses of weather situations and ramps help the extreme

situations and ramp forecasting (Germany, Portugal). Wind and solar show good complementarity to reduce the aggregated output variability (Portugal). Weather model data is improving in its ability to represent wind energy time series (Sweden) and tools for simulating large scale wind power generation are evolving (Denmark).

Wind power in long term planning for grid and generation adequacy

The grid reinforcement needed for wind power is very dependent on where the wind power plants are located relative to load and existing grid infrastructure, and it is expected that results will vary significantly from one country to another. As in most cases transmission lines are used for multiple purposes, the costs of grid reinforcements is not usually allocated to wind power.

The European-wide study e-Highways found the most beneficial transmission build out for a future high renewable share power system to be mostly on the North-South corridors; an extra high voltage super grid layout was not found to be cost effective in this European case. Overplanting wind power capacity to transmission lines as a means to improve usage of grid investment showed improved benefits for offshore wind in the UK. The flexibility needs being mitigated through transmission to reduce curtailments of wind power and to access flexibility from hydropower has also been addressed in several studies.

Wind power's contribution to a system's generation capacity adequacy is its capacity value. In most countries, this is not a critical question in the starting phase of wind power deployment; however, there is already experience from conventional power plants with insufficient revenue withdrawing from the market due to reduced operating times and full load hours. This subsequent retirement of generation will raise the question of resource (or generation) adequacy in a power system. Wind power will provide more capacity and thus add to the reliability of the power system. However, the benefits of added capacity vary depending on how much wind resource is available during times of peak loads, and the capacity value of wind power will decrease with an increasing share of wind power in the system.

System adequacy for future high penetration wind and solar systems highlights a need for multi area assessment in adequacy estimates (Sweden, ENTSO-E). Recent studies point out the importance of many years of wind and load data to get robust results for wind power capacity value; 10 to 30 years in North Europe (Finland, France). System adequacy is also gaining interest in market settings. Studies in Finland and the USA show that in addition to low marginal cost wind and solar, over-capacity results in low energy prices. Means to provide correct economic signals from energy only markets through scarcity pricing have been tested in Texas.

Impacts of wind power on short-term reliability

With larger shares of wind power it will become increasingly more important to study power system dynamics in wind integration studies. Wind generation, by its mere presence, does not necessarily worsen the stability of a system, but it does change its characteristics because modern wind turbines are connected via power

electronic interfaces. Wind power plants can offer a promising option for defence against short-term voltage and frequency instability, and system capabilities can be enhanced through intelligent coordination of the controllers of the power electronic converters. In Quebec, wind power plants supported the power system recovering from a frequency event.

Integration studies are increasingly focused on examining the possibilities for wind power plants to support the grid. Frequency stability was first studied in smaller systems such as Ireland, but it is increasingly being studied for larger areas that have higher shares of wind power (USA, Texas, Nordic countries, Mexico, Netherlands). Grid code capabilities for wind power plants are evolving and also new capabilities like power oscillations damping are being investigated (Denmark).

Denmark recently passed a landmark in their system, operating the system with a greater than 100% wind share without any large power plants online, relying on HVDC links and local smaller power plants for frequency and voltage control.

The impact of wind power on short-term balancing and frequency control has been the focus of many integration studies for decades. The reserves are operated according to total system net imbalances for generation and demand, not for each individual source of imbalance. A large range of results for estimates of increases in reserve requirements have been reported in previous Task 25 reports. Impact of forecast errors on balancing needs will reduce considerably for larger balancing areas, and shorter time scales (Finland). New ways to allocate operational reserves are reported from Texas, Germany and Japan. Changes in operational practices, like sharing balancing and moving to shorter dispatching, has a strong declining impact on operational reserves, even with an increasing trend of wind power deployment (Germany, Texas). In Texas the benefits of fast response of wind power plants show a decreasing trend in the need for fast frequency reserves.

Maximising the value of wind power in operation

The value of wind power is maximised when there is no need to curtail any available wind power and when the impact on other power plants in the operational timescale is minimised.

Experiences in wind power curtailment show that curtailments do not occur in smaller shares of 5–10% of yearly electricity consumption if there are no severe transmission bottlenecks and wind power is dispatched first among the low marginal cost generation. However, in some countries substantial curtailments (10–20% of wind generation) started occurring at lower shares of wind. The mitigation efforts regarding transmission expansion in these countries have resulted in a reduction in curtailment rates with increasing wind power. Curtailments are seen as a sign of limits to wind integration in integration studies, and as a sign where the use of existing flexibility is not optimal (China, Japan). European countries still have limited amounts of curtailment even if the share of wind is considerable because of the large degree of interconnectedness between most neighbouring countries. Transmission reinforcement delays still impact some countries, like Germany. Ireland has shown improvements in reducing its system constraints to require lower curtailments due to network build out, enhanced power plant monitoring and the

introduction of on-line stability assessment tools, but increased wind capacity can result in stability limits being imposed at certain times.

Balancing costs have traditionally been the main issue that many integration studies try to estimate. It is becoming less of an issue in countries where experiences in wind integration are accumulating. There is some recorded experience of actual balancing costs decreasing despite growing shares of wind power. In Germany this was due to the benefits of sharing balancing between system operators and in Texas from moving closer to real time dispatch. Experience is building also from Colorado, California, Quebec, Ireland, Spain, and Denmark showing that wind power can participate in frequency support services. Market operation of wind power plants is still evolving.

Measures to enhance flexibility with high shares of wind power include operational practices and markets, demand-side flexibility, and storage. Electricity markets that have cross-border trades of intraday and balancing resources and emerging ancillary services markets are considered positive developments for future large shares of wind power. Improvements in the market operations have been highlighted from studies in both Europe and the USA. Methods to improve the value of wind energy in the markets have been shown in Portugal. Ireland has introduced a wide number of new services to increase system flexibility, in the form of synchronous inertia, fast frequency, ramping margin, dynamic reactive power and active power response following network faults.

Enhancing the operation of the transmission grid includes many different methods, including: dynamic line ratings (Italy, Portugal), use of power flow control (Ireland), and forecasts (France, Germany).

Enhancing the use of hydropower storage to balance larger systems shows positive results from Norway, pointing also to the need for more detailed simulation tools. Electricity storage is seeing initial applications with the Italian system operator in reducing congestion in locations with limited transmission capacity, as well as providing frequency support.

Decreasing curtailments through flexibility of transmission, demand side management, and power and heat coupling has been shown in China. Comparing the value of different flexibility options in Northern European scenarios shows that electricity storage needs to cost below 100 €/kWh in larger power to provide a cost effective source of flexibility. Electric battery storage and pumped hydro storage will likely also take on different roles, short and long-term storage respectively, in future systems.

Integration studies for power systems that have close to 100% renewables are pushing the limits of how much variable generation can be integrated. Energy system coupling and use of power to X storages are seen in these studies. This work is ongoing, with more detailed modelling tools needed in the future to understand the implications in simulation before they can be transitioned into real system operations.

1. Introduction

There is an increasing amount of practical experience from wind integration. In 2016 wind energy covered 10.4% of EU power demand. This share increased to 11.6% in 2017. In some days, wind power covered more than 100% of some Member State's electricity demand (Denmark, Portugal), and high shares were recorded also in Ireland, Spain and Germany. The yearly wind shares in Europe are presented in Figure 1 and in the U.S. in Figure 2.

It is also interesting to see the instant high shares of wind, as presented in Table 1 and Figure 4. The average share of wind energy does not tell all about the challenges of integrating wind power to power systems, we also use a metric where the installed wind capacity is presented as the share of minimum load and export capability in Figure 3.

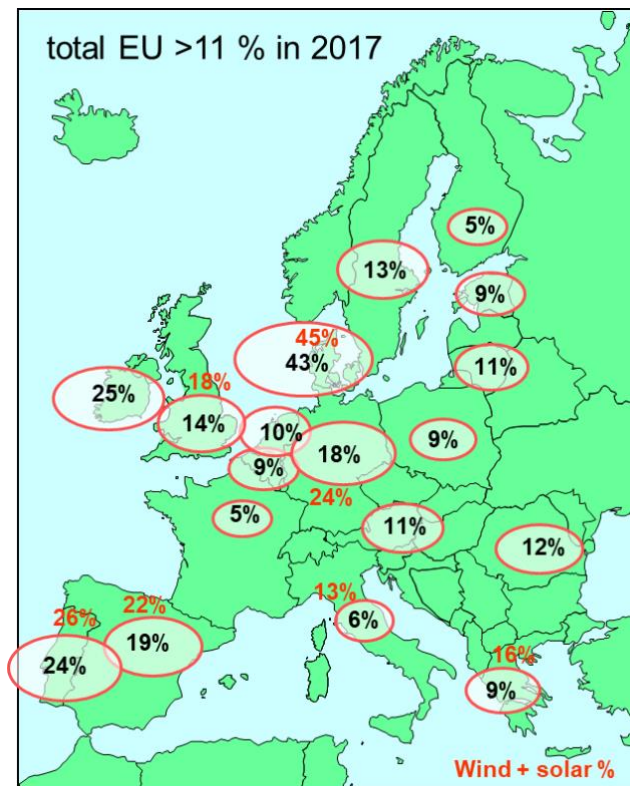

Figure 1. Share of wind generated electricity from total electricity consumption in Europe in 2017 (Source of data WindEurope statistics). The variable generation shares (wind+solar PV) are shown in red.

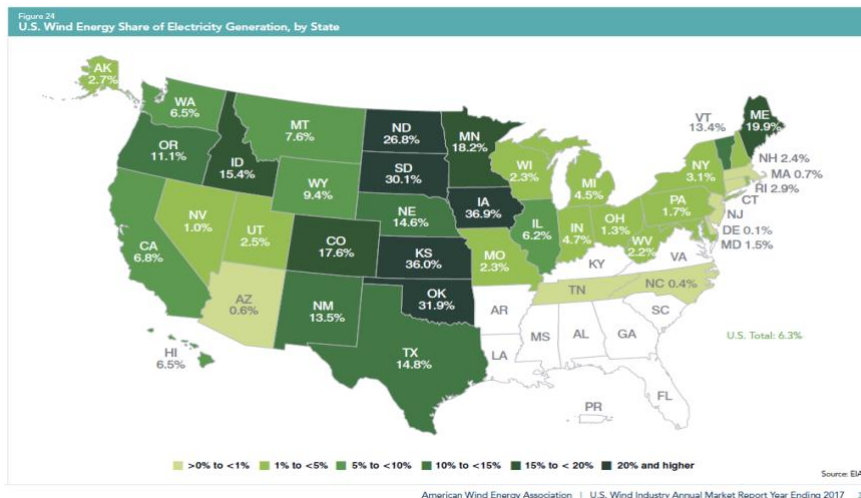

Figure 2. Share of wind generated electricity from total electricity consumption in the U.S. in 2017. Four states had more than 30% average share of wind energy in 2017 (Source: AWEA).

Table 1. Average and maximum wind shares recorded in 2017.

Country	Wind GW	Wind TWh/a	solar GW	solar TWh/a	Peak load GW	Min load GW	Demand TWh/a	Inter-connectors max capacity GW	max in an hour	max during a day	max during a month	Wind average share of energy	wind+PV average share of energy	Wind share of peak load	Wind share of min load + max export capability
Denmark	5,5	14,8	1,0	1,0	6,2	1,9	34,1	6,3	139%	109%	53%	43,4%	46,3%	89,0%	67,3%
Island of Ireland	4,5	9,3			6,3	2,4	35,0	1,0	79%			26,5%	26,5%	71,0%	131,5%
Ireland	3,4	7,4			5,0	2,0	30,0	1,8				24,8%	24,8%	67,4%	88,6%
Portugal	5,3	12,3	0,6	1,0	8,8	3,3	51,3	3,8	110%	82%	34%	24,0%	26,0%	60,4%	74,8%
Spain	22,8	47,5	6,7	13,3	41,4	18,5	267,9	7,6				17,7%	22,7%	55,1%	87,4%
Germany	50,0	106,6	42,0	40,0	80,6	35,0	602,3	13,8	81%	71%	34%	17,7%	24,3%	62,0%	102,5%
UK	19,8	49,6	12,8	11,5	50,0	18,1	336,0	4,0	52%	38%	23%	14,8%	18,2%	39,7%	89,8%
Sweden	6,6	17,6	0,2	0,7	26,6	8,9	140,0	10,0	39%	32%	17%	12,6%	13,0%	24,9%	35,0%
Italy	9,8	17,5	19,7	24,8	56,6	19,0	320,4	3,6	89%	63%	39%	5,5%	13,2%	17,3%	43,4%

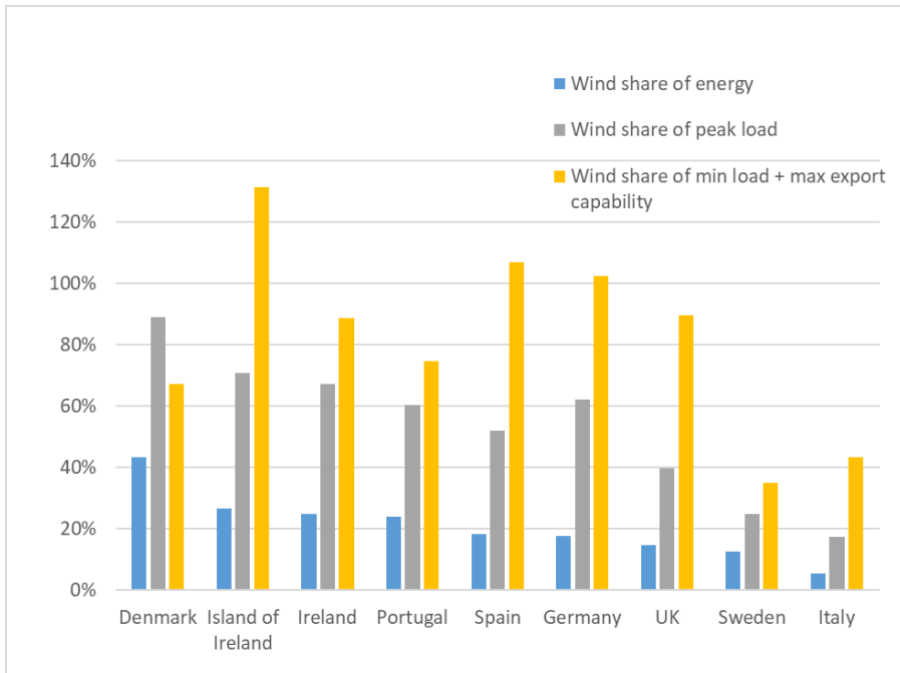

Figure 3. Wind share of consumed electric energy (blue), peak load capacity (grey) and during a critical low load situation (wind installed capacity relative to minimum load and maximum export capacity). (Source: Table 1).

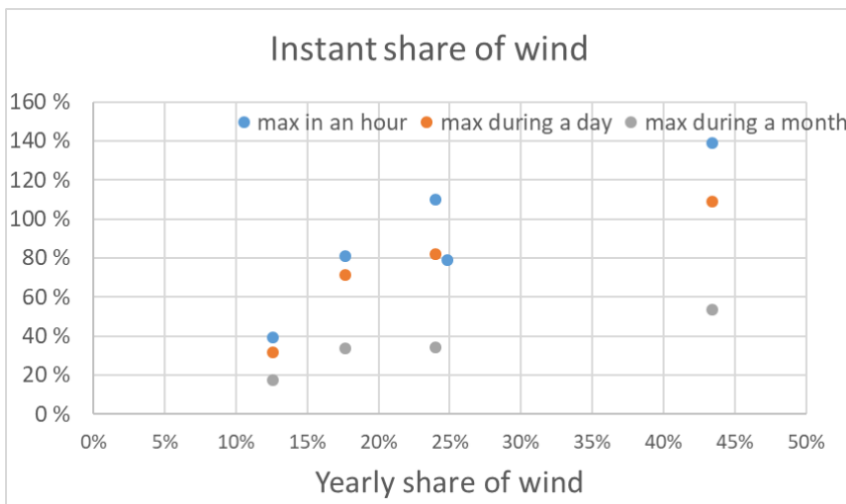

Figure 4. Wind energy share in one hour, day and month, relative to the average share over a year. Recorded values from Sweden, Germany, Portugal, Ireland and Denmark (see also Table 1).

Wind power production introduces additional variability and uncertainty into the operation of the power system, over and above that which is contributed by load and other generation technologies. To meet this challenge, there is a need for more flexibility in the power system. The increased need for flexibility required depends on how much wind power is embedded in the system as well as how much flexibility already exists in the power system. Because system impact studies are often the first steps taken towards defining feasible wind penetration targets within each country or power system control area, it is important that commonly accepted standard methodologies related to these issues are applied (see Recommended Practices for Wind and Solar Integration Studies Holttinen (Ed.) 2018) The summary reports that gather findings from experience and study results give valuable information on the challenges, benefits and mitigation possibilities for wind integration (Holttinen et al., 2007; 2009; 2012; 2016a), of which this report is an update with more recent results.

The case study results are summarised in four sections: first, Section 2 provides updated information on the variability and uncertainty of large-scale wind power. Sections 3 and 4 address the long term planning issues with wind power: grid planning and capacity adequacy. Sections 5 and 6 address the operational impacts: short term reliability (stability and reserves) and maximising the value in operational time-scales (balancing related issues). Section 7 summarises recent wind integration studies for higher shares of wind power and Section 8 concludes. Appendix provides a summary of on-going research in the national projects contributing to Task 25.

2. The inputs: variability and uncertainty of power system wide wind power

This chapter covers variability and predictability of wind power. Data for aggregated wind power generation covering larger, system wide and balancing area wide regions is an important input to integration studies. Variability in wind power generation causes changes to the operation of conventional generation fleet. Uncertainty leads to changes in shorter time scales (i.e., ramping) and can necessitate changes in operational practices to enable shorter response time from the flexible generation plants taking part in balancing.

As will be more elaborated in following sections, wind is only one source of variability and uncertainty in the electric system. Electric demand, unscheduled equipment unavailability, run-of-river hydro or solar PV generation will add their share to the total aggregated variability in the power system. An operator must react to the net system variability and uncertainty and simply adding individually established impacts will lead to inefficient management of the electric system.

There is a significant smoothing effect in both variability and uncertainty of wind power when looking at power system wide areas. Inability to capture this smoothing effect will result in poor estimates for power system impacts of wind power. The uncertainty in future wind power production will further be reduced as more accurate forecasting methods are developed and operational practices evolve towards faster decisions with better forecast accuracy.

2.1 Variability

2.1.1 Variability from actual wind energy generation

Variability of actual wind energy generation in European Union has been analysed by WindEurope with their Daily Wind Power Number Platform web-tool <https://windeurope.org/about-wind/daily-wind/>. Energy generation and demand profiles across Europe and share of wind in different countries are published every day from day before information provided via the ENTSO-E transparency platform, combined with WindEurope annual installations capacity (Figure 5).

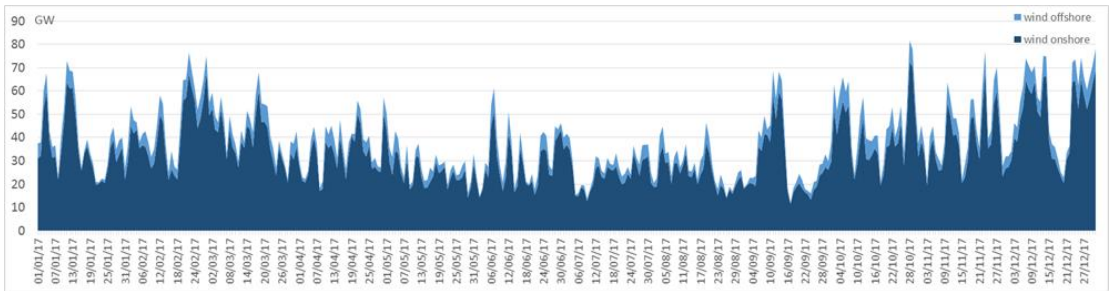

Figure 5. Daily wind generation in 2017 in European Union (Source: WindEurope).

In 2017, the minimum was registered on June 2nd at 10.00 hours, 7.8 GW (5% of installed wind capacity) and maximum on October 28th at 20.00, 88 GW (52% of installed wind capacity). The capacity factor was on average 22.3%. Offshore wind generation is more evenly distributed across a larger spectrum of values, with values generally larger than for onshore (Figure 6). Since offshore capacity is much smaller and more concentrated mainly in North Sea, the minimum was 0% and maximum 75% of the installed capacity, compared to onshore wind with values between 10 and 30%.

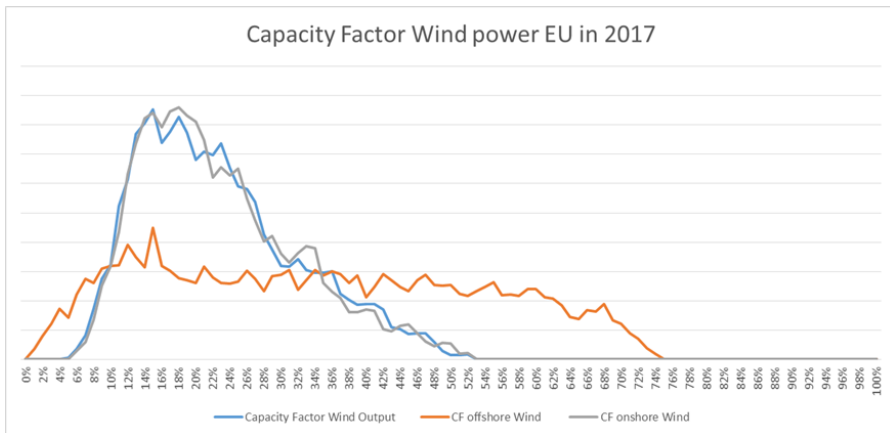

Figure 6. Probability curves for capacity factors based on hourly wind generation data.

Periods of low wind generation

For larger areas the wind always blows somewhere. This has been proved by the hourly data available for Europe. However, there can be low wind periods when the generation is much lower than average. Periods of low wind for European Union were analysed by WindEurope for different thresholds of low wind (Figure 7). The installed capacity used for this analysis was from end of 2016, this may cause a

slight overestimation of the capacity factors, as the installed capacity end of December was 10% higher than beginning of January.

- There was only one event, during 2 hours when total wind generation was below 5% of installed capacity.
- During 17 hours, wind generation was below 6% of installed capacity; this took place during individual events shorter than 5 hours.
- Wind load was below 10% of its installed capacity during 430 hours. Most of the events lasted less than 10 hours. The longest one lasted for 38 hours.

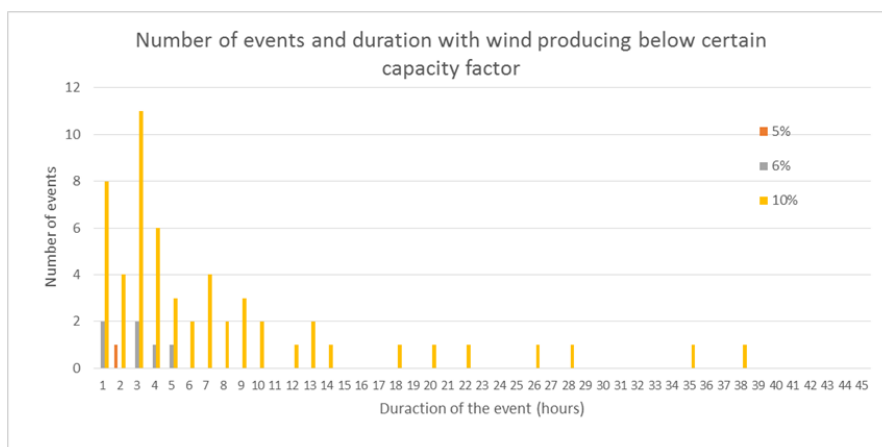

Figure 7. Number of events and duration with wind producing below certain capacity factor.

2.1.2 Extreme ramps in storms

Experience of extreme ramps in storms have been recorded in

- Germany: largest downward ramp 12% of installed capacity in an hour during a storm 14th Feb, 2014. Largest ramps recorded from 3 years of data: -5.8% to +5.1% of installed capacity within 15 minutes, -12.5% to +11.9% within 1 hour and -38% to +45% within 5 hours.
- Portugal: The most severe wind power ramps observed have been -10.7% to +6.8% of installed capacity within 15 minutes, -19.2% to +24.6% within 1 hour and -50.6% to +63.6% within 5 hours
- Denmark: System operator Energinet reported of the largest storm event in Oct 2013 when wind power decreased from 3000 to 1000 MW in less than 2 hours (25% of capacity in an hour and 6% of capacity in 15 minutes)
- Spain: Largest hourly ramps in 2017 +8.4% and -9.4% of installed capacity – for 15 min ramps +4.7% and -4.9% of installed capacity.

For Germany, the extreme ramps have been analysed based on more than 3 years of data (28575 MW of wind power in 01/2012 to 38104 MW in 04/2015). To overcome the problem that the maximum observed values could be caused by erroneous data the 0.01% and the 99.99% quantiles of the distributions has been calculated: -3.8% and +3.4% for 15 minutes, -10.4% and +10.4% for 1 hour and -33.7% and 38% for 5 hours (Figure 8). The largest ramps and forecast errors occurred during the 130 storm events recorded during that time Figure 8 and Table 2.

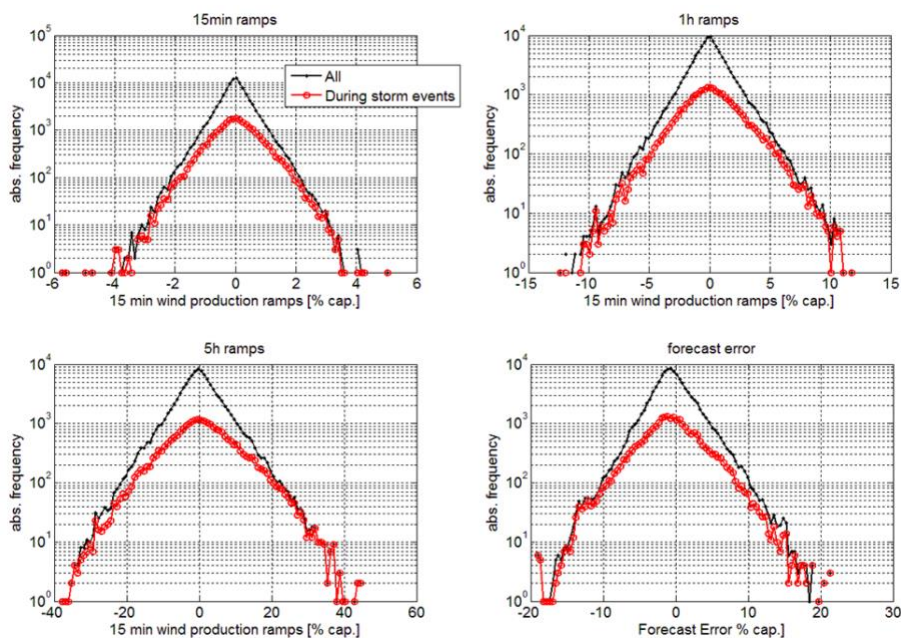

Figure 8. Wind power ramping analysis for Germany. Frequency distributions of 15min, 1h and 5h ramps and forecast errors during the time period 01/2012 to 04/2015 (black) and during storm events within this time period (Source: Fraunhofer IEE).

An additional evaluation of the 50 highest positive and negative ramps and forecast errors is shown in Figure 9. More than 60% of these events occurred during storm events – for 5-hour ramps all 50 largest ramps were during storms.

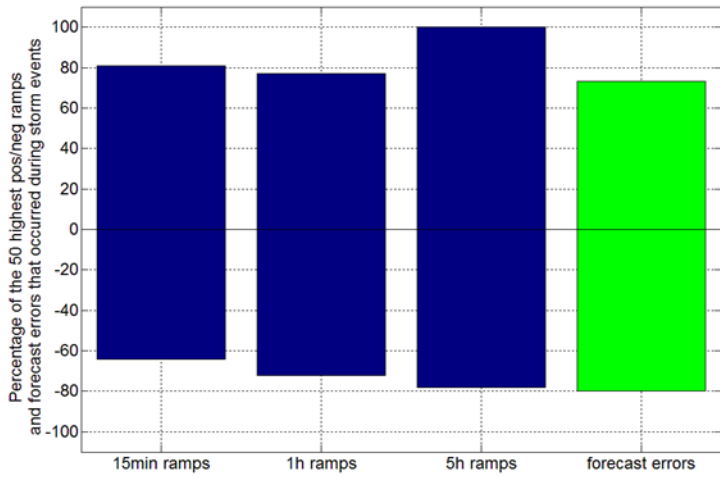

Figure 9. Percentage of the 50 highest positive and negative ramps and forecast errors that occurred during storm events (Source: Fraunhofer IEE).

Table 2. Storm events in Germany: some of the largest ramps and forecast errors and the respective dates and storm fronts (Source: Fraunhofer IEE).

Type	Value	Date	Storm front
15min-upward ramp	-5.8%	11-May-2014	Storm front Xena
15min-upward ramp	-5.6%	16-Feb-2014	Hurricane Ulla
15min -downward ramp	+5.1%	23-Dec-2013	Hurricane Dirk
15min -downward ramp	+4.3%	12-Dec-2014	Secondary Depression Billie
1h-upward ramp	-12.5%	16-Feb-2014	Hurricane Ulla
1h-upward ramp	-10.7%	12-Aug-2014	Ex-Hurricane Bertha
1h-downward ramp	+11.9%	14-Feb-2014	Hurricane Ulla
1h-downward ramp	+10.9%	14-Mar-2014	Storm front Ev
5h-upward ramp	-38.0%	31-Mar-2012	Storm front Ellen
5h-upward ramp	-34.6%	27-Dec-2012	Storm front Silvia
5h-downward ramp	+45.0%	14-Mar-2014	Storm front Ev
5h-downward ramp	+38.9%	05-Oct-2012	Storm front Marianne
Day-ahead overestimation	-19.2%	30-Jan-2013	Storm front Lennart
Day-ahead overestimation	-15.8%	25-Dec-2012	Secondary Depression Rita
Day-ahead underestimation	+21.5%	09-Aug-2014	Storm front Ursula
Day-ahead underestimation	+19.0%	14-Feb-2014	Hurricane Ulla

2.1.3 Smoothing impact and metric for system size and wind dispersion

A metric for quantifying system size and wind power plant dispersion, the "equivalent system radius" (REQ), is proposed in (Olauson et al., 2016). The idea is that a wind power system can be represented by a uniform wind power disk with the same variance as the actual system, assuming an exponential decline of correlation of output with separation distance (Figure 10).

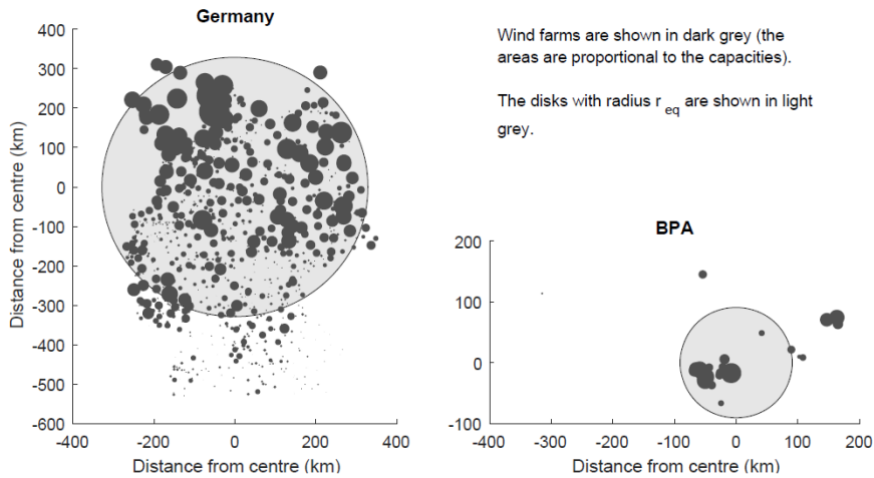

Figure 10. Illustration of the equivalent system radius (REQ) for Germany and BPA. Note that BPA farms are concentrated in a relatively small area which gives a small REQ as compared to the total system dimensions. In particular, the small farm at around (-300,100) does not impact REQ much.

2.1.4 Variability from simulated wind energy generation

Reanalysis data sets are routinely used to model wind power for integration studies. Task 25 work compared the variability and smoothing impact from both actual measured wind power production as well as simulated time series (Kiviluoma et al., 2016). In Sweden, the new reanalysis data was compared to previous one (Olauson et al., 2016). In Denmark, simulation set up for both wind and solar time series has been developed (Nuño et al., 2018; Koivisto et al., 2018).

There have been concerns on how well the model data represent the actual large scale generation including the smoothing impact. As shown in (Kiviluoma et al., 2016), the German and Netherlands data show that even if using well dispersed data to simulate large scale wind power production, using wind speed data from reanalysis (Germany) or measurements (Netherlands) results in higher hourly variability than actual measured large scale wind power production data.

However, the new reanalysis ERA5 from ECMWF perform considerably better than the often-used MERRA-2, both for countrywide generation and for individual wind turbines (Olauson et al., 2016). In average, the errors are around 20% lower for ERA5, but the reduction vary between countries (see Table 3).

Table 3. Results for MERRA-2 and ERA5 as compared to countrywide measurements. In average, mean absolute errors (MAE) and root-mean-square errors (RMSE) are around 20% lower for ERA5. A similar improvement can be seen for the 1000+ studied individual Swedish wind turbines.

Country	Reanalysis	Correlation	RMSE	MAE
Germany	MERRA-2	0.982	2.82%	2.06%
	ERA5	0.987	2.35%	1.66%
Denmark	MERRA-2	0.973	5.40%	3.75%
	ERA5	0.973	5.45%	3.71%
France	MERRA-2	0.975	3.49%	2.63%
	ERA5	0.982	2.97%	2.25%
Sweden	MERRA-2	0.950	6.10%	4.58%
	ERA5	0.975	4.40%	3.21%
BPA	MERRA-2	0.756	18.4%	13.3%
	ERA5	0.945	9.10%	6.06%

Time series simulation tools are useful especially for future scenarios with varying wind and solar installations. The temporal and spatial inter-relations of wind and solar at different time scales need to be captured. In addition, it is important to use renewable generation time series in neighbouring areas with correct correlation. DTU Wind Energy tool generating joint wind and solar time series over a large transcontinental system (Nuño et al., 2018) has been used by the long-term planning of the transcontinental European power system, in the Ten Years Network Development Plan published biannual by ENTSO-E² (Figure 11).

² <https://tyndp.entsoe.eu/>

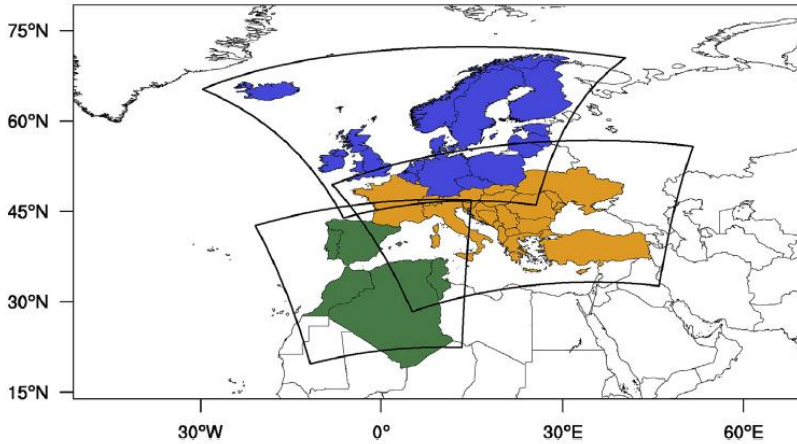

Figure 11. Area covered by the transcontinental simulations of wind and solar generation (Source: Nuño et al., 2018).

The overall time series generation process is presented in Figure 12. The environmental variables derived from the meteorological model has to be translated into electrical power. The annual and seasonal production for each technology has been matched to the real capacity factors.

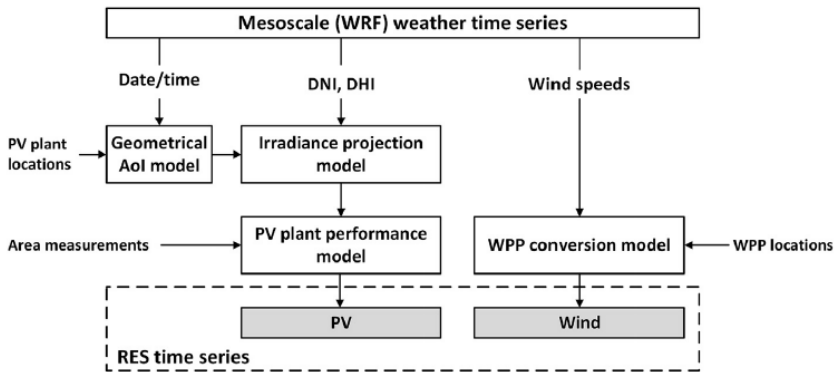

Figure 12. Schematic diagram for the PV power and wind power time series generator (Source: Nuño et al., 2018).

As an illustration, the results for a given meteorological year are shown in Figure 13 (Nuño, 2017 and Nuño et al., 2018).

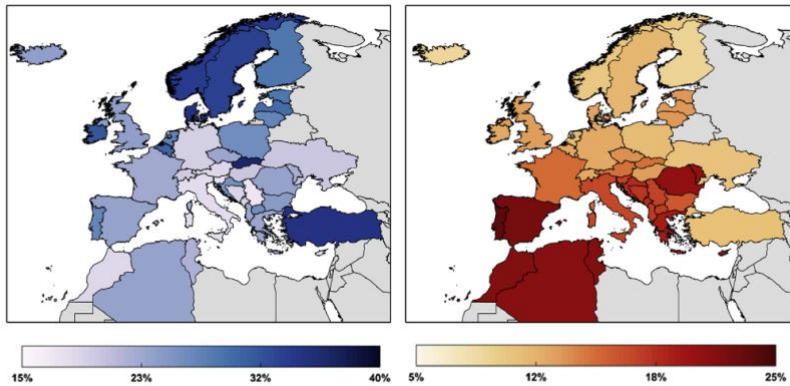

Figure 13. Annual simulated capacity factors for different European countries in 2015 for wind (left) and PV (right) (Source: Nuño et al., 2018).

To address also shorter time scales, a combination of meteorological time series and stochastic simulations is used in DTU tool CorRES (Correlations in Renewable Energy Sources) (Koivisto et al., 2018). As can be seen in Figure 14, the combination of reanalysis data (from WRF) and fluctuation simulations, represent the temporal dependencies in wind generation. The capability of the CorRES methodology to generate joint wind and solar time series over a large transcontinental system is presented in Figure 15 for wind and Figure 16 for PV (Nuno et al., 2018), with results validated for different climatic areas; the presented data-driven solar PV conversion model is an addition to the literature.

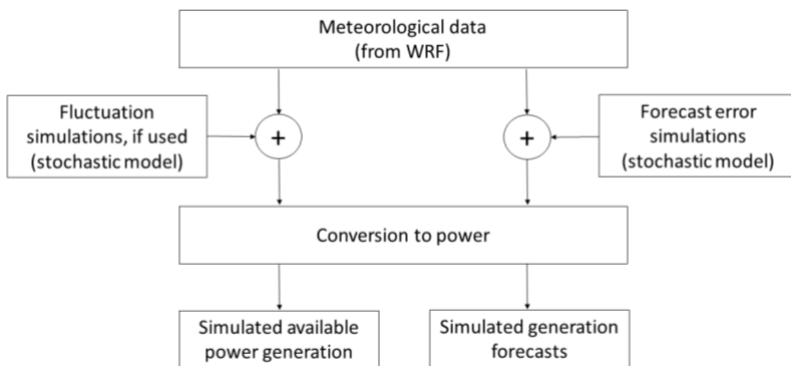

Figure 14. A block diagram of the main parts of CorRES. Simulated available power generation means the generation before, e.g., curtailment.

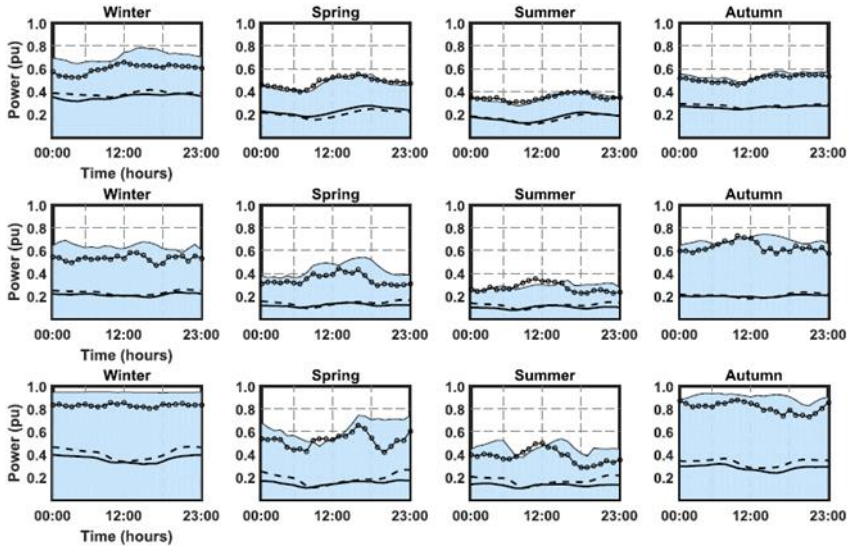

Figure 15. Wind power seasonal average daily production in Spain (top row), Germany (middle row) and Belgium (bottom row) in 2014. The full and dashed lines correspond to the historical and simulated mean production respectively. The dotted line represents the 95th historical percentile and the shaded blue area the 95th simulated percentile (Nuño et al., 2018).

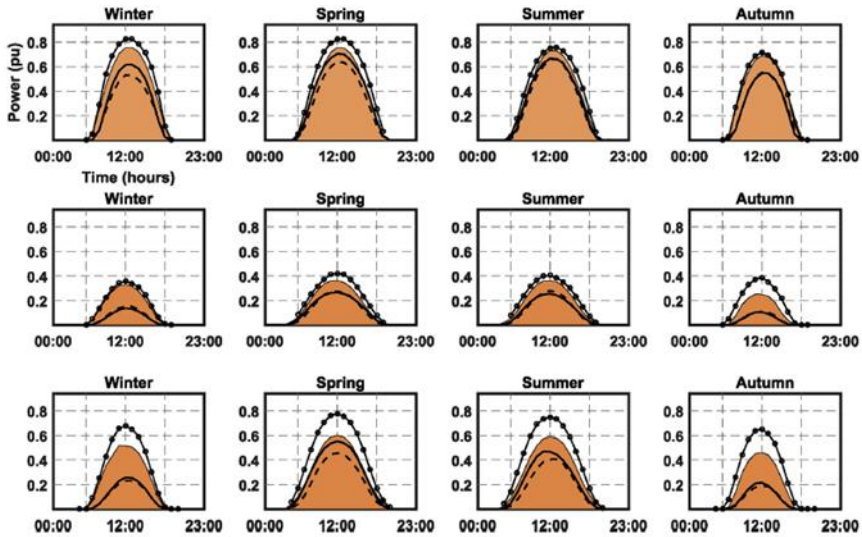

Figure 16. Solar power seasonal daily average production in Murcia, Spain (top row), Bremen and Lower Saxony, Germany (middle row) and Liege, Belgium (bottom row). The full and dashed lines represent the historical and simulated mean

production. The dotted line and shaded orange area represent the historical and simulated 95th percentile respectively (Nuño et al., 2018).

2.1.5 Wind and solar complementarity

The complementarity of wind and solar energy generation can be used to improve their capability to meet the demand. In Portugal, wind and solar capacity options taking into account the resource complementarity (Couto et al., 2017) have been analysed. The optimization algorithm is using the power production time series of wind and solar, allowing an annual excess (surplus) of electricity of 5% regarding the electricity demand. The scenarios and daily profiles obtained are in Figure 17.

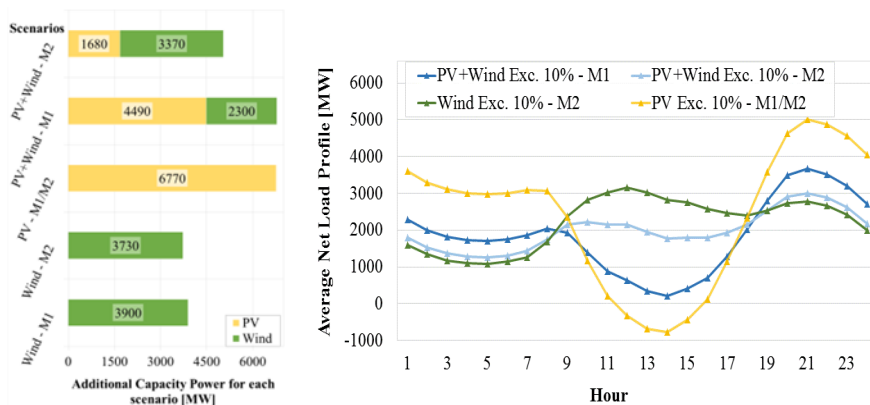

Figure 17. a) Identification of the wind/solar PV power capacity in each scenario, and b) daily profile for all scenarios for a 5% annual energy surplus. M1 and M2 represents the minimization criterion, net load annual variability based on the annual standard deviation, and one-hour net load step change standard deviation, respectively.

In average, using a strategic decentralization of wind power deployment capacity can result in a low net load variability daily profile. In the PV+Wind scenarios, a strong complementarity between the VRE generation is observed. Figure 18 shows the load duration curve for each scenario while Figure 19 depicts the combined wind and solar energy share of electricity consumption. Strategic *PV+Wind* deployment scenarios are the most appropriate to reduce and smooth the net load and to achieve the highest combined wind and solar share for the same annual energy exceedance value (Couto et al., 2017).

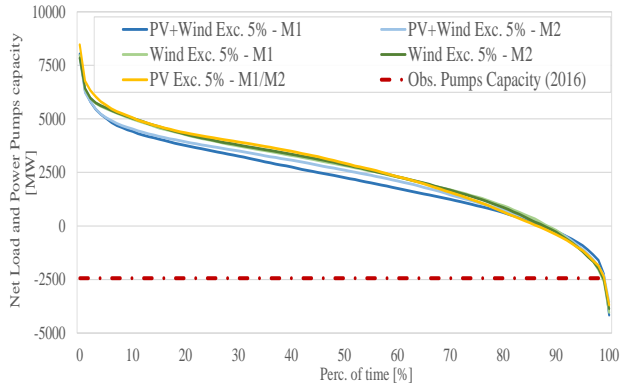

Figure 18. Load duration curve using a 5% annual energy surplus scenario and nominal pumped hydro storage (PHS) capacity in Portugal at end of 2016.

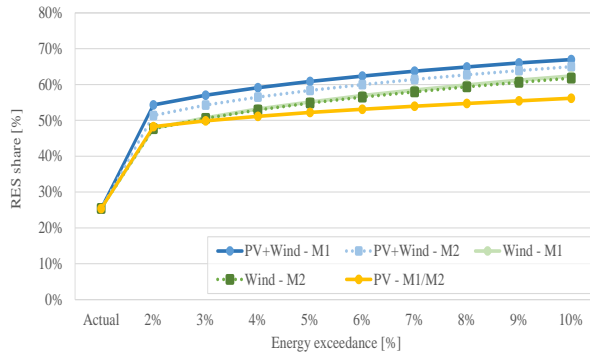

Figure 19. Wind and solar energy share of consumption for the scenarios considering different annual energy surplus values.

2.2 Uncertainty

2.2.1 Forecast errors of wind energy from actual data

The forecast methods and numerical weather prediction are still improving.

In Spain, example of average absolute forecast errors for different (day-ahead) forecast horizons are shown in Figure 20. The average errors for each year of operation still show a reducing trend: about 20% improvement in mean absolute error in 5 years, leading to values for 24-hour-ahead forecasts of approximately 2% of the installed total wind power capacity.

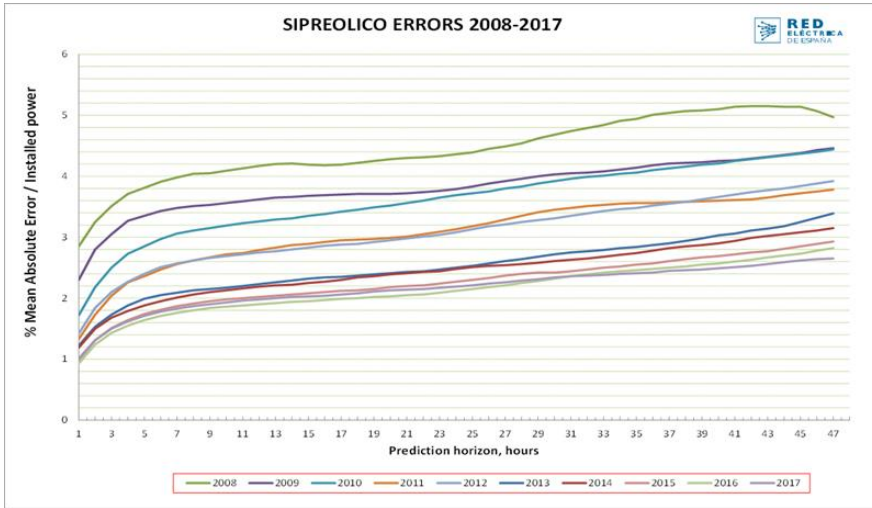

Figure 20. Forecast accuracy improvement: average forecast error for different look-ahead horizons from recent years operation, example from Spain (Source: REE).

In Germany, the analyses of largest forecast errors in day-ahead forecasts are seen in previous section Figure 8. The maximum observed day-ahead forecast errors from more than 3 years of data have been -19.2 and +21.5% of installed wind capacity (the 0.01% and the 99.99% quantiles -18.5% and 18.3%).

In Portugal, Improvement of wind forecasts were made by using new meteorological features (Couto et al., 2018). The methodology is based on a wrapper feature selection approach coupled with NWP forecast. With the feature selection algorithm, it was possible to observe a significant improvement in the probabilistic wind power forecast performance for Crete island when compared with the baseline scenario: the NRMSE for the Artificial Neural Network (ANN) and K-Nearest Neighbour (KNN) decreases nearly 20% and 14%, respectively. The energy/balance settlement error decreased by more than 2.5%.

2.2.2 Analysis of largest forecast errors

Extreme forecast errors that threaten the security of the electrical grid security have been analysed in detail (project EWeLiNE <http://www.projekt-eweline.de/en/index.html> Dobschinski et al., 2016). As an example, Figure 21 shows a weather situation with a strong decrease in wind speed that has not been forecasted by most numerical weather predictions (NWP) (Steiner et al., 2017). The difference of the resulting day-ahead wind power forecast and the observed power production (~7 GW) exceeds the operating reserve of ± 4.5 GW. Such large errors are becoming more common and are critical for the stability of the grid. Concerning this example the error was balanced by a continuous intraday trading based on

additional intraday power forecasts that uses recent wind power measurements in addition to weather forecast.

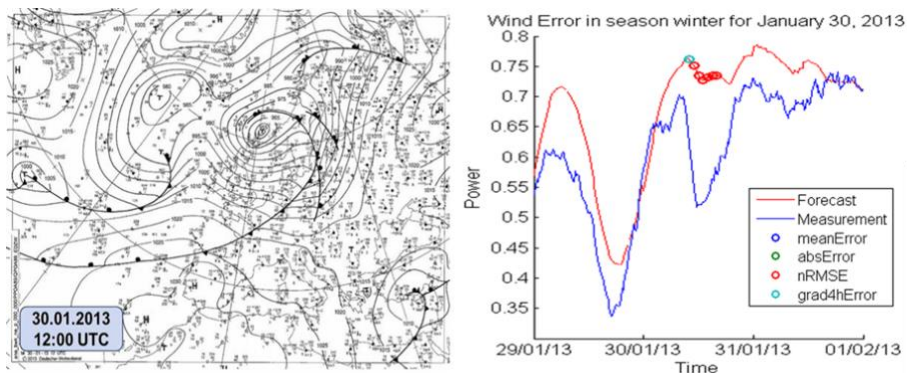

Figure 21. The left plot shows the weather chart of the 30th January 2013 where the strong drop of wind speed has not been predicted. The right plot presents the resulting power forecast in red and the corresponding observation in blue. The times with highest gradient and errors are indicated by the colored circles (Source: Dobschinski et al., 2016).

The forecast errors for the three year time period of 2012 to 2014 show a seasonal dependency with larger or more frequent errors during colder months and a mean absolute error of 2.31% of installed capacity. Subjective analysis on the synoptic scale revealed that in 60.2% of the 88 days with large wind power forecast errors a cyclone or a trough moved over the North Sea, the Baltic Sea or directly over Germany (Figure 22).

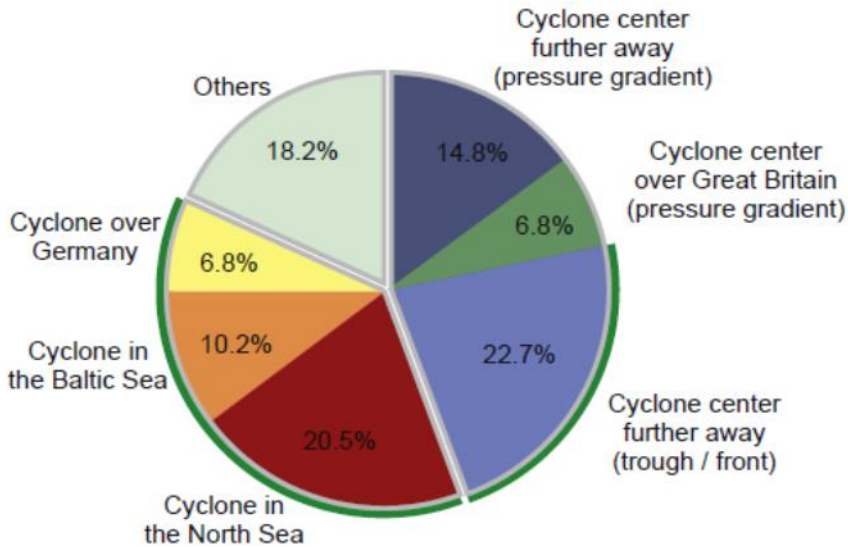

Figure 22. Subjective evaluation of synoptic scale weather elements during dates with large wind power forecast errors. The outermost green lines label the cases, where small scale low pressure systems or troughs could be linked with large forecast errors (60.2%) (Source: Steiner et al., 2017).

To optimize weather and power forecast the following points for improvements have been identified in EWeLiNE project with respect to the numerical weather prediction:

- improvement of the initial state of NWP models by assimilating newly available data such as wind turbine and PV system power data or wind speed measurements at hub height,
- improved physical parameterizations of the relevant atmospheric processes within the NWP,
- improved post processing procedure of the forecast results called model output statistics (MOS) which take into account measurements,
- improved ensemble prediction systems (EPS),
- improved calibration of the probabilistic forecasts.

The conversion of wind to power has to be considered in assimilation of wind and PV data to make sure that this process does not deteriorate the conventional weather and power forecast skills. With respect to power forecasts, the following improvement potentials have been identified:

- better basis of wind and solar power data which comprises more locations and also considers the status of the system (e.g. in operation, power reduction, maintenance, etc.)
- using off-site measurements as input into the power forecast models
- classification of weather situations
- an improved aggregation of wind and solar farms to larger regions

- improved mapping of wind and solar farms to grid nodes,
- Using calibrated probabilistic forecasts to assess the forecast uncertainty in advance
- improved methods to convert ensemble information into probabilistic forecasts
- improved methods to combine different forecast models with respect to the existing weather situation and network state

A follow up project in Germany is using forecasts to improve grid safety (Gridcast), see Section 6.4.1.

2.2.3 Ramp forecasting

In Germany, the project EWeLiNE developed an automated cyclone detection algorithm to recognize the challenging weather situations described in 2.2.2 (Steiner et al., 2017). The cyclone detection is based on mean sea level pressure and uses the Laplacian of the MSLP field as a proxy for the quasi-geostrophic relative vorticity to indicate areas of cyclonic influence. Subjectively chosen thresholds for curvature values as well as for spatiotemporal movement complete the automated cyclone detection algorithm.

In Portugal, the wind power ramps driven by windstorms and cyclones were analysed in (Lacerda et al., 2017). In this work, the authors applied common meteorological cyclone and windstorm detection algorithms to understanding the underlying role and key features (e.g., location, intensity and trajectories) of these phenomena in triggering wind power ramps (Figure 23).

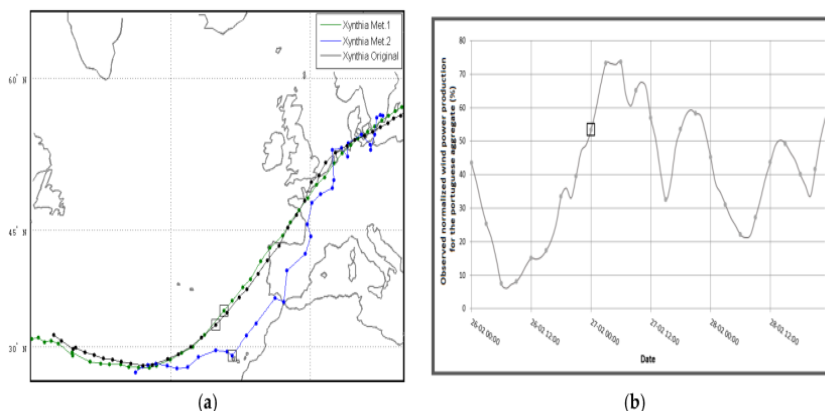

Figure 23. (a) Resulting trajectories for Xynthia storm with a cyclone (green) and wind-storm (blue) detection algorithm implemented by LNEG, official trajectory (black); (b) Aggregate observed normalized wind power production in the Portuguese - adapted from (Lacerda et al., 2017).

The results show a higher association between windstorms and wind power ramp events when compared to the cyclones. Severe variations in the Portuguese wind power production are mainly associated with the cyclones and windstorms originated in the Southwestern region of the Iberian Peninsula. On the other hand, events with trajectories in the North of the Iberian Peninsula tend to produce a high level of wind power production, but are not associated with large wind power ramps. Moreover, the results highlight that it is possible to use some features of these meteorological phenomena to detect, in an early stage, severe wind power ramps thus creating the possibility to develop operational decision tools in order to support the security of supply. It was found that a wind power ramp is not always a consequence or always linked to the existence of extreme wind speed values, being essentially dependent from the previous (historical) state of the flow (Couto et al., 2016). For that reason, a "memory effect" was introduced in the models. Thus, a new algorithm, which includes a time numerical differentiation in order to fit the particular case of wind power ramps events, was developed by LNEG (Couto et al., 2018). The previous algorithms were adapted to Crete Island to detect wind power ramps events in a set of wind parks comprising 154 MW. Results show a significant improvement in the wind power ramp detection when the "memory effect" was introduced: a 82% probability of detection of downward wind power ramps, while the upward probability ramp detection is 81%, with bias score values 1.24 and 1.11 for upward and downward wind power ramps, respectively.

2.2.4 Forecast error data simulations

A new method to simulate wind power forecasts and corresponding forecast errors was discussed (Olauson, 2018). The idea is to model generation from reanalyses and up to one-week-ahead synthetic forecasts based on meteorological "re-forecasts" and some statistical post-processing. This approach has several advantages as compared to simulating synthetic forecasts with purely statistical methods (which is common today).

3. Planning grid adequacy

Large scale wind power will usually require the transmission grid to be upgraded, to enable the wind energy to flow to where it is consumed. The need for reinforcements will depend on the existing grid and location of wind resource exploited. Grid reinforcement costs from national studies have been published before as a summary graph (Holttinen et al., 2009). However, as transmission lines in most cases will be used for multiple purposes, the costs should not be allocated fully to wind power. In previous studies the effort to allocate the costs between different needs was only made in Portugal. In the European TSOs combined effort for ten year network development plans (TYNDP) estimates on allocation are depicted on general level, as share of grid that will be needed for renewables/markets/security (Holttinen et al., 2016a).

Planned investments in transmission grid will reduce bottlenecks and improve system flexibility. New tools, uncertainty analyses and regional collaboration will be needed for future systems with higher shares of wind power, as mentioned in a Nordic system operator report (Statnett, FG, Energinet, SvK, 2016).

3.1 European grid scenarios for high shares of wind power

Building global grid architectures for the whole of Europe for long term horizon scenarios was addressed in European project e-Highways. New methodologies for the development of the European transmission grid towards low carbon objectives, translated at national and local levels were developed. An invariant set of transmission requirements was identified Figure 24. This is in consistency and in continuity with the Ten-Year Network Development Plan conducted by the European system operators' entity ENTSO-E.

The benefits for the European system, resulting from the optimal use of energy sources, largely exceed the transmission grid costs. The proposed architectures integrate the present pan-European transmission grid, without needing a new separate 'layer' within this existing transmission network (an extra high voltage super grid) (Sanchis et al., 2015).



Figure 18: Grid architecture for 2040, robust to the five scenarios (grey: starting grid, purple: reinforcements)

Figure 24. The most robust Europe wide grid architecture for a low carbon future 2040 from e-Highways project (Source: e-Highway2050 project <http://www.e-highway2050.eu/>).

3.2 US Eastern interconnect

In the US, the Eastern Renewable Generation Integration Study (ERGIS) examined the operational impacts of up to 30% variable renewable energy penetration on an annual basis in the eastern interconnection. The system was found to be able to be operated reliably in all studied scenarios of transmission build-outs (Bloom et al., 2016). The Eastern Interconnection was modelled with a unit commitment and economic dispatch model with over 5,600 generating units and 60,000 transmission nodes at a 5 minute temporal resolution to understand the sub-hourly impacts of

large-scale adoption of wind and PV power. To solve such a large system over yearly timeframes advances were made in time-domain partitioning to parallelize simulations, reduce computational limitations, and enable high-resolution operations analysis. Significant changes in system operations were observed in the operation of thermal and hydro generation, in the power flows on transmission lines, operations at sunrise and sunset, and balancing area operational practices.

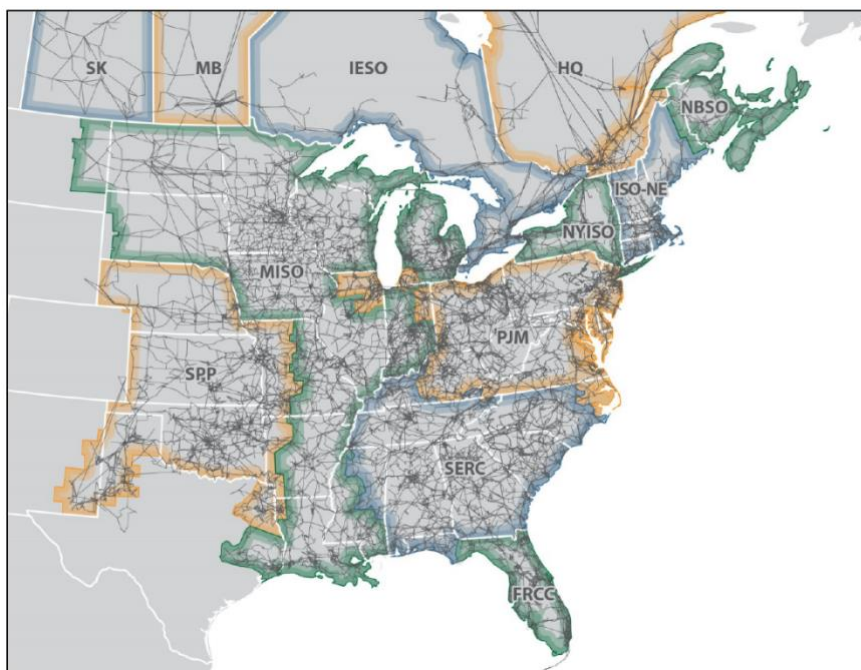

Figure 25. Base transmission network of the Eastern and Quebec interconnections (Source: Bloom et al., 2016).

3.3 Canadian grid for 20–35% share of wind

The Pan Canadian Wind Integration Study (PCWIS) concluded that incremental additions of 4.655–9.65 GW of incremental transmission capacity would be needed in order to achieve a national wind share of 20–35% (respectively). Transmission reinforcement was modelled in each Canadian province, including new transmission capacity between key US and Canadian balancing areas such as between Michigan and Ontario, as well as between key Canadian jurisdictions such as Nova Scotia and New Brunswick. It is noted that the amount of reinforcements needed in Ontario represents nearly three quarters of all new transmission capacity or reinforcements in the 35% scenario, and nearly 80% of additional needed capacity in the 20% scenarios (Figure 26).

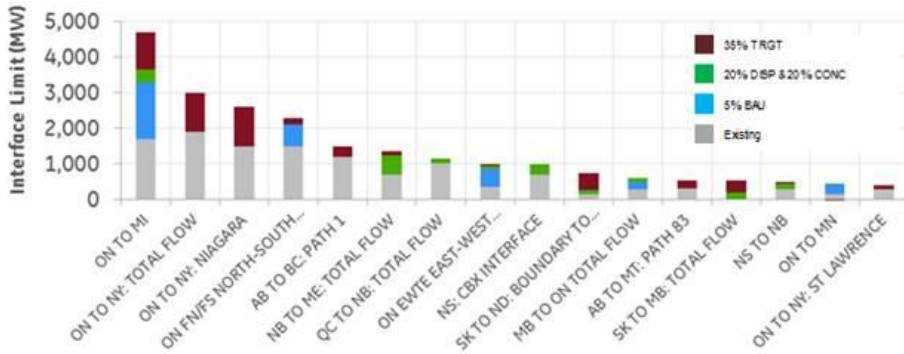

Figure 26. Existing and new transmission capacity for Pan Canadian Study Scenarios.

While the PCWIS shows that inter-area transmission reinforcements would be required to accommodate the increased levels of wind generation in order to relieve congestion and limit curtailment, it also shows the simple payback period is short, ranging from three to four years. Production simulation results show that the capital investments for the new transmission needed would be offset by operating cost savings, in part because there are no fuel costs for wind energy (researchers used an approximate straight line payback analysis, and did not account for interest, financing costs, etc.).

3.4 Overplanting wind capacity to transmission line

Capacity optimization can lead to a so-called overplanting, where a larger wind power capacity will be installed to the site than stipulated in the connection agreement with transmission system operators (TSOs). A technically straightforward concept (Figure 27), overplanting's value is mainly determined by the regulatory regime. Offshore wind power plants in UK show benefits in overplanting (Wolter et al., 2016).

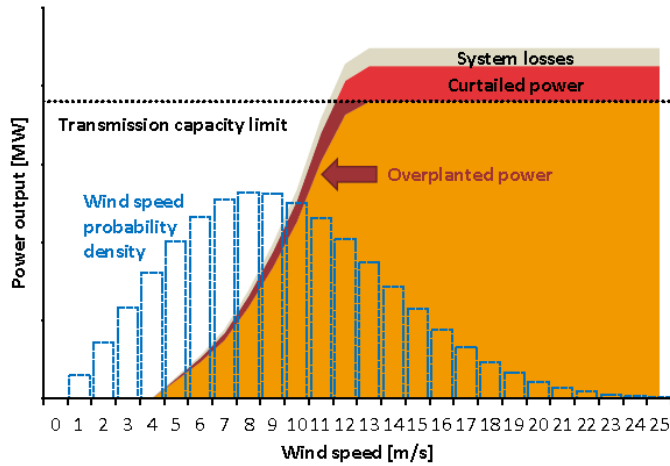

Figure 27. Illustration of the concept of overplanting (Source: Wolter et al., 2016).

3.5 Offshore grids

Previous work on offshore grids in Europe North Sea has been reported in Task 25 summary report (Holtinen et al., 2016a). This section outlines the more recent work by ENTSO-E (TYNDP16 edition) as well as EU project PROMOTioN and the new concept introduced by North Sea Wind Power Hub (NSWPH).

In addition to the projects described above, also collaboration at a political level (North seas Countries energy collaboration (NSCEC³) is ongoing in Europe. The infrastructure support group of this collaboration intends to identify potential hybrid project clusters by observing offshore developments related to interconnections and offshore wind. This is work of the predecessor (North Seas Countries' Offshore Grid initiative, NSCOGI) where the integration of offshore generation and related implications on the infrastructure was previously analysed with a technical study published in 2012. Even if the expectations on offshore RES development in country level were lower in 2017 than they were during the NSCOGI investigations, the political awareness and stakeholder expectations with regards to off-shore infrastructure development has increased and previous results from the NSCOGI studies are still valid even if the location of some of the elements, and the year of realisation, may have changed.

The Ten-Year-Network development plan TYNDP16 edition of European ENTSO-E had four 2030 Visions, assuming between 30 and 80 GW offshore and 110 to 155 GW onshore wind. For offshore wind, a parallel development different designs using both AC and DC technologies was assumed:

³ Political Declaration. Available at: <https://ec.europa.eu/energy/sites/ener/files/documents/Political%20Declaration%20on%20Energy%20Cooperation%20between%20the%20North%20Seas%20Countries%20FINAL.pdf>

- i) point-to-point interconnections,
- ii) radial offshore wind connections (single or via hubs),
- iii) hybrid projects, (combination of offshore wind connections and interconnections) and
- iv) multiterminal offshore platforms combining interconnections.

This is based on comparisons made between the previously published NSCOGI grid study, the ENTSO-E Ten-Year-Network development plan TYNDP14 analyses as well as a consultant study launched by the EC. A modular and stepwise offshore grid development with choices being made on a case-by-case basis, evaluating technical and economic parameters is assumed. A compact hybrid off-shore design could be envisaged in cases, where scheduling and technology required for interconnection and wind connection (DC or AC / voltage level) match. In any case, the cooperation between all stakeholders of all countries involved is essential.

The combined on- and offshore infrastructure was deemed robust in all four different visions, although transporting electricity produced by different fuels. While the infrastructure in one Vision was merely used for the transport of conventional energy causing an even increasing regional CO₂ level, the other three visions had a better green footprint. However, results for all four visions showed rather similar economic benefits. A decision on which future to go for is taken at political level.

Additionally, the ENTSO-E TYNDP16 summarized the envisaged individual subsea projects into one single project (Figure 28) and evaluated its costs and benefits. The individual modules each follow their own project plan with commissioning dates between before 2020 up to 2030, for which cost benefit assessments are also provided in the TYNDP16. The key results of this investigation can be summarized as:

- 25 individual projects develop into a global scheme at infrastructure costs of 12–25 bn €,
- delivering socio-economic benefits of 2–3 bn € annually,
- facilitating additional annual renewable energy integration of 15–32 TWh and
- delivering a CO₂ variation of +10,200...-19,500 kt / yr.

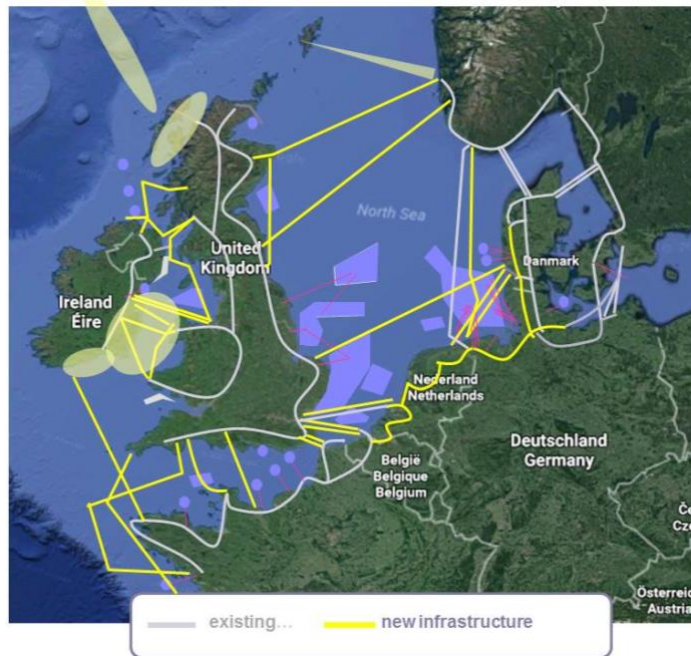

Figure 28. Offshore Grid Infrastructure as in Ten-Year-Network development plan TYNDP16 (Source: ENTSO-E).

The EU project PROMOTiON (PROgress on Meshed HVDC Offshore Transmission Networks, <https://www.promotion-offshore.net/> 2016–20) is demonstrating two essential technologies to gain operational experience with the required protection and fault clearance technologies associated with HVDC grids:

- HVDC grid protection systems: demonstrating application within a full scale of Multi-Terminal Test Environment. The multi-vendor approach aims to ensure interoperability with regards to DC grid protection.
- HVDC circuit breakers: demonstrating the performance of existing HVDC circuit breaker prototypes to provide confidence and demonstrate technology readiness of this crucial network component.

Additionally, a Diode Rectifier Unit is being considered as a possible cost reducing technology. This technology concept challenges the need for the more complex (Voltage Source Converter) VSC converters, thus reducing investment and maintenance costs and increasing availability. To eliminate regulatory barriers associated with a meshed offshore HVDC grid, the project aims to develop international regulatory and financial framework, essential for funding, deployment and operation of meshed offshore HVDC grids.

The North Sea Wind Power Hub (NSWPH) is a joint initiative started by system operators TenneT TSO B.V. (Netherlands), Energinet (Denmark) and TenneT TSO

GmbH (Germany). It is a vision on how to make the transition to remote large-scale offshore wind feasible and affordable. Cost saving potential related to offshore platforms is assumed to be activated by building artificial islands instead, potentially merging cross-sectorial assets as well. The promoters emphasize that North Sea Wind Power Hub (NSWPH) is still a conceptual project, which needs to be further studied and refined. Large amounts of offshore wind located nearby could be connected to this island via AC technology and, from the island, multiple HVDC connections will connect into surrounding North Sea countries. The advantages of this conceptual idea include:

- Allowing for synergies in infrastructure, by combining wind farm connections and regional interconnectors;
- Enabling the construction of traditionally costly offshore equipment in an onshore environment- for example offshore HVDC platforms.; and
- The allocation of offshore wind farm logistics, assembly centres and crew on the island.

The Dogger bank area seems to be a potential area, as there five countries' borders meet, waters are shallow and more countries might wish to participate. The goal of the project is to collaborate with regional parties and allow both the cost-effective connection of remote offshore wind in the Dogger Bank area, and the development of a resilient, inter-connected, regional transmission system. The concept is demonstrated in Figure 29. The present concept would involve up to three islands, each covering an area of 6 km². The creation of these islands would involve the dredging of 200 million cubic metres of sand. Each island is anticipated to facilitate approximately 30 GW of offshore wind generation, connected via AC connections. The islands themselves would be inter-connected via 15 HVDC links, each of 2 GW in size. Overall, between 70 GW and 100 GW of offshore wind generation, covering an area of between 11,000 km² and 20,000 km², could be connected to these islands. Hard substrates would cover an area of about 4.4 km², equivalent to about 0.02% of the total Dogger Bank area. This area is presently part of a protected area. The implementation of a project of this scale would require considerable studies into the environmental impact of such infrastructure.

According to project promoters, the North Sea Wind Power Hub concept is estimated to provide a 7% LCOE (levelized cost of energy) reduction for offshore wind when compared to present close to shore AC connected offshore wind. The project will continue to further analyse engineering challenges, suitable market arrangements, necessary regulatory frameworks, necessary flexibility and the potential reduction in costs associated with the concept.



Figure 29. North Sea Wind Power Hub concept with Energy Island concept (left) and the option of increased regional interconnection (right).

4. Ensuring long term reliability and security of supply

Wind power will provide more capacity and thus add to the reliability of the power system. However, the benefits of added capacity vary depending on how much wind resource is available during times of peak loads. In most countries this is not a critical question in the start of deployment, however, there is already experience from conventional power plants withdrawing from the market due to reduced operating times and full load hours to such an extent that their economics deteriorate. This will raise the question of resource (or generation) adequacy in the power system.

To assess resource (generation) adequacy, capacity value of wind power needs to be assessed. The recommended practice for capacity value calculation is based on Loss of Load Probability (LOLP) (Holtinen et al., 2012). The analyses are based on statistical metrics and risk analysis. Due to variability and uncertainties related to wind, solar and demand, it is important to have the spatial and temporal correlations between weather dependent data covered.

Addressing concerns of generation capacity adequacy in future systems where wind and solar energy reduce the energy-only market prices is another concern that has been studied.

Recent progress in the capacity value assessment of wind power has been summarized in an IEA WIND Task collaborative article (Milligan et al., 2017). Additional metrics beyond the traditional Loss of Load Expectation (LOLE), like Loss of Load Hours (LOLH) and Expected Unserved Energy (EUE), have shown little impact in capacity value estimates. The summary of capacity value for wind power from different studies is presented in (Holtinen et al., 2016b).

4.1 Estimating capacity value of wind power

4.1.1 Results from national studies - Canada

Capacity value estimates for Canada were assessed in the Pan Canadian Wind Integration Study (Table 4) (PCWIS, 2016). Data available was only 3 years, which makes the estimates somewhat uncertain. For Quebec area, previous Task 25 summary report has reported a 30% capacity value for 4% wind share using a robust multiyear analysis (Holtinen et al., 2016a; Bernier & Sennoun, 2010).

Table 4. Canada-Wide Wind Capacity and Capacity Value for three levels of wind share in the power system.

Scenario	Wind capacity (MW)	Capacity value (MW)	Capacity value (%)
5% BAU	10,966	3,987	36.4%
20% DISP	37,114	8,251	22.2%
20% CONC	36,312	8,118	22.4%

4.1.2 Multiple year data sets needed for capacity value estimate

Multiple-year data sets significantly increase the robustness of results compared to single-year, or even 1–5 year assessments. This is due to inter-annual variability in the wind resource. In Ireland, 8 years was enough to reach robust results for capacity value of wind (Hasche et al., 2011). In some systems more than 10 years of data is needed to get robust results on capacity value of wind power (example from Finland in Figure 30).

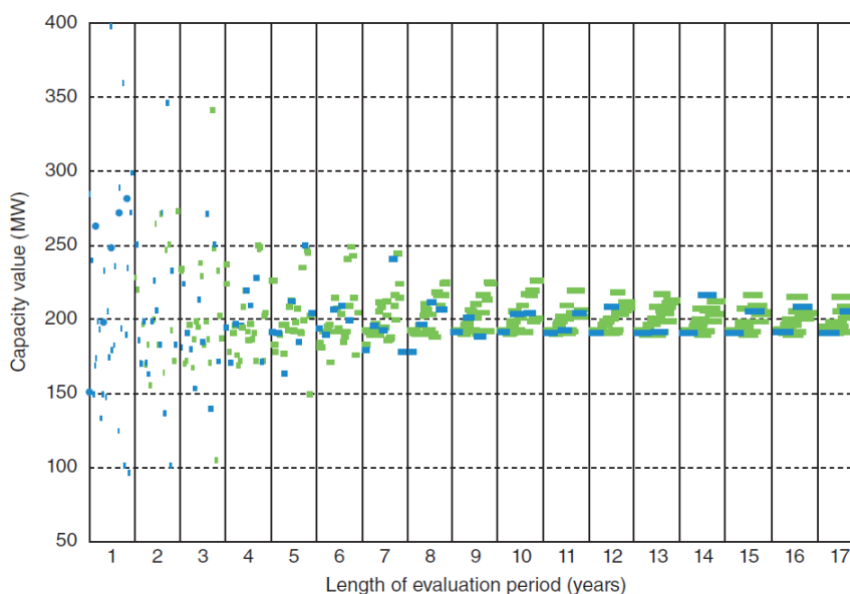

Figure 30. Capacity value of wind power using different number of years for evaluation. The data is based on 35 years of NASA/MERRA data. Blue markers signify independent time series and green markers have partial overlap with some of the other time series (Source: Milligan et al., 2017).

In France, the adequacy outlook (up to 10–20 years ahead) concerns the uncertainty from the political contexts (support of renewables, nuclear power,...)

and the macro-economic situation (fossil fuel prices, economic growth, technological breakthroughs,...), but the meteorological variables also play an important role. When wind is low or weather is cold it affects not only one country but its neighbours, too (Figure 31). The use of spatially, temporally and inter modal (i.e. between demand, wind and solar) hazard correlations is then crucial to obtain trustful results.

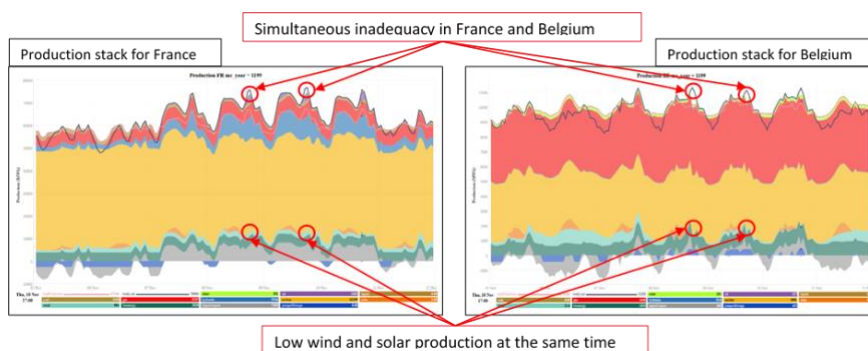

Figure 31. System analysis between two countries (Source: RTE, France).

The system operator RTE uses 200 weather scenarios (wind at 100m, temperature at 2m, global irradiance and cloud covering...) covering Europe with a 50 km resolution for determining wind and PV productions per area/country (according hypothesis of capacities installed, and tuned transfer function). These scenarios come from simulations computed by numerical weather model (Figure 32). Data have been cross validated with different sources (ARPEGE analysis, ERA Interim) according different criteria such as, for wind, speed distribution (min, max, percentiles...), autocorrelation, daily profile, geographical correlation, distribution depending on direction.

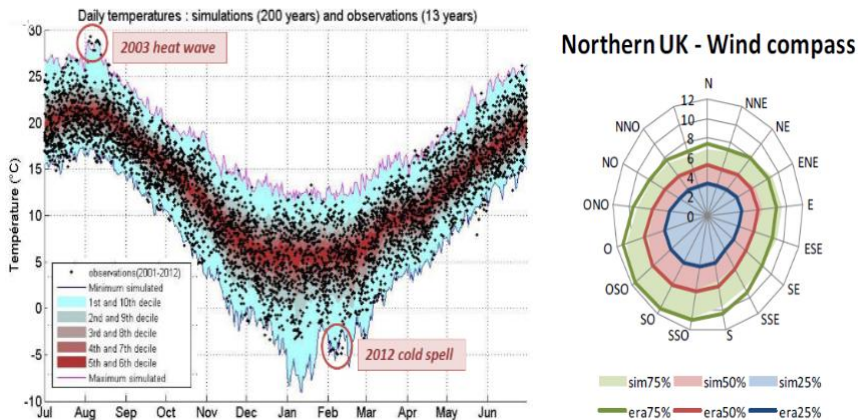

Figure 32. Example of weather data analysis (Source: RTE, France).

At EDF(Electricité de France) (main producer in France), choice has been made to consider 93 scenarios (1 year with hourly resolution) of time synchronized demand, hydro, wind and PV, for 31 weather years (real data) combined with 93 years of generation availability (from outage simulations).

4.1.3 Multi area methods for capacity value

In Sweden a method for power system reliability in multi-area systems has been developed and applied to the Nordic Power system considering correlated wind power in the different areas. This means that LOLP per area is estimated considering possible import. Simulations for three future scenarios (2020, 2025 and 2030) point out that the weakest areas (Finland and Southern Sweden) are also the ones that will face nuclear decommissioning in years to come, and highlight that the investments in interconnections and wind power considered in the scenarios are not sufficient to maintain the current reliability levels. If today's reliability levels are considered necessary, then possible solutions include more flexible demand, higher production and/or more interconnections (Terrier, 2017).

European system operators (ENTSO-E) release a Mid-term Adequacy Forecast (MAF) report every year. This is a pan-European assessment of power system adequacy spanning over the next 10 years. The MAF is based upon a probabilistic analysis conducted using several TSOs' market modelling tools. All market modelling tools have performed Monte Carlo simulations (up to 2000), built by the combinatorial, stochastic process of contingencies: climate years (1982–2015) for load, wind and solar are chosen one-by-one and combined with the three possible hydro conditions (wet, dry, normal). Each set of climate + hydro condition is further combined with up to 300 Monte Carlo realisations of Force Outages for thermal units and HVDCs/HVACs interconnections. The methodology is subject to constant evolution and further improvements. In the MAF 2017 1) a new sensitivity

simulation with estimated risk of generation mothballing or capacity exit, 2) the effect of area aggregation on load ramps (need of flexibility), and 3) a representation of Demand Response based on the information collected by TSOs were introduced. Expected major improvements in future reports include the implementation of flow based modelling and the extension of the climate database to cover hydrological conditions (MAF, 2017).

4.2 Capacity adequacy concerns from low market prices

Wind and solar have close to zero marginal price and will press down the electricity market prices during hours when they are abundant. In Europe, the impacts of wind on prices have been reported before from Denmark, Germany and Spain. However, overcapacity is another reason for low prices in markets. In the US, a report by the DOE found that low natural gas prices were the main culprit in driving coal and nuclear out of the markets, and that the retirement of coal plants has not impacted reliability (<https://www.energy.gov/downloads/download-staff-report-secretary-electricity-markets-and-reliability>).

4.2.1 Revenue sufficiency from future electricity market prices in high shares of wind and solar

Consequences of not having capacity markets in Europe shows tighter margin and higher price spikes in Nordic scenario for 2025 (Statnett, 2015). To accommodate the changes in the power system in a market-based and efficient way the current market model should be developed further. Nordic TSO report recommends higher price maximum and ensuring that price signals reach market participants. If proper price signals do not reach market participants, the latter cannot react adequately, be it short-term responses to shortage situations or long-term investment decisions (Statnett, FG, Energinet, SvK, 2016). The TSOs are working on four concrete projects that will contribute to solving the adequacy challenge (Statnett, FG, Energinet, SvK, 2018):

- Higher time resolution in the power markets, to reduce the magnitude of structural imbalances, which in turn frees up reserves and improves the frequency quality in the Nordic power system.
- Full cost of balancing to improve the incentives for balancing responsible parties to be in balance. This will also contribute to the adequacy situation by improving market rules to bring more flexibility.
- Common Nordic capacity calculation methodology will maximize the welfare created from the utilization of the grid, which will be important also for tackling the regional adequacy challenges.
- Empowering consumers: Enabling consumers to benefit from potential flexibility in their demand by utilizing smart technology and developing new services and products in retail, wholesale and balancing markets.

While variable generation is likely to suppress whole sale electricity prices in the short term, the prices would rebound if the generation portfolio re-adjusts over longer term with less base load generation and more peak load generation. Unsurprisingly, there would be more hours with low and high prices. CO₂ prices were shown to strongly influence average prices even in a power system with little remaining fossil generation, but ample reservoir hydro power generation, as seen in Figure 33 (Helistö et al., 2017).

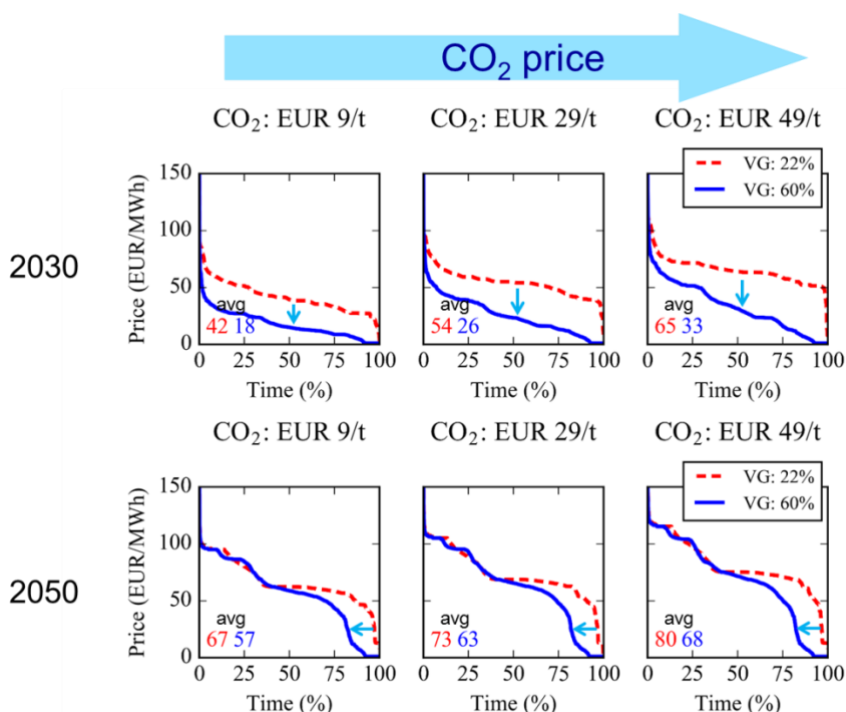

Figure 33. Estimated energy only market prices for year 2030 where considerable overcapacity and for 2050 with tight capacity margin – impact of increasing CO₂ prices and increased share of variable generation (wind and solar, VG). (Source: Helistö et al., 2017).

4.2.2 Addressing capacity adequacy in energy only markets with scarcity pricing

In ERCOT, a dynamic operating reserve demand curve was recently implemented, which provides a price adder to the energy price that is based on the loss of load probability throughout the day. The use of an Operating reserve demand curve (ORDC) values all available operating reserve capacity in the short-run time horizon based on the Value of Lost Load (VoLL) and the Loss of Load Probability (LOLP). When operating reserves drop to 2,000 MW or less, the ORDC will automatically

adjust energy prices to the established VOLL, which is set at \$9,000 per megawatt-hour (MWh), as illustrated in the figure below (Figure 34). As long as reserves exceed the 2,000 MW trigger, the impact to energy prices will be lower because an outage is less likely. The intent here is that when reserves fall below the minimum contingency reserve, the ORDC sets the price for marginal capacity at the maximum. Another important aspect of the ORDC and how it differentiates from shortage pricing in other markets, is that the demand curve extends (albeit at very low price) well beyond the normal reserve requirements such that there is always some adder to the energy price.

Operating Reserve Demand Curve (ORDC)

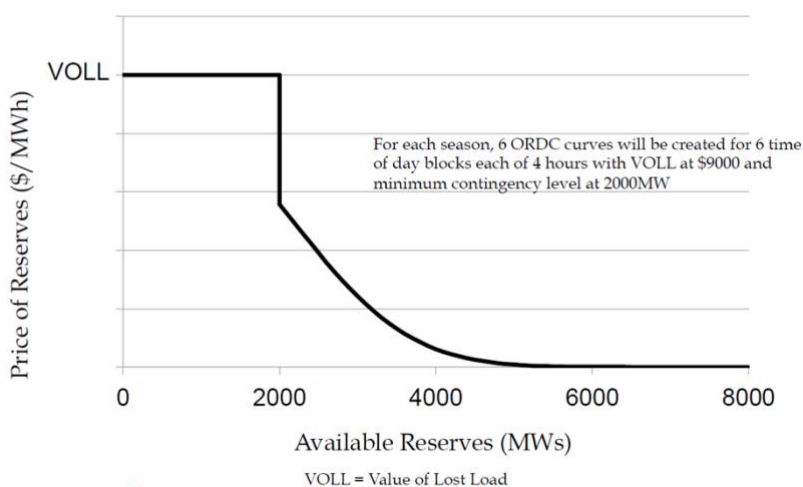

Figure 34. Providing scarcity signal to balancing resources, Operating reserve demand curve used by system operator ERCOT in Texas, US (Source: https://www.ferc.gov/CalendarFiles/20160629114652-3%20-%20FERC2016_Scarcity%20Pricing_ERCOT_Resmi%20Surendran.pdf).

5. Guaranteeing short term system reliability

Impacts of wind power on short term reliability involve potential impacts on power system stability as well as on short term balancing or supply and demand: setting the amount of operational reserves for frequency control. The impact of wind power on power system dynamics is becoming increasingly apparent with larger shares of wind power, and it will become a more important area to study in wind integration studies. Wind power has possibilities to support the grid, and this is taken into account in more recent work. The impact of wind power on operational reserves for frequency control has been the focus of many integration studies for decades.

5.1 Stability and grid security

Wind generation, by its mere presence, does not necessarily worsen the stability of a system, but it does change its characteristics, as it is increasingly connected via power electronics interfaces. Wind power plants can also offer a promising and viable option for defence against short term voltage and frequency instability in emerging situations and through intelligent coordination of power electronic based controls, system capabilities can be enhanced. The issues of concern for a particular system will depend on system size, wind distribution relative to the load and other generation, along with the unit commitment and network configuration (Flynn et al., 2017).

5.1.1 Experience on stability issues with variable generation

In Southern California, an event (August 16, 2016 Blue Cut Fire) highlighted misunderstandings of inverter operation, standards and conflicts in interconnection agreements that are now being addressed. The fire led to a line-to-line fault on the 500kV system. As a response to this fault, 1178 MW of transmission-connected PV tripped off-line. North American Electric Reliability Council (NERC) set up the Inverter-Based Resource Performance Joint Task Force to investigate this reliability issue (NERC, 2017). Twenty-six PV systems were affected and included ten different inverter manufacturers. About 700 MW of PV tripped (ceased to energize and did not return to service for 5 minutes) because fast transients confused one type of inverter to measure a very low frequency (they were set to trip in 10 ms if frequency declined to 57 Hz or lower). This type of inverter is now implementing a 5 s delay for under-frequency tripping and a 2 s delay for over-frequency tripping to avoid similar issues in the future. About 450 MW of PV momentarily ceased (temporarily suspended current injection) due to low voltages ($<0.9p.u.$), and then after a 50–1000ms delay ramped up to full output, which took about 2 minutes. Simulations were conducted and found that about 7200 MW of inverter busses could see low enough voltages to momentarily cease output. NERC recommends that inverter output be restored within 5 seconds.

5.1.2 Studies for stability issues

EU project MIGRATE (Massive Integration of Power Electronic Devices <https://www.h2020-migrate.eu/>) evaluated stability phenomena in systems with high shares of renewable energy (up to 70%), with wind power generation selected as the main type of renewable energy that displaces bulk conventional (fossil fuel fired) power plants. Among the evaluated stability phenomena are frequency stability, rotor angle stability, voltage stability, and sub-synchronous controller interactions. Key performance indicators (KPIs) to quantify the distance and tendency of a power system to move to instability have been made (Table 5). The indicators are mapping information from key variables (e.g. power electronic to load ratio) into metrics (e.g. normalized voltage stability index) that reflect the sensitivity of the system to structural changes (due increasing penetration levels of renewables) affecting its dynamic performance. The KPIs were tested on the reduced size model of the Great Britain System and the Irish System, which included high shares (above 50% from total power share) of wind power generation.

Table 5. Performance indicators for system stability for high share wind power system (Source: MIGRATE project, Rueda Torres et al., 2017).

Model problem	Developed indicator	Stability issue
“model problem for frequency performance in the frequency containment period”	Characteristic curves of change in ROCOF/NADIR as a function of the variation of inertia/kinetic energy (from actual measurements).	Decrease of inertia
		Missing or wrong participation of PE-connected generators and loads in frequency containment
“model problem for large-disturbance rotor angle stability”	Change in maximum angular deviation as a function of variables selected automatically by a self-tuned decision tree.	Reduction of transient stability margins
“model problem for small-disturbance voltage stability”	Characteristic curves of normalised Voltage Instability Sensitivity Index (N-VISI) as a function of the system loading level and the ratio of demand supplied by power electronic interfaced generation and cross-border interconnectors.	Loss of devices in the context of fault-ride-through capability
		Lack of reactive power
“model problem for sub-synchronous controller interactions”	Distance to sub-synchronous controller interactions based on estimated grid resonance frequency, actual wind speed, and actual active power set-point of the involved wind power plant	PE controller interaction with each other and passive AC components

5.1.3 Studies on frequency stability impacts of wind power

The power system will experience times of lower inertia levels due to higher shares of asynchronous wind and solar generation. The inertia of different power systems has been studied and reported starting from the small synchronous system Island of Ireland (see previous summary report (Holtinen et al. 2016a), or the DS3 programme).

The future inertia levels of the Nordic synchronous system has been estimated to be 1–19% of time below the required 120–145 GWs for different years (on average 8%) in 2025, due to added wind and solar power (Figure 35) (Statnett, FG, Energinet, SvK, 2016). The future inertial response of the large European synchronous system is presented in Section 7.4.

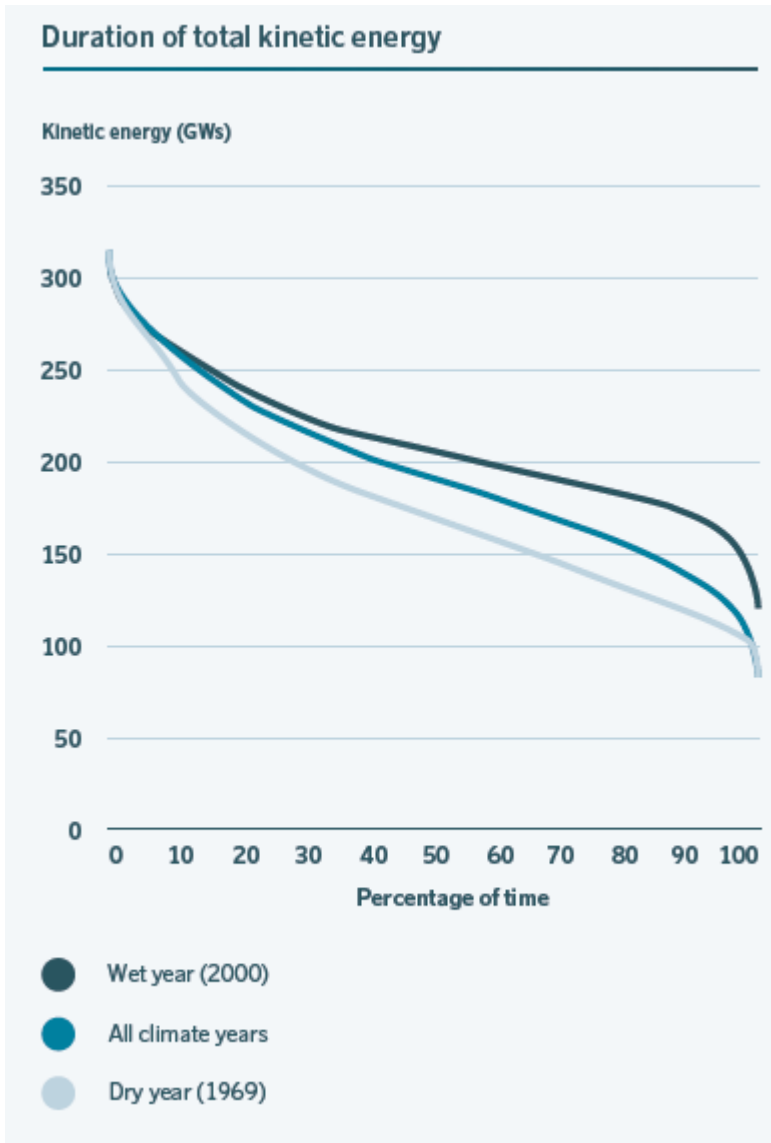

Figure 35. Duration of estimated total kinetic energy for all the climate years (1962–2012), for a dry year and a wet year in the market simulation scenario in 2025 (Source; Statnett, FG, Energinet, SvK, 2016).

5.1.4 Impact of HVDC connections on stability

With the expected development of offshore HVDC connections from point-to-point towards multi-terminal (MT) and eventually into meshed grids, issues as the

capability of offshore wind power plants to provide frequency support when connected to more than one synchronous areas has been investigated (Sakamuri et al., 2017). A possible topology is illustrated in Figure 36.

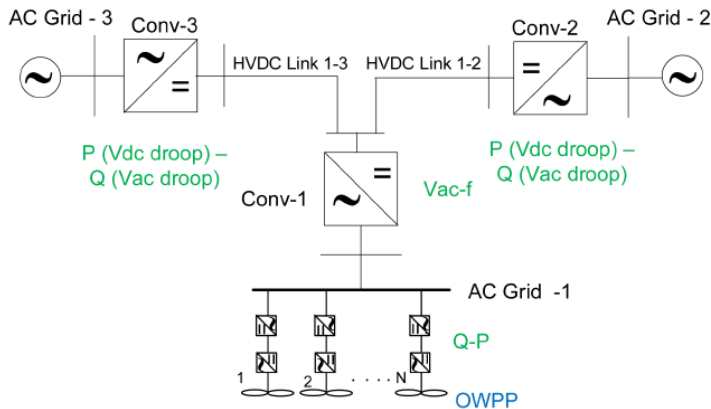

Figure 36. Three-terminal HVDC grid layout (Sakamuri et al., 2017).

In the NL offshore wind power plants with VSC-HVDC connection have been modelled, including negative sequence current control, to achieve an optimal tuning of fault-ride through compliance strategies for offshore wind power plants. An enhanced grid forming control scheme has been proposed for the offshore VSC-HVDC station which enables robust fault ride through compliance and injection of reactive current for a three phase to ground faults at the terminals of the offshore VSC-HVDC station (Ndreko, 2017).

In Norway, the stability in the Nordic power grid in a 2030 scenario was addressed (Vrana et al., 2017). In this scenario, wind power is predominantly outside the Nordic power system, but Norway is balancing the wind power in other North Sea countries through a large number of HVDC links. The total HVDC power capacity will be 13100 MW (excluding some smaller systems) by 2021. A future scenario with additional 7400 MW of HVDC interconnection capacity for power exchange was simulated with DIgSILENT PowerFactory, considering an aggregated representation of the future power grid. The preliminary power flow results indicate that capacity and voltage constraints within the Nordic power grid will be a limiting factor for the power exchange (Figure 37). The first dynamic results indicate that future high import scenarios can give more oscillations after disturbances compared to scenarios with less import, considering generic converter controllers that are not tuned to damp these oscillations.

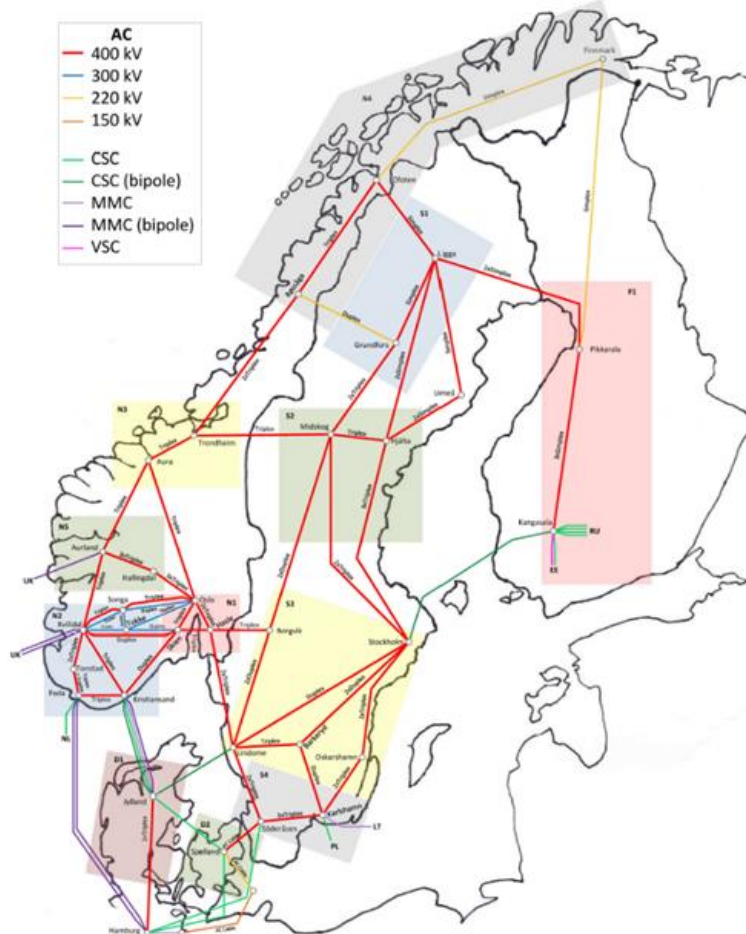

Figure 1: The aggregated model of the foreseen Nordic grid in 2030

Figure 37. Impact of Present and Future HVDC Links on the Nordic Power Grid. (Source: Vrana et al., 2017).

5.2 Wind power plant capabilities for stability support

In Quebec, an event in the synchronous system of Hydro Quebec on 28th December, 2015, caused by a generation loss of 1700 MW caused a frequency nadir of 59.08 HZ on the system. Most wind power plants required to provide inertial response contributed significantly to the recovery of the system frequency (Asmine et al., 2016).

As the share of wind power in the generation mix is growing, wind power plant developers and wind turbine manufacturers are increasingly facing similar requirements as conventional power plants, based on synchronous generators. The

development is not just a 'wind' issue, even though that might be the focus here, as solar photovoltaics and other sources will also need to provide system support services.

The adaptation process of grid codes for wind power plants is not yet complete, and grid codes are expected to evolve further in the future. There is still room for improvement, especially concerning international harmonisation of requirements. The new European network codes leave many key aspects unspecified, referring instead to regulation by the relevant TSO, but they do provide a positive and encouraging step in the right direction.

In (Vrana et al., 2018) some recent developments are discussed:

- High Wind Extended Production is an elegant feature, making the power output of wind power plants more controllable and predictable, reducing power ramping rates, and therefore also the difficulties of power balancing, during critical weather situations.
- An active power frequency response can assist short-term power balancing.
- Inertia emulation is a 'hot topic' for making wind power plants more similar to synchronous generator based conventional power stations. An interesting concept in this context is the virtual synchronous machine, which could be a viable practical implementation for stricter future grid codes, which could contain specifications for dynamic behaviour.
- Harmonics related issues are especially relevant regarding HVDC-connected remote offshore wind power plants, but they are also gaining importance onshore.

An example of validation of stability support providing very fast, inertia-like response required by the Quebec system operator is reported in (Asmine et al., 2016).

5.2.1 Wind power plants and frequency stability

An important thing to notice is that inverter-based controls from wind, PV, batteries, frequency-responsive load can provide faster responses than thermal generators. The studies of frequency stability usually take this into account. Here results from Texas and Western interconnect in the US as well as Mexico are presented.

In Texas, US, System operator ERCOT has conducted simulations to show the benefits of fast frequency response (FFR) over primary frequency response (PFR). FFR in ERCOT is enabled within 0.5 seconds of an event. Figure 38 compares the frequency response of ERCOT to the design-basis event with three combinations of PFR and FFR. The frequency nadir is approximately the same for the three combinations, illustrating that under these high wind, low load conditions, 1,400 MW of FFR provides the same response as 3,300 MW of PFR (i.e., 1 MW of FFR provides the same reliability impact as 2.35 MW of PFR).

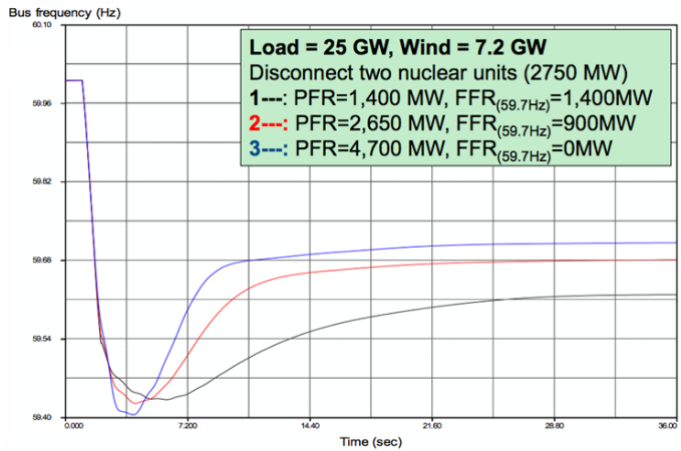

Figure 38. ERCOT frequency response showing 1 MW FFR provides an equivalent response to 2.35MW of PFR, during these high wind, low load operating conditions. (Source: Julia Matevosjana, ERCOT).

The Western Interconnection in the US was investigated in The Western Wind and Solar Integration Study Phase 3. The dynamic performance of with high levels of wind and solar, following a large disturbance was simulated (Miller et al., 2014; Miller, 2015). High instant shares of wind and solar (system non-synchronous penetration SNSP) were studied. Frequency response (both the frequency nadir and settling frequency) was improved with the addition of synthetic inertial and governor controls on wind turbines (Figure 39). It was worsened with high levels of distributed PV that lacked adequate ride-through performance. At 56% system non-synchronous penetration, with over 80% reduction in coal online in the heavy coal region of the northeast part of the Western Interconnection, dynamic performance was acceptable. Increasing SNSP to 66% (with a corresponding reduction of over 90% of the coal online) resulted in system separation. Conversion of three of the offline coal plants to synchronous condensers returns the system to acceptable dynamic performance.

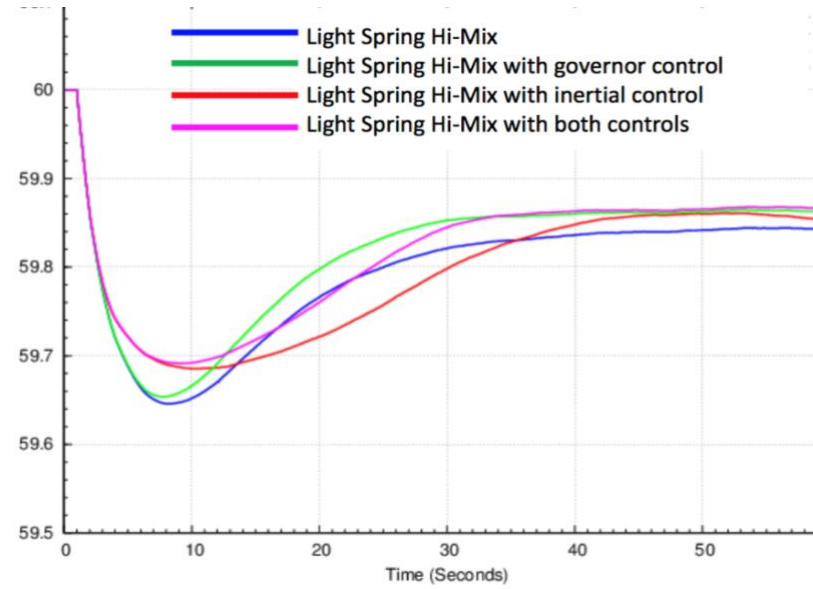

Figure 39 Frequency response to the loss of 2,750 MW in the Western Interconnection with three combinations of frequency controls on wind power plants (Source: Miller et al., 2014).

In Mexico, the simulations show that Inertial and primary frequency control by wind power plants may effectively contribute to dealing with frequency stability challenges under high wind shares in the Mexican Grid (Ramírez-González et al., 2018). Under the analysed scenarios, a curtailment level close to 10% in the output of the considered wind farms was required for this purpose. The improvement in frequency nadir, recovery time and steady state frequency in both an isolated part (wind share 19%) and in the main Mexican Grid (wind share 10%) with synthetic inertia and primary frequency control provided by wind power plants is illustrated in Figure 40.

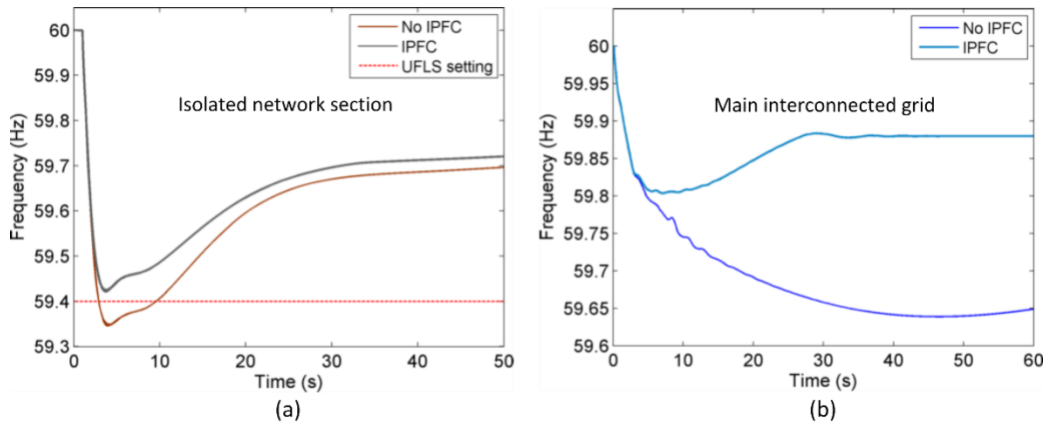

Fig. Inertial and primary frequency control (IPFC) by wind power plants in the Mexican Grid.

Figure 40. Impact of inertial and primary frequency control (IPFC) by wind power plants after an event in the Mexican Grid. (Source: Ramírez-González et al., 2018).

5.2.2 New services for stability support

Advanced ancillary services may be required from wind power plants in the future, when the number of synchronous generators in the system decrease leading to power system stability issues, such as rotor angle stability.

In Denmark, Power Oscillation Damping (POD) and Synchronizing Power (SP) from wind power plants (WPPs) are studied. The typical waveforms for these control functionalities implemented in WPPs are shown in Figure 41.

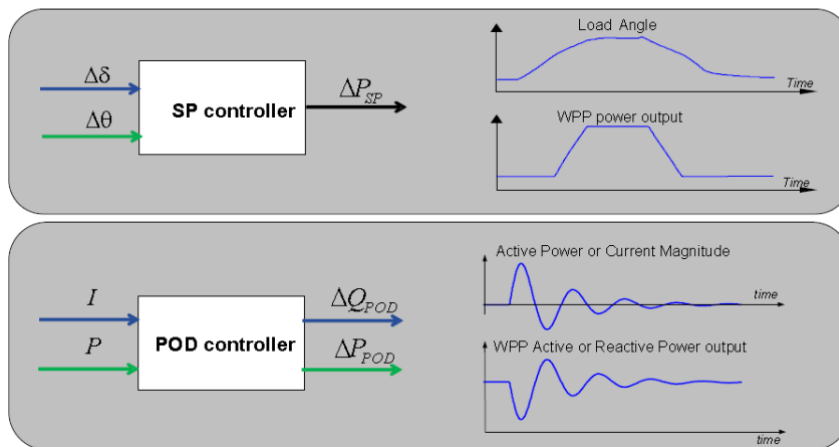

Figure 41. Typical in/out waveforms overview of the new control functionalities from wind power plants, for Synchronising power (SP) and Power Oscillation Damping (POD) (Source: Sakamuri).

Power Oscillation Damping

Wind power plants can be used as a damping device for the power oscillating in a power system- similar to the Power System Stabilizers (PSS) in the conventional power plants. A WPP may be used as a damping device by modulating either active or reactive power output. The input to the power oscillation damping (POD) controller can typically be a signal which reflects the power system oscillations. Two input signals, i.e. current magnitude and active power flow, have been used in (Hansen et al., 2015). The simulations conclude that WPPs can contribute with POD control functionality. However the tuning of the POD control parameters is very important and dependent on the input/output pair combinations and the input measurement location (remote or local). In addition, if multiple WPPs are required to provide POD at the same time, a coordinated POD parameter tuning between WPPs (by TSOs) is crucial for the small signal stability of the power system even with the conventional power plants' PSSs.

Synchronizing power

Synchronizing power (SP) is an embedded feature of synchronous generators (SG), which reduces the load angle between groups of SGs. If the load angle becomes too high, the SGs lose torque and system becomes unstable. The idea of SP from WPP, is to improve the steady state stability of the power system by giving additional power into the system from the WPP, in cases when the rotor angle rises above a safe limit. Typically the change in rotor angle is determined by a load change. Based on the rotor or voltage angle deviation the SP controller increases the active power output of the WPP and thus compensate with active power the lack of SP in the system (Hansen & Altin, 2015).

One way of designing a SP controller is to use as input signals (assuming their availability): either the rotor angle difference between two synchronous generators or the voltage angle difference between two bus bars (Hansen & Altin, 2015). Based on the simulation results, presented in detail in (Hansen & Altin, 2015), the SP functionality can be provided by WPPs.

5.3 Operating reserves

Power systems balance to total load and generation in a balancing area with operating reserves. Wind power imbalances will be merged with other imbalances in the power system. Operating reserve for balancing and frequency control is divided to several time-scales of response – with a very general division we can talk about automatically activated reserves (in time-scale of seconds) and manually activated reserves (in time-scale of 10 minutes or so). This section summarises the experience and studies regarding allocation and use of operating reserves for systems with high shares of wind power. Wind power can also provide operating reserves – this is described in Section 5.2.2.

5.3.1 Experience on operating reserves in regions with high shares of wind power

As reported in previous summary reports (Holtinen et al., 2016a), increasing amounts of wind power will increase the operating reserve requirements, and their use. However, recent experience on decreasing reserve requirements has also been reported, mainly due to changes in operational practices.

In Germany the benefit of sharing balancing responsibility between the four system operators has been much larger than the increase wind and solar impact has been on their system (Kuwahata & Merk, 2017). The dramatic decrease is shown in Figure 42.

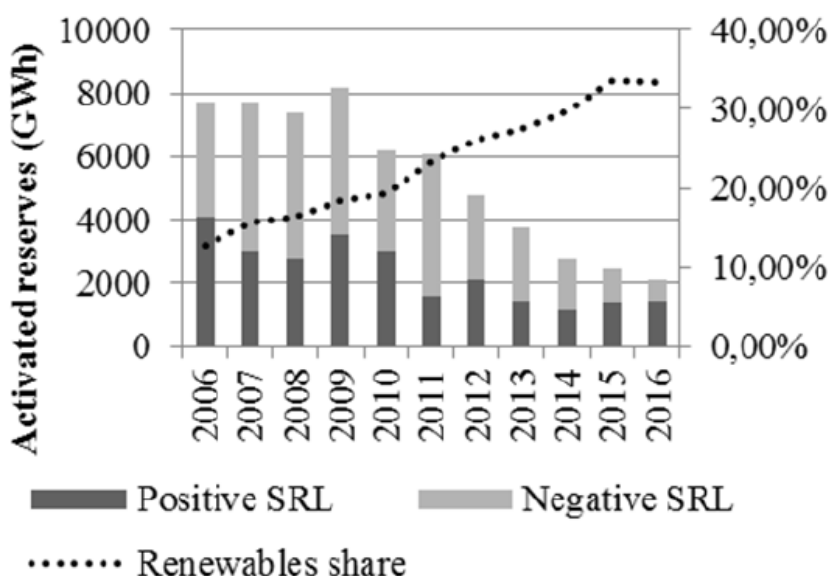

Figure 42. Decrease of secondary reserve activation (SRL) in Germany. The increase of share of renewables is also shown. (Source: Kuwahata & Merk, 2017).

In Texas, the main driver for decreased reserve requirements was the transition from a 15 minute zonal to a 5 minute nodal market in 12/1/2010. The decrease is shown in Figure 43.

Interestingly, there is another effect reported from ERCOT, due to the fast response available from wind power plants providing frequency support: as wind capacity has continued to increase, regulation reserve requirements have continued to decline (Figure 44). Note that in mid-2017, up-regulation requirements had decreased further to 350-400 MW (wind capacity almost 19 GW). ERCOT finds a significant impact from introducing the requirement that all generators be retrofitted if possible to provide primary frequency response (governor response). Wind plants

always provide over-frequency response when they are operating (i.e., they curtail if frequency is high) but they only provide under-frequency response if they are curtailed for some other reason (i.e., they are not pre-curtailed specifically to provide the up-response but rather will provide the up-response if they are curtailed because of over-supply reasons).



Figure 43. Up-regulation reserve requirement in ERCOT (blue) and total wind power capacity in ERCOT (red). (Source: The University of Texas at Austin energy institute, 2017)

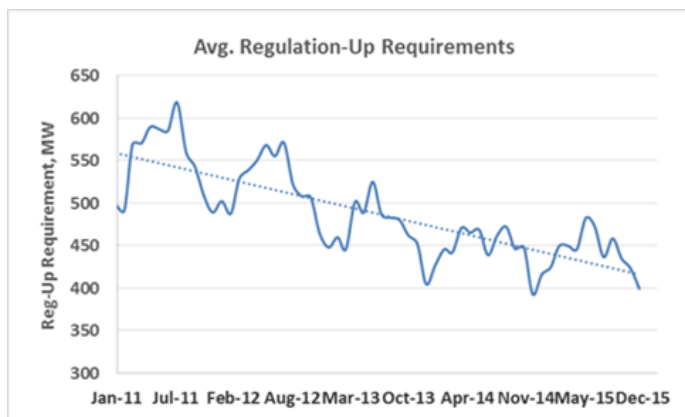

Figure 44. Average up-regulation requirements during 2011–2015 for ERCOT, Texas. The cumulative wind capacity during increased from 9.4 to 15.8 GW in the same period. (Source: Julia Matevosjana, ERCOT).

In Italy, the system operator Terna implemented special pilot projects for testing capabilities and constraints of potential ancillary services by Electrochemical Energy Storage Systems (EESS), authorized by National Regulator Authority. A 35 MW of energy intensive storage programme is for mitigating grid congestions (e.g. energy/power ratio of about 8 hours using NaS technology batteries) operating under remote control and connected to the 150 kV southern part of the national transmission grid with frequent grid congestions caused by an excessive

concentration of wind and solar energy. A 40 MW “power intensive” storage-system installation programme (e.g. energy/power ratio between 0,5 and 4 hours using SoNick and Li-ion technology batteries) is exploiting the potential offered by the rapid response times of storage systems to increase the operating security margins of the high voltage grids on the islands of Sicily and Sardinia. The total P output (FCR regulation) triggered by the EESS installed in Sardinia against a deep frequency transient is depicted in Figure 45. Congestions relieve and active power balancing service is used to set a specific active power profile to Electrochemical Energy Storage Systems EESS (either single device or equivalent aggregated) through a XML file or via a manual set-point. As long as this service is activated, other activated power regulations (frequency support services FCR and FRR) shall perform following this active power profile.

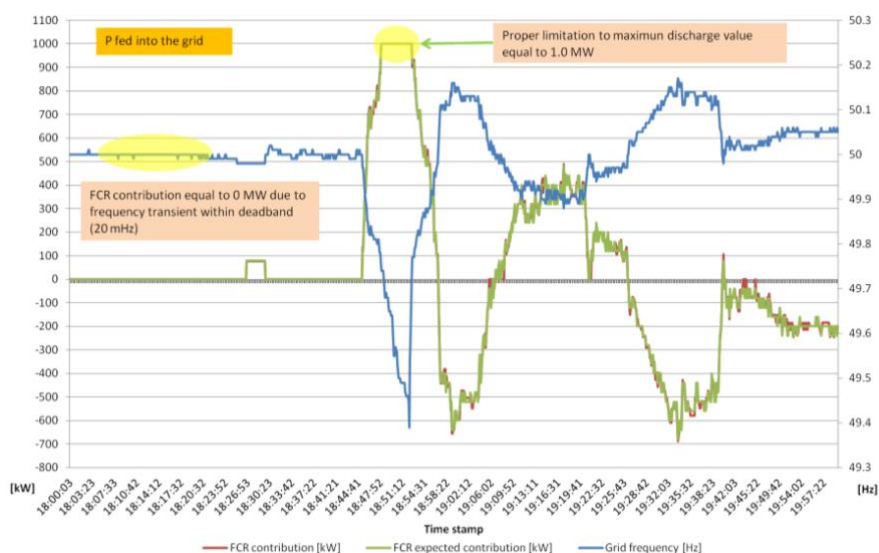

Figure 45. Electrical Energy Storage performance for fast frequency support (FCR contribution): total P output against a real frequency transient (Source: Terna).

5.3.2 Estimating requirements for operating reserves

The prevailing practice in integrating variable renewables is to procure a certain amount of reserve to compensate for the uncertainties of net-load. Such reserves are mainly affected by demand, wind and solar forecasting errors and unplanned outages of thermal groups. In this sense, the quality of the wind and solar forecast has great influence on both the reliability and operation efficiency. To procure excessive reserve leads to inefficient operation, while an inadequate amount of reserve could result in a potential reliability issue. However, as the wind and PV forecast errors are time-varying, some judgment should be applied to determine an

appropriate trade-off between the economics and the risk management. Dimensioning operating reserves with the help of deterministic criteria that determine the capacity for a long period (several months) work out quite well with traditional power systems. However, increasing shares of variable generation introduce higher volatility to future power systems which leads to a more volatile need for balancing.

In Texas, ERCOT has added a Reliability Risk Desk in the control room. This has greatly increased the visibility and management of renewables, and introduced risk-based methods to determine reserve requirements. At ERCOT, the volume of the reserve is sized based on the net-load forecast errors with a confidence level assigned as a function of the net-load ramp magnitude. As seen from Figure 46 a large amount of wind generation greatly exaggerates the forecast error of net-load at ERCOT.

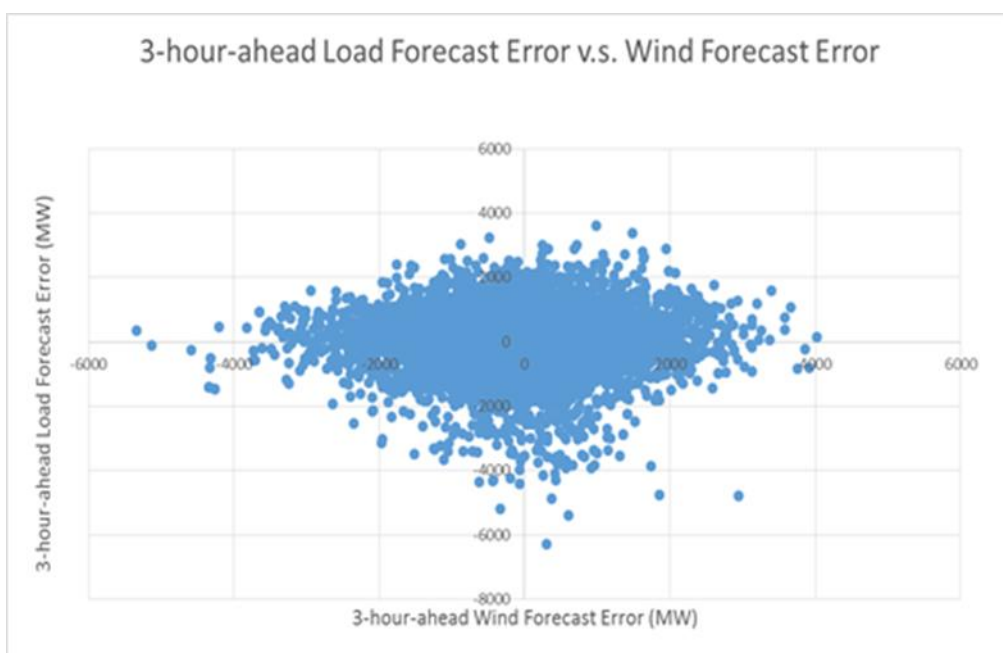

Figure 46. ERCOT 3-hour ahead load forecast error versus wind forecast error in 2016.

In Canada, the impact of 20 and 35% wind share on operating reserves was estimated in the Pan Canadian Wind Integration Study. Chronological production simulations at an hourly resolution, as well as 10-minute load data for statistical characterization of the 10 individual balancing areas (provinces) were used in the study. Load alone and net load regulation reserve volumes for each Canadian balancing area were compared. The incremental increases in regulating reserve ranged from 0.7–1.7%; in other words, for each 1,000 MW of additional wind

capacity, between 7 and 17 MW of additional regulating reserves would be required, nationally. The largest increase in regulating reserve capacity was observed in Saskatchewan, and the smallest increase was observed in Quebec (Table 6).

Table 6. Estimates for increases in reserve requirements (RR) for Canadian provinces from Pan Canadian Wind Integration Study (BC British Columbia, AB Alberta, SK Saskatchewan, MB Manitoba, ON Ontario, QC Quebec, MAR Maritime provinces).

5% wind	BC	AB	SK	MB	ON	QC	MAR	Total
Wind Capacity MW	685	1,438	450	258	4,101	2,959	1,074	10,966
Increase RR as % of new wind capacity	0.4%	1.5%	1.6%	1.8%	0.7%	0.2%	0.7%	0.7%
20% wind	BC	AB	SK	MB	ON	QC	MAR	Total
Wind Capacity MW	4,269	6,944	1,748	1,781	8,438	12,274	1,673	37,127
Increase RR as % of new wind capacity	0.8%	2.4%	3.9%	3.5%	1.2%	0.8%	1.1%	1.5%
20% wind	BC	AB	SK	MB	ON	QC	MAR	Total
Wind Capacity MW	2,221	9,840	914	2,789	10,054	6,127	4,361	36,307
Increase RR as % of new wind capacity	0.7%	2.5%	2.3%	3.1%	1.3%	0.5%	1.7%	1.7%
35% wind	BC	AB	SK	MB	ON	QC	MAR	Total
Wind Capacity MW	5,445	17,728	4,406	2,213	16,122	15,489	3,819	65,221
Increase RR as % of new wind capacity	0.9%	2.4%	3.2%	3.4%	1.2%	0.8%	1.6%	1.6%

In Nordic countries, the impact of aggregation benefits of wind power forecast errors on reserve requirements were shown to be strong both for shortening horizons and increasing balancing area size. The analyses show that the reserve requirements, as increase in existing hourly imbalances due to adding wind power, are double when day-ahead forecast errors are used compared to intra-day 1 hour ahead forecasts. The requirements also double if Finland forecast errors are used compared to Nordic wide forecast errors (Figure 47) (Miettinen & Holttinen, 2018).

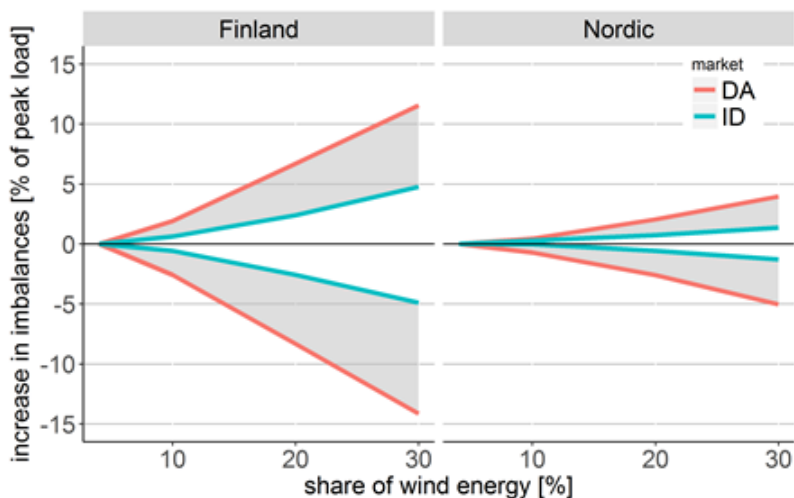

Figure 47. Increase in the real-time net imbalance need for increasing wind shares, for 2011 data (Source: Miettinen & Holttinen, 2018).

In Germany, a new method for dimensioning of reserve was introduced (Jost et al., 2015). This method uses quantile regression based on artificial neural networks (ANN) to forecast the reserve capacities to meet the security level striven. The method was tested for the day-ahead dimensioning of frequency restoration reserve capacities in Germany (Figure 48), and compared to a static ex-post dimensioning results that (1) have the same loss of time (% with insufficient reserve capacity), (2) have the same average reserve capacity and (3) meet exactly the loss of time target. The dynamic dimensioning shows advantages concerning all criteria for both negative and positive FRR. Compared to the static dimensioning for the loss of time target, the average scheduled reserve capacity as well as the loss of time is less. Furthermore, remaining imbalances are smaller in average but also in regard to the maximal power losses.

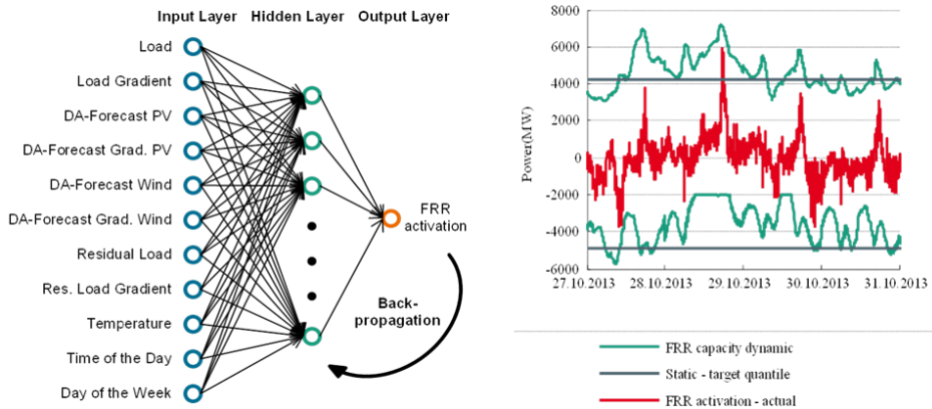

Figure 48. Left: Schematic illustration of the ANN used to dimension the reserve; right: example for dynamic FRR capacity dimensioning result for ANNs with 8 neurons in the hidden layer (Jost et al., 2015).

An extension of the dynamic sizing method enables the approach to be utilized for actual reserve sizing by German TSOs (Jost et al., 2016). The first improvement is the adaptive bias correction function, allowing the latest events to be covered and considering long-term trends regarding the balancing needs. The right amounts of reserve capacity can be procured more exactly to meet the security levels striven. In the case of long-term changing balancing need (like the decreasing trend in Germany in 2012 and 2013) the adaptive bias correction function leads to more appropriate capacities.

Allocating the reserves to automatic (aFRR: activated automatically by a load-frequency-controller with an activation time of 5 minutes) and to manual (mFRR: activated manually by the control room staff with an activation time of 15 minutes) can also be improved. Some reserve sizing approaches, like the German Graf-Haubrich method, assume that some errors (like load forecast errors) can be balanced entirely by mFRR, whereas others (e.g. fluctuations) have to be balanced by aFRR (Maurer, 2010). This approach leads to nearly equal aFRR and mFRR capacity tendering. In Jost et al. (2016) the allocation of total FRR and aFRR is done separately. The difference between FRR and aFRR is then procured as mFRR. Results show that mFRR only plays a minor role compared to aFRR. This result is contrary to today's reserve sizing practice where roughly the same capacities are tendered for aFRR and mFRR, but it is consistent with today's mFRR activation practice. This is due to the fact that mFRR is activated only if the control room staff can assume that there will be a certain imbalance over the whole next quarter hour which is not considered by the today's applied sizing method.

The dynamic sizing method can also be extended to calculate constant reserve capacities for longer product lengths. This is important due to the fact that TSOs cannot tender different amounts of reserve capacity in every minute, but rather for hours. Calculating those reserve needs is possible by averaging the 1 minute results

over the product length. To meet the striven security level the bias is corrected afterwards. The results show that short product lengths allow more accurate sizing of reserve capacity which is also lower in average. For product lengths up to one hour nearly no difference to one minute can be observed. Longer product lengths lead to significantly more reserve capacity with even lower security levels.

In Japan, a new method using analogy of capacity adequacy assessment method (loss-of-load probability/expectance LOLP/LOLE) has been derived: LORP, Loss Of Reserve capacity Probability (Tanabe et al., 2017). The method can assess the adequacy of reserve capacity for the duration curves on the magnitude and speed of net-load ramp. Weekly/daily duration curves of the magnitude and speed of net-load ramp (i.e., occurrence probability of each necessary flexible capacity level) are produced. An example of applying it to solar ramping and pumped hydro flexibility is given in Figure 49.

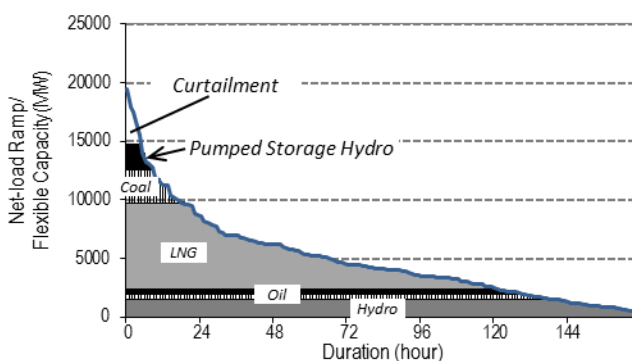

Figure 49. Flexible Capacities for Net-load Ramp (April 29-May 5). (Source: Tanabe et al., 2017).

6. Maximizing the value of wind power in operations

The value of wind power will be maximised when there is no need to curtail any available power, and when the impacts to other power plants in the operational time-scale are minimised. In addition to experience and results of curtailments and balancing, this section describes measures to enhance the balancing task with high shares of wind power: operational practices and markets, storages, demand side flexibility and combining electricity with heat flexibilities.

6.1 Curtailments

Curtailed wind generation is one metric showing how well wind power can be accommodated by the power system. Reduction of available wind energy can be used in critical moments when there is a surplus of energy and no other means to absorb the energy by the power system. There is experience on curtailments from several countries. Curtailment is a significant challenge for renewable energy integration into weakly interconnected systems (like Ireland and the Iberian Peninsula) or where grid infrastructure is lagging behind the development of wind power plants (Germany, China) or a large number of conventional generators have must-run obligations making the supply side very inflexible (China, Japan).

Wind curtailments are also often calculated from wind integration study simulations for power system dispatch, showing the challenges of wind integration (Bird et al., 2016). Curtailment of wind energy evaluated in the Pan Canadian Wind Integration Study was modest: about 6.5% to 6.9% energy curtailment with 20% wind penetration in Canada. The amount of curtailment is higher in the scenarios with more wind energy, and is primarily due to transmission congestion. In addition to building transmission, options for reducing curtailment in Canada include shifting hydro power usage where large hydro reservoirs allow for storage capacity to be used and providing more operational flexibility in thermal generation.

There are various approaches to curtailing, ranging from manual curtailment to more automated approaches. Where balancing responsibilities exist and balancing markets are open to all participants curtailment can be understood as a service to the system by dispatching down power output. The service of dispatching-down power (downwards regulation) can be offered through the balancing market. Today, most wind power plants have the capability to provide downwards regulation (in line with national grid codes). Downward regulation by wind producers is already offered in the Danish, British and Spanish balancing markets. In the USA, MISO, ERCOT, and NYISO also use these market mechanisms. From an economic perspective, the main difference between production curtailment for system balancing and the provision of downward regulation is that, in the former, generators are generally settled at a regulated remuneration (i.e. percentage of the day-ahead market price), while downwards reserve providers are settled at the balancing market price. Deciding to dispatch-down wind power when wind resources are available is a lost

opportunity (at a zero marginal cost since no fuel is used). The revenue from the balancing market is likely to compensate for the price in the market (day-ahead or intraday) but will not reflect the value of the premium which many wind power generators still receive from Feed-in-Tariffs or Feed-In-Premiums. The regulated curtailment remuneration does not reflect the real time balancing cost, and thus it does not send the right price incentive. Some incentive systems consider the surplus generation situations from system operator point of view and wind generators are not paid any subsidies during the hours when day-ahead prices go to zero, incentivising also wind power plants providing downregulation (Finland).

6.1.1 Curtailments in Europe

An overview of curtailment rates in Europe in 2017 is provided in Figure 50.

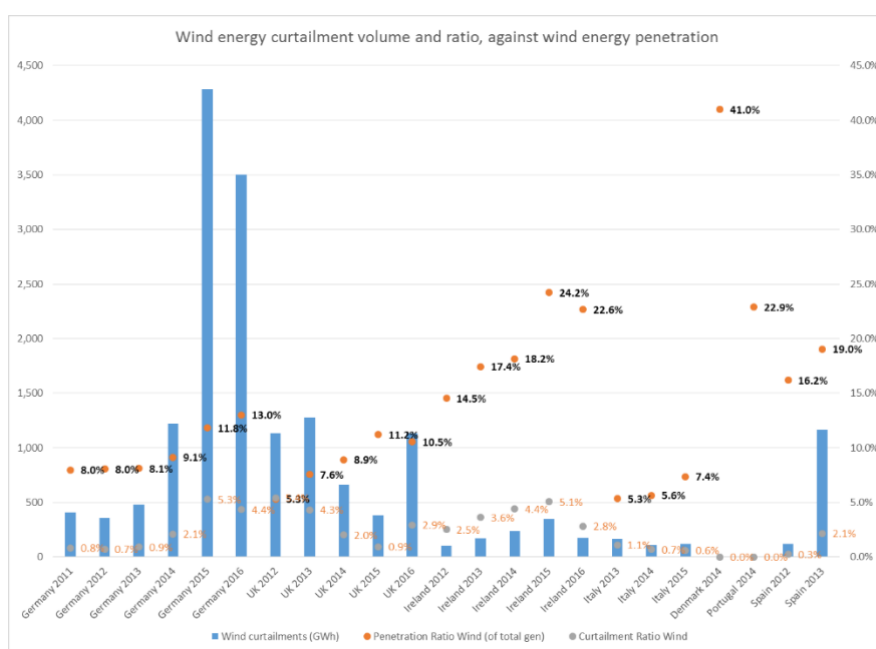

Figure 50. Wind energy curtailment in Europe - volumes in GWh and % of total wind generation. The wind share in total electricity consumption (%) is also presented. (Source: WindEurope).

The recent trend of curtailment in European countries as a “curtailment map” is presented in Figure 51, mapping the trend of curtailment in each area with curtailment ratio as function of penetration ratio (Yasuda et al., 2015). In Germany, Ireland and Spain the curtailments have gradually increased in recent years, even there is decline in 2016 (a low wind year). Italy and UK have successfully improved

undesirable situations except of the latest deterioration in UK. Denmark and Portugal still keep zero-curtaiment despite of their high share of wind.

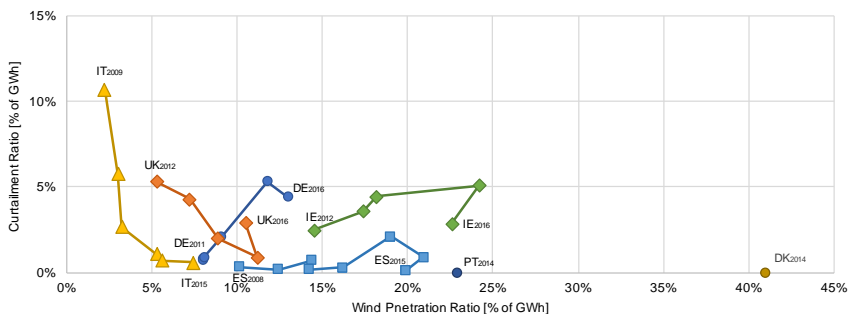

Figure 51. Wind energy curtailment in Europe – curtailment map (Source: WindEurope, Yasuda et al., 2015).

In Germany the delays in grid reinforcements have resulted in increasing re-dispatch measures (re-dispatch is a measure used by system operator to manage grid congestion through purchase of power in deficit area and downregulation in surplus area). Although year 2016 saw some reductions compared to year 2015, this was mostly due to less than average wind resource and the trend is still increasing. In 2016 the total re-dispatched energy was 11,475 GWh, compared to 15,436 GWh in 2015 (decreases for generation total 6,256 GWh and increases 5,219 GWh). The amount of renewable energy curtailed as a result of feed-in management measures also decreased from 4,722 GWh in 2015 to 3,743 GWh in 2016. This corresponds to 2.3% of the total amount of renewable energy generated, compared to 2.9% in 2015. The sum total of compensation payments increased significantly from €315m in 2015 to €643m in 2016. In total, claims for compensation from RES facility operators for 2016 are estimated at €373m. The discrepancy between the figures is due to the fact that the compensation paid in 2016 does not reflect the compensation for energy curtailments in 2016 but also includes real compensation paid for curtailments in previous years. The amount of €373m that has to be paid to the operators is only estimated based on the amount of the curtailed energy but it is not completely paid in 2016. In 2016, as in the previous years, feed-in management measures primarily involved wind power plants, accounting for 94.4% of the total amount of curtailed energy, up from 87.3% in 2015. Solar was the second leading energy type affected in 2016 by curtailments, with a share of almost 5%. Currently there are no official values about curtailments in Germany published by (Bundesnetzagentur, 2018). Based on own estimations the firm UBIMET estimated about 5.5 TWh curtailed energy in 2017. As visible in Figure 52 the main part comes from curtailed onshore wind energy (~4.5 TWh).

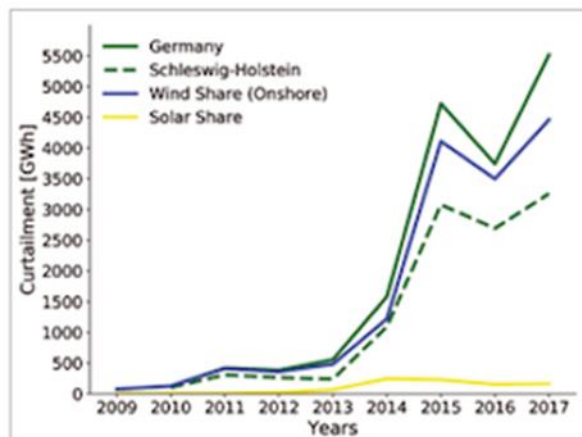

Figure 52. Development of Curtailment volume in Germany. (Source: <https://www.ubimet.com/einspeisemanagement-einfluss-auf-marktpreise-und-regelenergie-themenmagazin/>).

In Ireland, wind power curtailment was recorded at just under 4% for 2017. EirGrid is mandated to produce annual renewable curtailment reports breaking down curtailment by cause, region, month and year. Figure 53 shows curtailment for the whole island of Ireland from 2011 to 2017 broken down by primary cause. The two high level causes are transmission congestion, associated with delays in building transmission reinforcements associated with wind power projects and system constraints. System constraints include the system non-synchronous penetration (SNSP) limit and constraints such as high frequency run-back and minimum stable generation constraints. The SNSP constraint was introduced into Ireland in 2011 as a result of studies suggesting stability problems at high instantaneous shares of wind power. This was originally set at 50% but has since increased to 65% in November 2017. This increase in SNSP has somewhat offset increased curtailment that may have results from increased wind capacity over the same period (EirGrid & SONI, 2018).

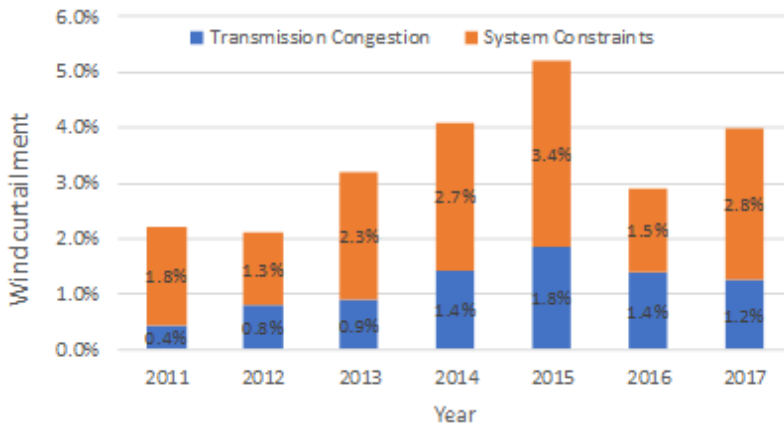

Figure 53. Wind curtailment by year and region for the island of Ireland. (Source: EirGrid & SONI, 2018). Wind power capacity increased from 1.6 to 3.6 GW (15 to 25% of annual demand) from 2011 to 2017.

6.1.2 Curtailments in US

Curtailment map of some of the Regional Transmission Operator (RTO) areas in the U.S. is shown in Figure 54. Although the ERCOT marked undesirable curtailment ratio over 15% in past, the area shows decreasing trends in the historical curve, due to the gradual completion of transmission lines in the CREZ scheme. The reason for MISO's circular trend is that the jurisdiction of MISO has recently enlarged and the share of wind in the area has relatively decreased. The MISO's latest trend shows reduction in curtailment.

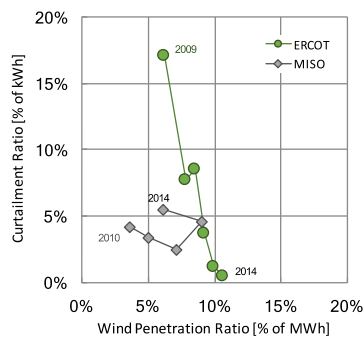

Figure 54. Curtailment map of some RTOs in U.S. (Source: Yasuda et al., 2015).

6.1.3 Curtailments in China

In China the average utilization rates of the power units have been declining year by year. Wind power is curtailed mainly due to the poor flexible adjustment capacity of power generation side, the underdeveloped interconnected transmission grids, and the limited demand response capacity of demand side. Figure 55 shows the curtailment map of whole of China as well as the provinces with high wind share.

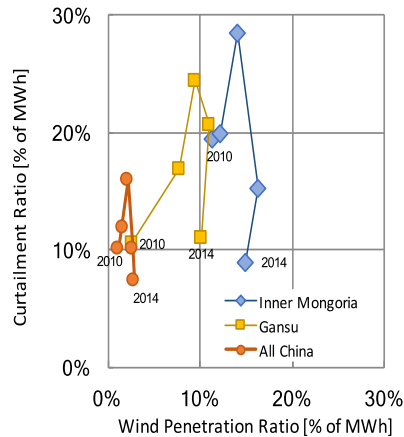

Figure 55. Curtailment map of China. (Source: WindEurope, Yasuda et al., 2015, National Energy Administration in China, 2014).

6.2 Using wind power plants for frequency support services

The grid needs essential reliability services to operate reliably. During hours of high wind and PV penetration, and fewer synchronous generators online, it is important that either the wind and PV provide essential reliability services or risk being curtailed to commit a synchronous generator than can. Services may include synthetic inertial response as discussed in previous Section 5.2.1 (IESO, Hydro-Quebec require synthetic inertia from wind already) or voltage control.

Wind is also already providing frequency support services, for the different time scales (primary/secondary/tertiary) in several places.

6.2.1 Primary frequency response

Primary Frequency Response PFR responds to Frequency containment reserve FCR in Europe. Wind and PV need to be pre-curtailed to provide the up-response (under-frequency). If they are operating, they can always provide the down-response (over-frequency). ERCOT, Hydro-Quebec and IESO require primary frequency response from wind (see also 5.3.1). Ireland requires a similar capability,

and its capability has been demonstrated in qualification trials for the timeframe from 2 s to 5 minutes, encompassing fast frequency, primary, secondary and tertiary reserve timeframes. Note that wind and PV can provide more aggressive than the typical 5% droop response. There may be times when the system operator needs a more aggressive response. Wind/PV should be allowed to provide this, and should be compensated for it.

In addition to operating wind power plants in de-loaded mode to provide grid support services, a fast active power increase in case of a frequency event can be provided making use of the rotational energy stored in the moving parts of the wind turbine. The basic idea is to extract – for a limited period of time – an active power that is larger than the available power in the wind speed. During this, naturally, the wind turbine will slow down and when the control is released, the power output from the wind turbines will drop below the available power level, due to the need of the wind turbine to accelerate back. Ways of minimizing this recovery period – either by limiting the release or by modifying the wind turbine control – were investigated with good result in (Sakamuri et al., 2017). Figure 56 shows some of the results.

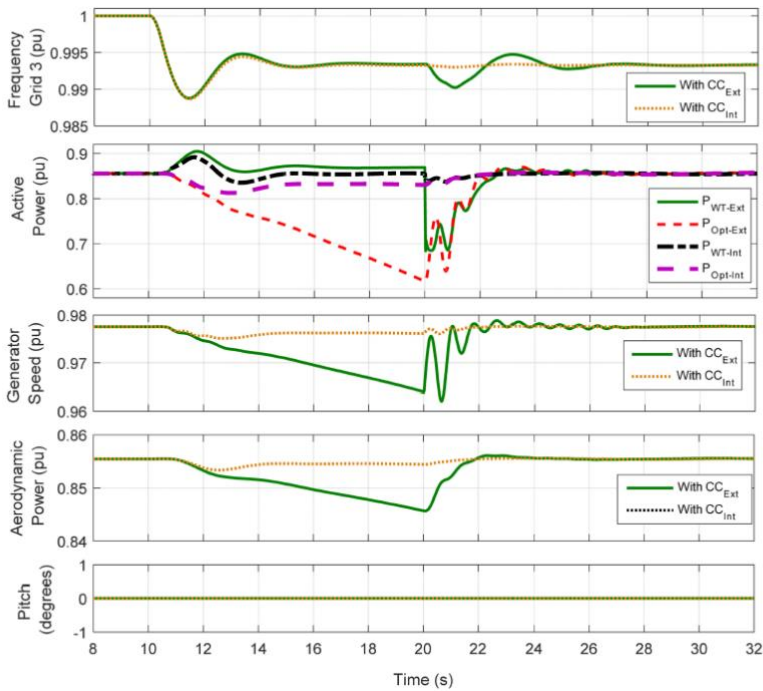

Figure 56. Impact of overloading method on wind turbine dynamics (Source: Sakamuri et al., 2017).

6.2.2 Regulation/AGC/Secondary Response

Wind and PV need to be pre-curtailed to provide up-regulation. If they are operating, they can always provide down-regulation. Markets with a single, symmetric regulation product can therefore be a barrier to this provision.

In Colorado, US wind power plants may provide both up- and downregulation when curtailed. Sometimes at night, Xcel/PSCO has excess supply so they have wind provide up and down regulation reserves (Figure 57). Xcel has over 2,172 MW of wind capable of providing regulation when needed.

In California, a test of a PV plant in CAISO following a regulation signal showed that PV can follow a regulation signal more accurately than conventional generation (Table 7).

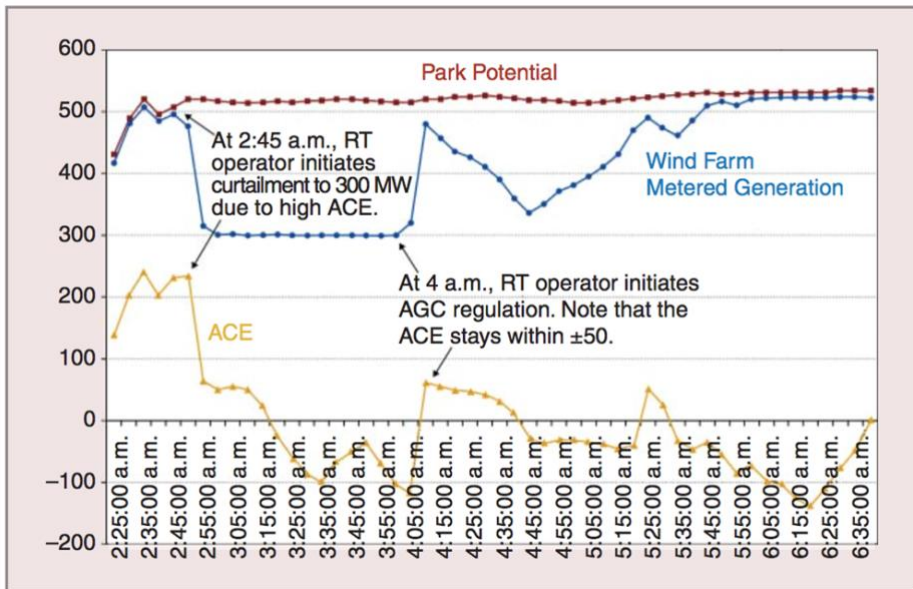

Figure 57. Wind power plant in Xcel/PSCO is first manually block curtailed and then put on AGC regulation. Y-axis is MW. Resulting area control error is shown in yellow. (Source: Drake Bartlett, Xcel).

Table 7. Typical up-regulation accuracy of CAISO conventional generation compared to measured regulation accuracy of 300 MW PV plant in CAISO, depending on time of day.

	Gas combined cycle	Gas turbine	Hydro	Battery	Pumped storage turbine	Steam turbine	300 MV PV plant
Accuracy	46.88%	63.08%	46.67%	61.35%	45.31%	40%	87.1%– 93.7%

In Canada, tests undertaken at the Wind Energy Institute of Canada (WEICan) have demonstrated similar up and down-regulation capabilities. Two studies were undertaken using 30 minutes and 4.5 hours of historical 2 second AGC signals (updated each 4 seconds) provided by the Alberta Electric System Operator (AESO). The 10 MW wind power plant (WPP) was dispatched against the AESO AGC signal under both constant (e.g., operating “above the knee” on the WPP power curve) and varying (e.g., operating “below the knee” on the WPP power curve) power generation levels. 1 MW of regulation was offered. The results of the test (Table 8 and Figure 58) provide a “Performance Score”, which represents how well a regulation resource can follow the AGC set-points. The Performance score denoted as (η) is a number between 0 and 1 (or 0 and 100%). The performance score quantifies how well a generator’s output follows the AGC set-points. However, currently, there is no general consensus on how performance score should be calculated. The performance score calculation in this report is aligned with the score calculation done by National Research Council Canada for AESO for conventional generators.

Table 8. Results for compliance test for AGC, based on a performance score using a scoring method developed for PJM market, as well as a method developed by the National Research Council for the Alberta Electric System Operator.

	NRC η^a	PJM η
Below rated power	78%	64%
At rated power	96%	74%
Net	81%	65% ^a

a) Since NRC’s scoring method was designed for conventional generators, it includes a gap between the AGC setpoints and the dispatch value. The calculation results here account for this gap.

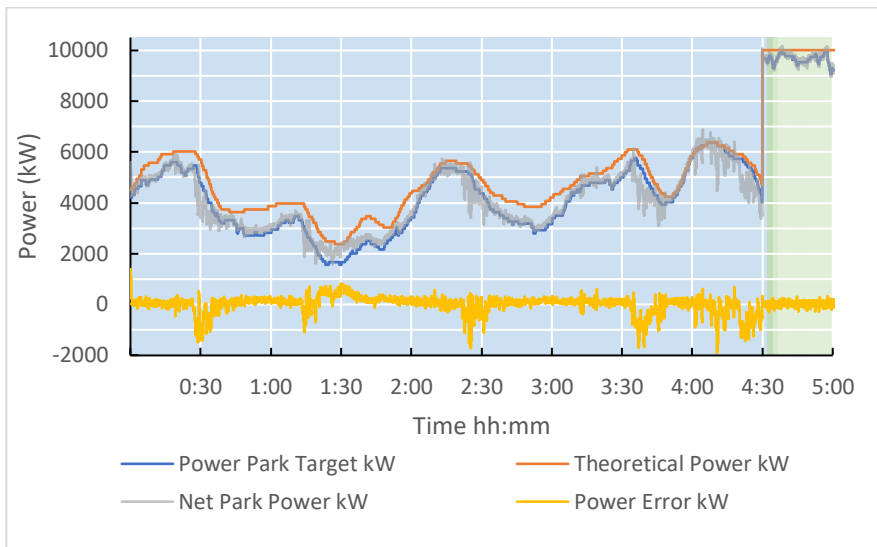

Figure 58. Combined test results: Blue region: Below rated power; Green region: At rated power (both performed at different times).

6.2.3 Tertiary/balancing services with 10...30 min response time

In Nordic countries, the market rules of manually activated frequency response (Regulation power market) enable also wind power plants to take part - they have been used some times in Denmark.

In Spain, the procedures to allow wind power to participate in balancing services were given December 2015. Participation started on 10 February 2016, and by the end of 2016, 5.7 GW of wind power, representing 25% of the total installed wind power in Spain, had successfully passed the Operational Capability Tests (OCTs) for Imbalances Management and Tertiary Reserves services. About 14 GW of the total of 23 GW wind power capacity installed in Spain had passed these tests by December 2018 (10 GW by July 2017). Wind power has a considerable contribution, especially in Tertiary Reserves, with an hourly participation that have reached -1911 MWh and 350.3 MWh for downward and upward respectively. In comparison with the rest of technologies in Tertiary Market, for downward reserves wind energy accounts for 3.6% in 2016 and 6.1% in 2017 of the total and for upward reserves, wind energy contribution is lower than downward reserves, with 0.73% in 2016 and 2.55% in 2017 (see Figure 59 for the tertiary reserves contribution of every technology).

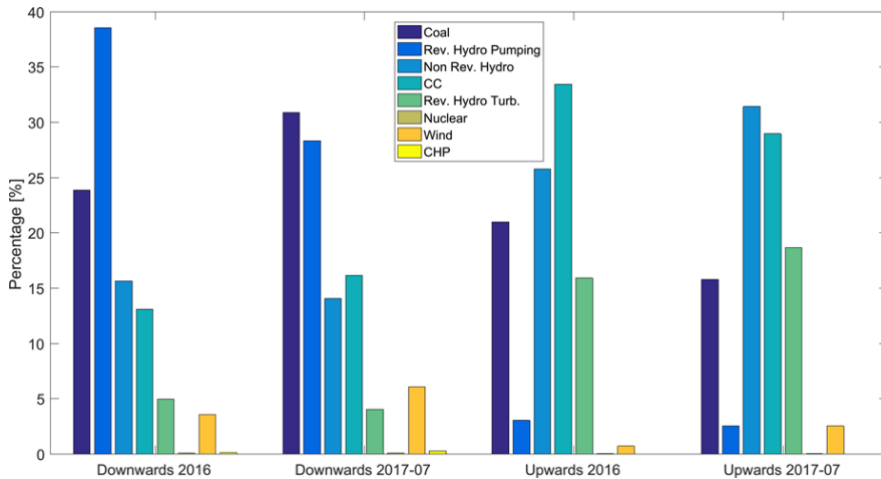

Figure 59. Contribution of generation technologies to tertiary reserves in the Spanish power system. Yearly analysis for 2016 and 7 months for 2017.

The Operational Capability Tests (OCTs) are conducted based on the generation schedules, fulfilling the adjustments assigned with a certain response time: 15 min for Tertiary Reserves and 30 min for Imbalances Management. The OCTs determine the regulation capability of the physical units, considering the primary energy available to establish the maximum power. The first OCT that the generation units perform is called the “ramp test”. Once this ramp test has been conducted, the TSO will establish the minimum rising and falling rate of the physical units for 15 min to contribute to Tertiary Reserves, and for 30 min to Imbalances Management. The second OCT is an instruction monitoring test from the TSO. This test will be conducted within 72 hours with the TSO sending power set point commands to the generation unit to check the results of the ramp test. Renewable Energy Sources must ensure that they will provide, at least, 10% of the maximum energy for that period (i.e., 10% of the energy if the power plant is working at nominal power for 72 hours).

In the US, the ability of wind power to play in the new flexibility reserve markets in the Midcontinent Independent System Operator and the California Independent System Operator to help balance minutely-to-hourly variations in load and generation, has become an interesting topic of research. Initial research has been into the times when wind might be able to provide this flexible ramping product through increased accuracy in the modelling of wind ramping events, and the implications for power system operations. Studies in test systems have shown both potential economic and reliability benefits from allowing wind to participate in such reserve markets through the creation of wind power ramping products (Cui et al., 2017). This provides not only a system-level benefit, but a potential new revenues stream for wind power in market environments with high shares of variable generation (Figure 60).

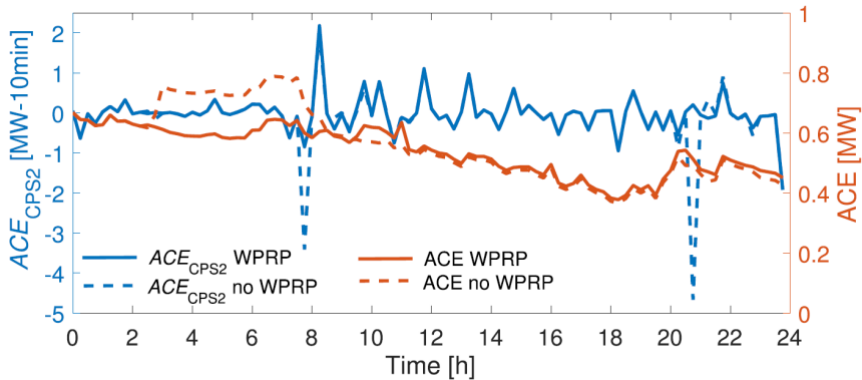

Figure 60. System reliability is improved using wind power frequency support services, as is seen from lower ACE (Area control error) values simulating with and without 10 wind power plants offering services (IEEE 118-bus test system) (Source: Cui et al., 2017).

6.2.4 Barriers for integrating wind power to markets

In the US, barriers for using the grid support services are:

- lack of information. Utilities and regulators are often unaware of the essential reliability services that wind can provide, and think that conventional generators are the only sources of those services. Therefore they don't set up requirements for advanced functionality. Or perhaps they don't set up markets for those services or don't change rules to allow wind to play in those markets.
- wind industry focus on energy. As wind penetrations increase, and wind is increasingly curtailed, this focus will shift away from energy and towards non-energy services such as reserves. These revenue streams will become increasingly valuable. If the policy and regulatory frameworks allow for wind to provide to provide these non-energy services, wind will shift towards providing them.
- revenue streams. Requiring advanced functionality may not 'pay' for those features. ERCOT, for example, required wind retrofits for primary frequency response and there was no additional revenue stream or funding to pay for those retrofits. Another approach would be to establish a market for primary frequency response and allow wind plants to determine whether retrofits were economically justified. Additionally we note that because wind may provide better performance than conventional generators (faster frequency response, a more aggressive response, or more accuracy in following a regulation signal) and that this performance should be rewarded in the marketplace.

6.2.5 Increased value for wind power from markets

For day-ahead market design, the impact of using shorter gate closure time, aggregating wind turbines/power plants and forecast bidding strategies using probabilistic forecasts allows increasing the wind energy value to the market to values close to a hypothetical “Perfect Forecast”. This will reduce the difference between feed-in-tariffs and market revenues or even the need for incentives, as Contract of Differences (CfDs) or market premiums (Figure 61.).

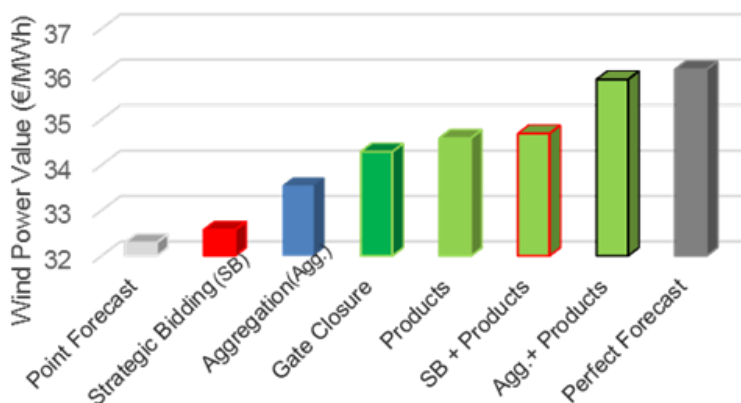

Figure 61. Increasing wind energy value to the market using different approaches: strategic bidding based on probabilistic forecast (SB), aggregation (Agg.), shorter gate closure and balancing products (Source: Algarvio & Knorr, 2017).

6.3 Operational practices: Market design

Experience of wind power participation in balancing markets from Spain, Texas and Colorado are listed in previous Sections 6.2 and 5.3.1. Market design issues for future generation capacity adequacy are discussed in 4.2. In this section the market design proposal, as well as barriers are listed from recent studies.

The Nordic system operators highlight that with higher balancing prices, volatility of day-ahead prices and tighter capacity margin foreseen for year 2025, today's market will not be able to secure adequate inertia, frequency and balancing reserves. Already geographically unbalanced volumes of automatic (FCR) and manually activated (FRRm) frequency control bids are seen. Power and reserve markets need to be developed to reflect power system needs, for example with increased time resolution from the current hourly dispatches. Transmission capacity should be utilised more efficiently for all the markets, developing capacity allocation options (Statnett, FG, Energinet, SvK, 2016).

In Germany the problems occurring due to high shares of variable renewables in the existing market design (energy only market) have been addressed by (Federal Ministry for Economic Affairs and Energy, 2015). An electricity market 2.0 instead

of a capacity market is preferred, with new market design supporting the integration of variable renewables with security of supply in the long term and an efficient dispatch. The proposed 20 specific measures are clustered in

- Stronger market mechanism
- Flexible and efficient electricity supply
- Additional security.

Examples for the measures are:

- Strengthening obligations to uphold balancing group commitments
- Opening up balancing markets for new providers
- Reducing the costs of grid expansion via peak shaving of renewable energy facilities

6.3.1 Market design features to enable wind power integration

The energy market design needs for higher shares of variable energy sources with low marginal generation costs was the focus of EU project Market4RES. High level policy recommendations were developed to ensure an effective market integration of variable renewable energy sources (Figure 62). In addition to developing market rules to fit variable generation, also the subsidy schemes for variable generation need to be developed to reflect the market operation.

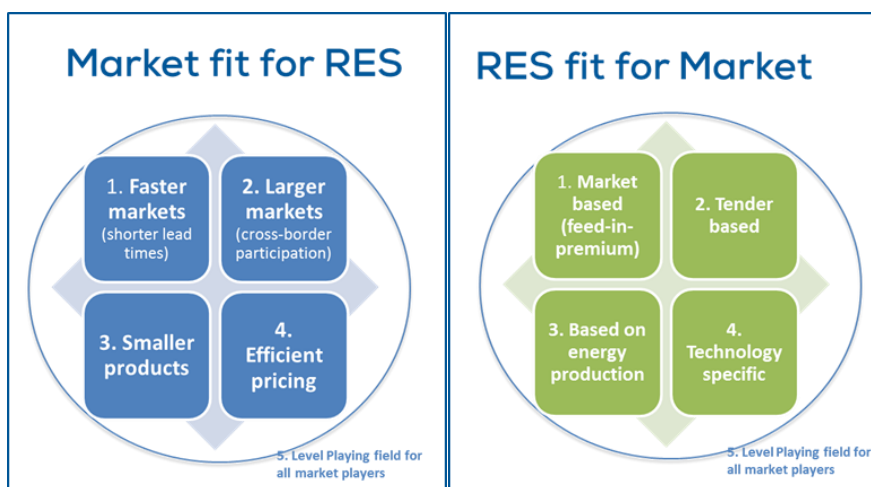

Figure 62. A set of recommendations aiming for the energy markets fit for RES at the same time ensuring that RES are fit for the market (Source: Market4RES).

Given the significant readiness costs that it would imply to upgrade wind power plants with minimum capabilities to provide ancillary services, the industry is promoting a general principle that services be provided voluntarily and be

adequately remunerated, via market based mechanisms, instead from mandatory requirements. A number of product design specifications and procurement rules need to be adapted to allow the provision of balancing services in a competitive and non-discriminatory fashion from new market players (renewable energy producers, storage providers, demand side response). WindEurope has developed a list of 10 top market design recommendations to enable more competitive and effective balancing markets (Figure 63).

The ten commandments on balancing markets: Key design features

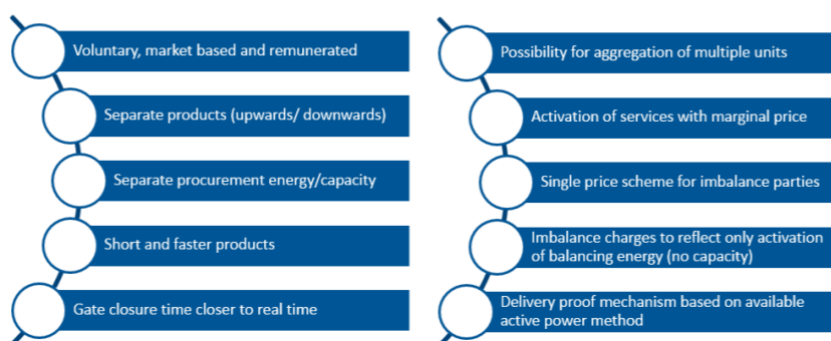

Figure 63. A list of 10 top market design recommendations to enable more competitive and effective balancing markets (Source: WindEurope, 2016).

6.3.2 New market products for high share wind systems

In Ireland, a market-based approach has been introduced to incentivise the efficient delivery of all system services, while incorporating product scalars to ensure adequate supply of individual services at times of system need. The technical definitions for replacement reserve and steady-state reactive power products have been refined and additional services have been introduced since 2016:

- fast frequency response (FFR) has been introduced to provide a power response in the timeframe 2–10 s, with limits placed on the recovery response, if appropriate.
- dynamic reactive response (DRR) rewards the ability to deliver reactive current for large voltage dips within 40 ms of event occurrence, providing reactive power equivalent to at least 31% of machine rating at nominal voltage. Such capability is only incentivised at very high ($\geq 70\%$) SNSP levels, and is intended to ensure that system transient stability is maintained,

despite the mean electrical distance between synchronous units increasing as more units are displaced by renewables.

- the ramping margin (1, 3, 8 hour) services aim to improve the longer-term operational flexibility of the system, mainly associated with wind variability and forecasting uncertainty, through quantifying the ability of units to increase/decrease their output with the defined notice period.
- The synchronous inertial response (SIR) service motivates generating units to reduce their minimum stable generator output at which voltage control can still be achieved, such that more units (and hence rotational inertia) can be 'squeezed' on-line during low demand periods.
- fast post-fault active power recovery (FPFAPR) service incentivises a unit to recover its active power output following a fault faster than the grid code requirement, i.e. 250 ms instead of 500 ms. The underlying concern, particularly at very high SNSP levels, i.e. beyond 70%, is a slow active power recovery following a fault disturbance, leading to a short-term system-wide imbalance between demand and generation, so called voltage dip induced frequency dips

In order to encourage existing market participants to provide the required system flexibility a range of product scalars is incorporated: locational (not currently active, but regional weightings could later apply), performance (forecasting of service availability, reliability of service provision, etc.), temporal scarcity (promote service availability during times of strong system need, i.e. high SNSP periods), continuous response (supply of all services across fast frequency to tertiary timeframes), faster response (responding before default activation delay), enhanced delivery (dynamic preferred over multi-stage static responses).

Three new market products were proposed from EU project Irpwind (Algarvio & Knorr, 2017):

- The renewable energy reserve product: a 15 minutes product similar to tertiary reserve (manually activated Frequency Restoration Reserve mFRR). It enables wind power plants to offer their forecast deviations (in energy) at balancing reserve markets and inform the system operator of the error magnitude.
- The short-term balancing capacity product: a 15 minutes product that complements the capacity based reserve mechanism and the intraday trading. Remuneration is first for the assigned capacity (marginal pricing), and further for the required energy (mFRR). Positive and negative reserve in separate products.
- The renewable power band: a 5 minutes product similar to secondary reserve (automatically activated Frequency Restoration Reserve aFRR). It enables wind power plants to use their frequency control capacity at balancing markets by offering a power band that can help the system operator resolve demand-supply unbalances.

6.4 Operational Practices: grid

Managing wind power in the grid operation is getting more attention. System operators need to handle congestions and keep the power flows in limits for stable system operation.

6.4.1 Using forecasts for grid operation

In France, methods for security margins dimensioning, have been derived from “long term” data and hypothesis (see long term Section 4.1.2). For week ahead, weather forecasts are available in both deterministic and stochastic forms. Renewable generation and demand based on ensemble weather forecasts represent scenarios (50 available up to 15 days) that are combined with scheduled and forced outages hypothesis on conventional productions. For these hundreds of scenarios of stochastic simulations regarding system balance and exchanges are performed (taking into account dynamic constraints), and according to levels of risks, statistical analysis are performed (Figure 64). Information that can be used from such calculations are available margins (upward and downward), “forecasts” on international exchanges and efficient identification of network solutions with coordination between countries.

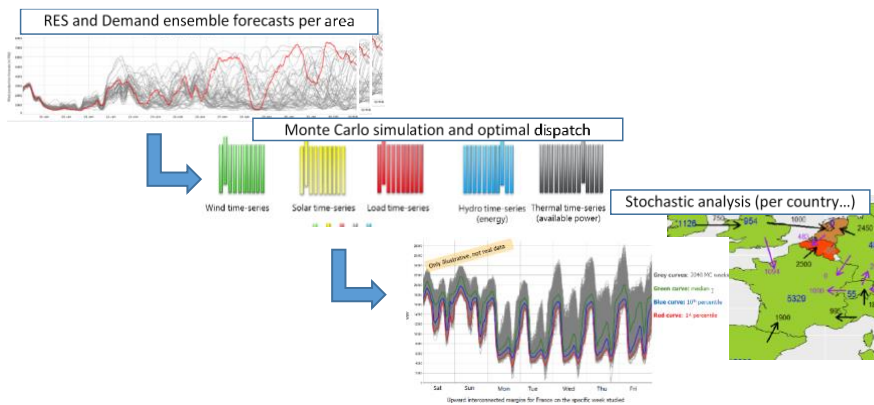

Figure 64. Weekly Margins analysis - process illustration (Source: RTE, France).

In Germany forecasting methods have been adapted to provide network operators with input data and information on uncertainty for real-time and anticipatory grid security calculations. Potentially available measurement data and weather forecasting and “nowcasting” models optimized for the power industry by the German Weather Service (DWD) were used by Fraunhofer IWES building models that estimated maximum possible values, actual values, and expected values of wind and solar PV generation over the next hours and days at nodes of the German electric grid. Transmission and distribution system operators applied the system in

grid management, also considering explicit measures for reducing power generation that are not weather-dependent.

6.4.2 Dynamic line rating

The main limiting factor for the transmission capacity of overhead lines (OHLs) is usually defined by a thermal constraint. The static line rating methodology, traditionally used by the system operators to ensure that the grid does not operate over the maximum pre-defined conductor temperature, determines the line's ampacity using seasonal weather conditions. These conditions usually underestimate the real transmission capacity of OHLs. Dynamic Line Rating (DLR) analysis models can represent a safe and cost-efficient way to deal with potentially congested electrical networks allowing the optimal integration of distributed renewable generation and contributing to increasing the power system's flexibility. According to previous studies, increment up to 20% the lines' ampacity values are expected by using a DLR approach when compared with the traditional static approach. Wind speed is described by several authors as the parameter having the greatest impact in the conductor thermal balance, followed by wind direction and ambient temperature, while the effect of solar radiation is much reduced when compared with the previous parameters (Duque et al., 2018). Since the primary resource that feeds the wind parks – wind – also blows over the local power lines, besides the energy production it also increases the lines' ampacity. Consequently, the wind cooling effect provides additional power line capacity when it is most needed, leading to a win-win situation (Duque et al., 2018). Thus, operational DLR analysis tools may be (and are already) used in some specific cases (Fernandez et al., 2016) to cope with high levels of wind power penetration in the power grid, avoiding potential line congestion.

In Italy, a tool which combines the CIGRE thermal model of conductors and a complex multi-span mechanical model of the line was developed by system operator Terna in collaboration with the University of Pisa, operating a direct measure on the conductor (see Table 9 and Figure 65). This is based on a new dynamic thermo-mechanical model for multi-span overhead lines that takes into account:

- the actual weather conditions (wind, sun, ambient temperature), hence the real conductor temperature, at each single span of the power line; the impact of weather uncertainty on the DTR of a transmission line is assessed using a Monte Carlo technique whose probability distribution functions are carefully tuned on the actual weather forecasting errors made in the proximity of the line;
- the mechanical interaction between adjacent spans due to different loads and temperatures; a complex multi-span mechanical model of the line takes into account the mechanical interaction between spans, due to the possible rotation of strings of insulators, as well as that the temperature of conductors can vary span by span, for different weather conditions.

Several case studies relevant to existing 400-kV and 150 kV Italian overhead lines show that steady-state rating is extremely precautionary: dynamic ampacity is from one third to two thirds higher than what was suggested by steady-state calculations, depending on season (the higher increase is in summer) and on voltage level (the higher increase is in the transmission link).

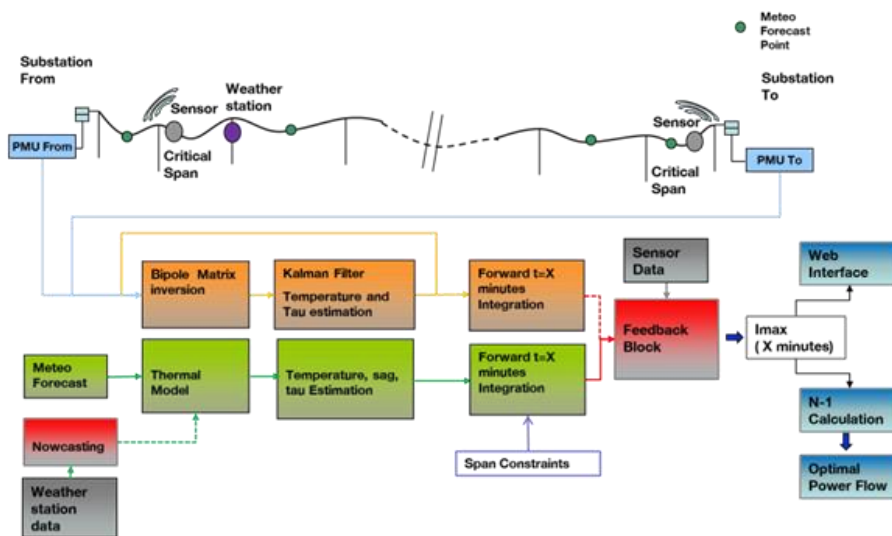

Figure 65. System architecture of Dynamic Line Rating adopted by Terna (Source: Terna).

Table 9. Overview of the current Dynamic Line Rating applications foreseen by system operator Terna.

Types applications	Features
N-1 congestion application for 380/220 kV lines	<ul style="list-style-type: none"> - Imax calculation for next 30' coherent with timing for dispatching orders to production units on Ancillary Service Market - Dynamic Imax used only for N-1 constraints, no change in N steady state limit - Imax values displayed on HMI for operators in Control Room - Imax values interfaced with EMS system (N-1, OPF)
N application for managing local congestion due to high RES production	<ul style="list-style-type: none"> - Imax calculation for next 30' coherent with curtailments commands to RES production units - Dynamic limits used for avoid/reduce RES curtailments - In case of wind clusters application high margins are guaranteed by the wind cooling effect
Transfer capacity increase between critical grid sections	
Nowcasting system under development in collaboration with meteo research institutes and universities for further accuracy improvements (50% error expected)	

Italy also pilots electrical battery storage for congestion management as described in Section 5.3.1

In Portugal, an operational DLR tool from research institute LNEG is presented in Figure 66 (Duque et al., 2018). To operationally use the DLR analysis, an external tool referred as Optimized Power-flow Model (OPF) (Castanho, 2017) was used to determine the power flow in the grid under analysis.

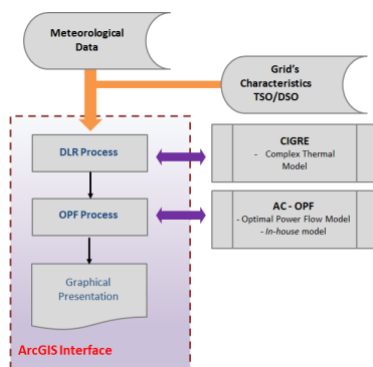

Figure 66. Schematic representation of the DLR analysis tool developed at LNEG (Source: LNEG).

The line capacity analysis for two hours (7.00 p.m. and 8 p.m.) is depicted in Figure 67.

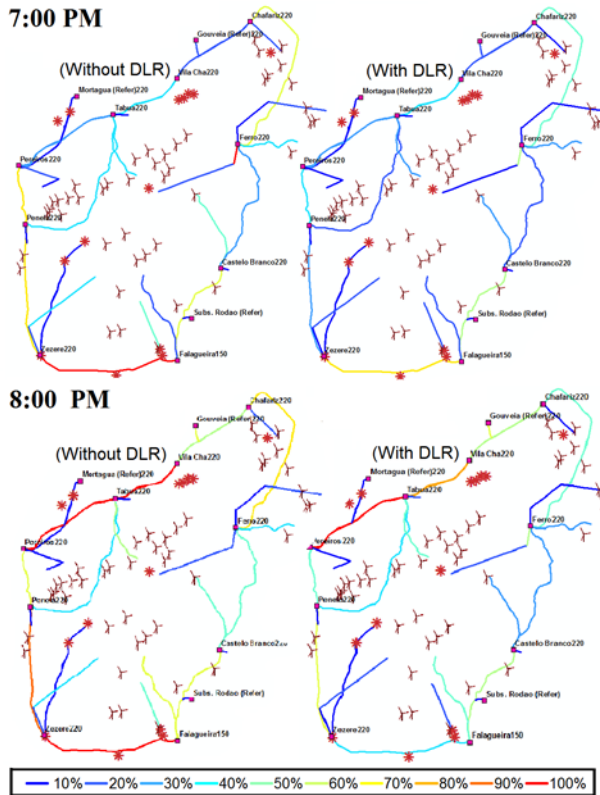

Figure 67. Representation of the lines capacity factor without and with the application of the DLR analysis tool – adapted from (Duque et al., 2018).

The DLR analysis reveals great increase on the line capacity limit values (Figure 67). With the exception of line 2173, DLR analysis tool shows that during the most critical hour (8:00 p.m.), the line close to saturation could still safely transport at least more 55% of power generation. The wind speed in this section (6.3 m/s) allied with an unfavourable wind attack angle of 12° in this particular section is still higher than the TSO current model consideration – 0.6 m/s. The results also show that there is a 96% overall improvement of the grid capacity for this case study, mitigating the risk of line saturation just to one line at 8:00 p.m., Figure 67.

In Ireland, a pilot project was launched in 2016 to install modular power flow control devices to investigate increased wind power while avoiding transmission line upgrades. The SmartWires SmartValve™ devices were installed on the Cashla to Ennis 220 kV line to demonstrate that SmartValve could operate as expected for one year on the live grid (Figure 68). Series compensation is used to increase or decrease reactance of a line, which causes power to be pushed away from or pulled onto the line. This effectively diverts current from overloaded lines, to underutilised

ones. EirGrid sees the potential of power flow technology to help meet the future needs of the grid.

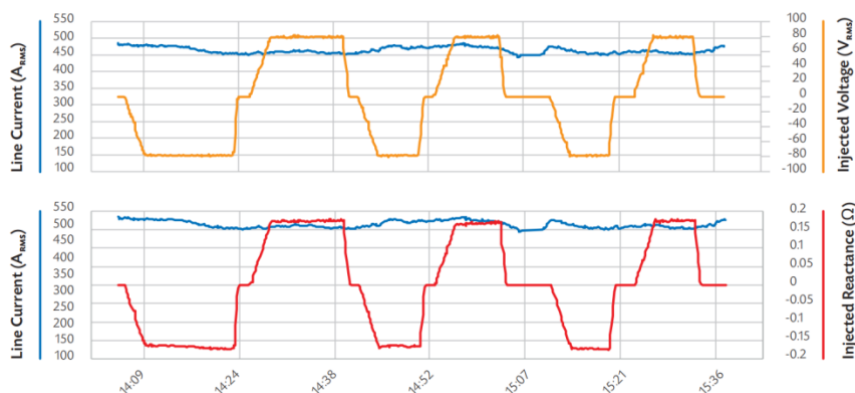

Figure 68. Plots from testing of the SmartWires SmartValve pilot installed on the Cashla-Ennis 220 kV line. The yellow traces shows the measured voltage injection from the devices which the red trace shows the impact on the line impedance. (Source: Smart Wires, EirGrid, 2016).

6.5 Flexibilities

Flexibility in power systems is the enabler to wind integration. In this section results from adding flexibility from storage, transmission, demand response and heat sectors are presented, as well as studies comparing the value of different flexibilities.

6.5.1 Co-locational storage at wind power plant

The possible functionalities of co-located wind energy and storage projects was made using examples from ongoing projects in WindEurope’s online database (WindEurope, 2017). Approximately 400 MW of co-located projects had been identified globally in the fall of 2017, with three quarters of them already operational (Figure 69).

The commercial viability of co-located projects is still very limited. Most of the existing installations are pilot projects or demonstrators. This is because the generation overcapacity in Europe creates a small spread between electricity prices, which does not provide for incentives to invest in energy storage for arbitrage. In addition, there are regulatory barriers that constrain the uptake of such projects. Some of these are high network charges, lack of a legal definition for storage assets, unclear grid connection compliance and performance requirements and the lack of commercially viable ancillary service products. Furthermore, there

are knowledge gaps in understanding the technical capabilities and limitations of co-located projects.

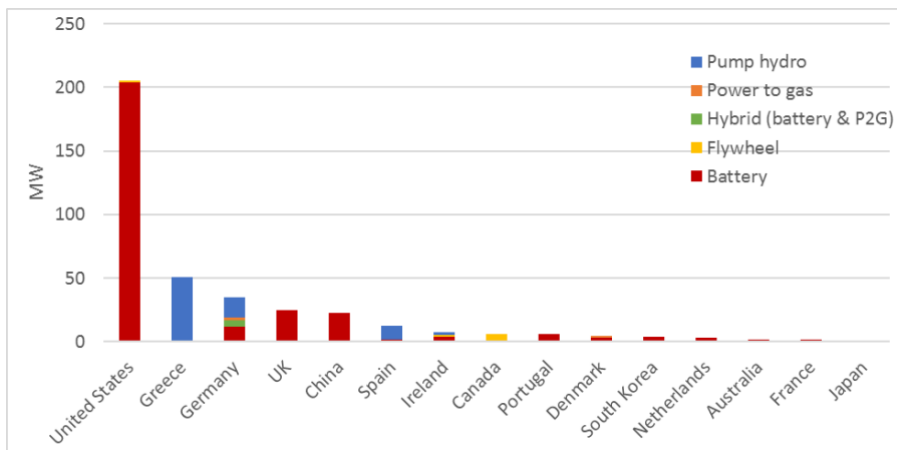

Figure 69. Co-located wind +storage project by country. (Source: WindEurope).

Co-locating wind energy and storage technologies could offer many benefits: It could reduce the amount of curtailed electricity at times of grid congestion or system instability. It could help maintaining generation schedules communicated to system operators, thereby reducing imbalance charges and avoiding penalties for not fulfilling the performance committed to the system. It could enable wind power to provide a wider range of ancillary services, such as frequency containment reserve (FCR), improve reactive power provision and even black start capability. In small power systems with stability issues, storage can support wind farms to reduce ramp rates, smoothing out electricity generation. Services of electricity storage and the potential value for co-locating storage with wind power plants are summarised in Table 10.

Table 10. Services of electricity storage and its potential value for co-location with wind power plant (Source: WindEurope).

Category of service	Services of electricity storage	Typical User	Size	Potential Value of Co-location	Type of Market
Energy Time Shift	Energy arbitrage	Generators	Large	Low	DA, ID
	Self-consumption	Generators/ consumers	Small	Low	DA, ID
Ancillary services	Frequency reserves	Generators Independent storage operators	Small	High	FCR, aFRR, Fast frequency response, synthetic inertia
	Voltage control	Generators TSO, DSO	Small	High	Reactive power
	Black-start	Generators Independent storage operators	Large	Medium	Ancillary services
Grid adequacy	Network Upgrade deferral	TSO, DSO	Large	Medium	TSO/DSO investment
	Congestion management	TSO, DSO	Large	Low	Redispatching mechanism
	Curtailment Reduction/ congestion	Generator	small	High	Balancing/redispatch mechanism
	Ramping control/ smoothing	Generator	Small	High	New product?
	Capacity firming/ Imbalance reduction	Generator	small	High	Balancing, Frequency reserves
System adequacy	Generation adequacy	Generators Independent storage operators	Large	Medium	Capacity market
	Seasonal storage	Generators Independent storage operators	Large	Low	DA, ID, Capacity market, new product?

6.5.2 Flexibility from hydro power with storage

Reservoir hydro power and pumped hydro storage offer great balancing capabilities, but are naturally limited by geographical and topological conditions. The large hydro reservoirs in the Nordic area provides an interesting flexibility resource in a European context: using them as “green batteries” for variable wind and solar power. Several studies have been carried out based on power market simulations,

for studying the use of Norwegian hydro power as a balancing resource for Europe, using the potential capacity increase described above as basis.

The North Sea interconnection with more offshore wind would result in more variable hydro power production (Figure 70), mainly because it is used more for balancing offshore wind power in the North Sea. Norwegian power prices would see a slight increase in average, but considerably lower extreme prices, as observed in Figure 71. This is because the increased interconnection capacity makes the Nordic power system less exposed to energy shortage in so-called “dry years”. Reservoir levels would not change noticeably with more interconnectors (Figure 72). This shows that the main technical barrier for utilizing Norwegian hydro power as a “green battery” lies in the limited power capacity of the cables and generations, and not the reservoir storage capacity itself (Jaehnert et al., 2015).

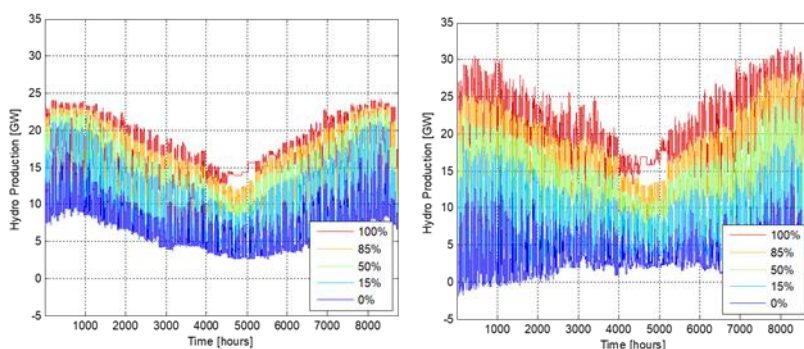

Figure 70. Simulated Norwegian hydro power production in 2010 (left) and 2030 (right), using the EMPS model with 75 climatic years for inflow, wind, temperature and irradiance (Jaehnert et al., 2015). The graph shows percentiles of production. E.g. 85% means that the production is lower than the corresponding value in 85% of the time.

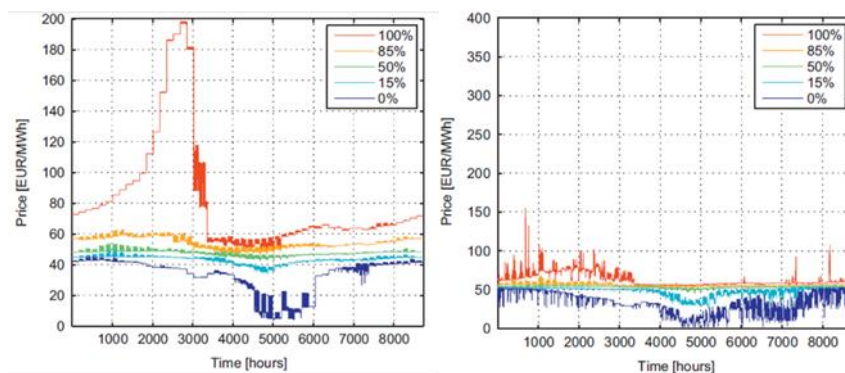

Figure 71. Simulated Norwegian power prices in 2010 (left) and 2030 (right), using the EMPS model with 75 climatic years for inflow, wind, temperature and irradiance

(Jaehnert et al., 2015). The graph shows percentiles of production. E.g. 85% means that the production is lower than the corresponding value in 85% of the time.

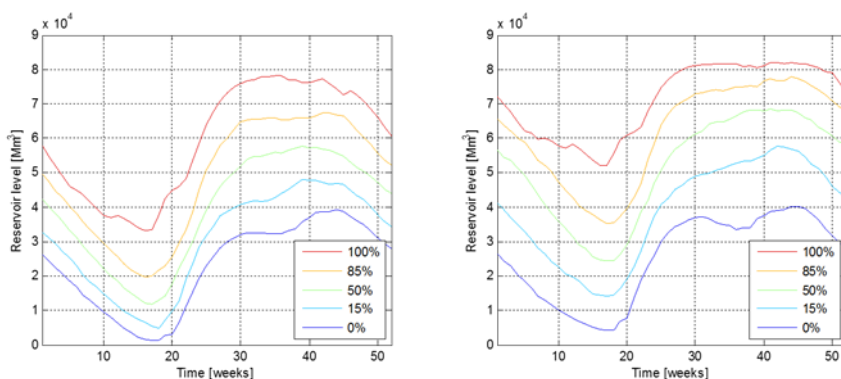

Figure 72. Simulated Norwegian reservoir level in 2010 (left) and 2030 (right), using the EMPS model with 75 climatic years for inflow, wind, temperature and irradiance. The graph shows percentiles of production. E.g. 85% means that the production is lower than the corresponding value in 85% of the time (Source: Jaehnert et al., 2015).

A model with higher hydro detail and better representation of short-term variations and flexibility show a clear impact on the hydro power pumping usage in scenarios with high shares of wind and solar. The new market model, FANSI⁴, is able to handle short-term wind and solar variations and pumping better than the well-established EMPS model (Figure 73). The scenario studied show impacts of adding pumped hydro and interconnections affect prices and use of hydro power for 2050 close to 100% RES scenarios (Graabak et al., 2017). With the FANSI model, the better usage of hydro capabilities is also causing less extreme prices due to load curtailments (Figure 74). The load curtailments is a consequence of a very tight power balance in parts of the simulated system, while the load was treated as a fixed input time-series with a very high curtailment cost. It was found that adding 5% price elasticity of demand had the same effect on price reductions as the simulated hydro capacity increase of 20 GW.

⁴ The previous name of the FANSI-model was "SOVN", which is used in the reference publications.

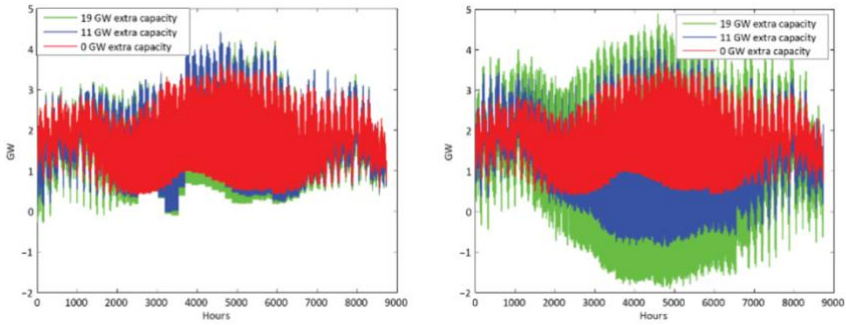

Figure 73. Aggregated production from selected Norwegian hydro plants for a near 100% RES scenario for Europe, using the EMPS model (left) and the FANSI model (right) (Source: Graabak 2018).

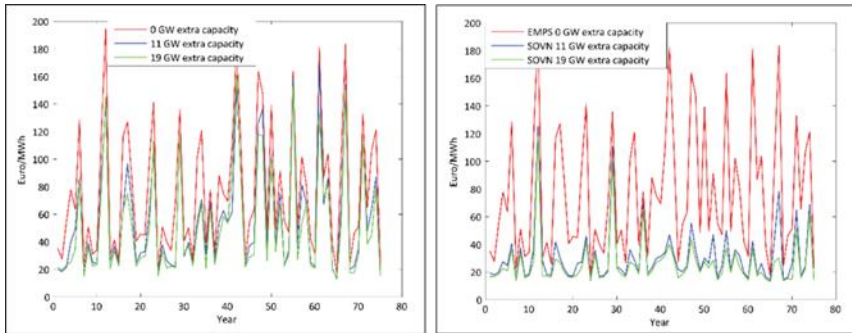

Figure 74. Simulated Dutch prices for a near 100% RES scenario for Europe, using the EMPS model (left) and the FANSI model (right) with different levels of Norwegian hydro power expansion (Source: Graabak, 2018).

In Canada, the Pan Canadian Wind Integration Study evaluated the benefit of changing hydro dispatch horizons. The base scenarios assume the scheduling of hydro according to a day-ahead net-load forecast, and that hydro dispatch *cannot* be changed during real time operations. Sensitivity analysis was undertaken to evaluate two alternative hydro dispatch options: 1) dispatch hydro against day-ahead load forecast only (e.g., ignore wind forecast entirely); and 2) dispatch hydro resources in a more flexible manner by adjusting their dispatch in real-time to compensate for errors in the day ahead wind forecast (i.e., real-time net load). Results of the analysis demonstrated that the benefit of re-dispatching hydro increased under higher penetration scenarios (Table 11). There will be a substantial incentive to use flexible hydro generation to compensate for the inherent errors in day-ahead wind energy forecasts for higher shares of wind power.

Table 11. Changes in Production Cost for Different Hydro Scheduling Practices (Source: Pan Canadian Wind Integration Study).

Scenario	Change in Adjusted Production Cost (C\$/M/year)	
	Hydro Scheduled Against Day-Ahead Load Only	Hydro Scheduled Against Real-Time Net Load
5% wind	100	-16
20% wind	494	-144

6.5.3 Flexibility from power and heat sector coupling

In China, potential flexibility for a region with high combined heat and power (CHP) proportion was estimated by a production simulation tool to analyze renewable accommodation under different measures in power supply. If the flexible adjustment ability of power supply side was able to be increased by 8 GW (6% total capacity), wind power curtailment rate would decrease from 17% to 4% (Figure 75).

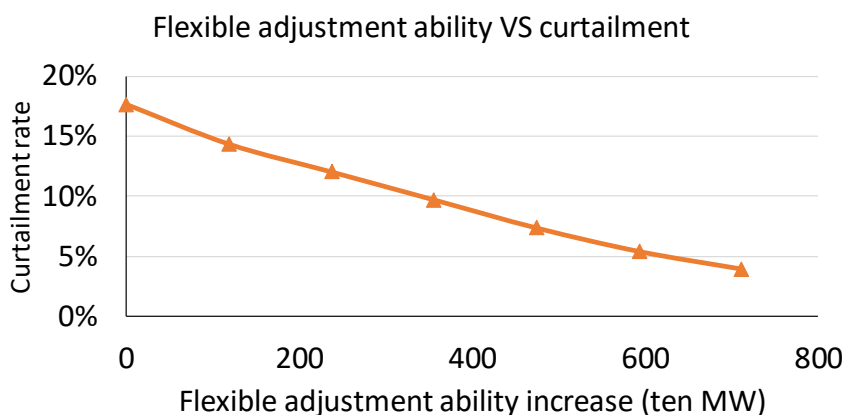

Figure 75. Influence of combined heat and power plant flexibility to wind power curtailments in China (Source: SGERI).

Helistö et al. (2018) considered the combined impacts of wind power and solar PV on the operation of thermal power generation based on optimized power plant and flexibility portfolios for the North European power and heat system. A generation planning model was soft-linked with a unit commitment and economic dispatch model for the Northern European system in 2050. In the scenario where the share of variable generation was approximately 40% of annual electricity consumption, large investments were made in combined cycle gas turbines. In the scenarios where the share of variable generation was approximately 60%, new gas power

plants were mostly gas turbines and gas engines. These essential results confirm the benefits of transitioning towards power plants with better flexibility, higher variable costs and lower fixed costs when the share of variable generation increases. A more unusual result was that introducing district heating related flexibilities in the system decreased the investments in combined cycle gas turbines and increased the investments in gas engines. The additional flexibility in district heating reduced the capacity factors of combined heat and power (CHP) plants, and consequently the cheaper gas engine CHP plants replaced the more expensive combined cycle gas turbine CHP plants although they would have been less costly to operate. District heating related flexibilities increased the share of wind power while electric vehicles increased the share of PV – district heating has longer time constants that are in line with the slower wind power fluctuations while electric vehicles have a daily cycle like PV (Helistö et al., 2018).

6.5.4 Flexibility through use of transmission and interconnectors to neighbouring area

In China, potential flexibility from grid was estimated by a production simulation tool to analyse renewable accommodation under different measures in power supply. If the transmission capacity could be increased by 12 GW, wind power curtailment rate will decrease from 17% to 4% (Figure 76).

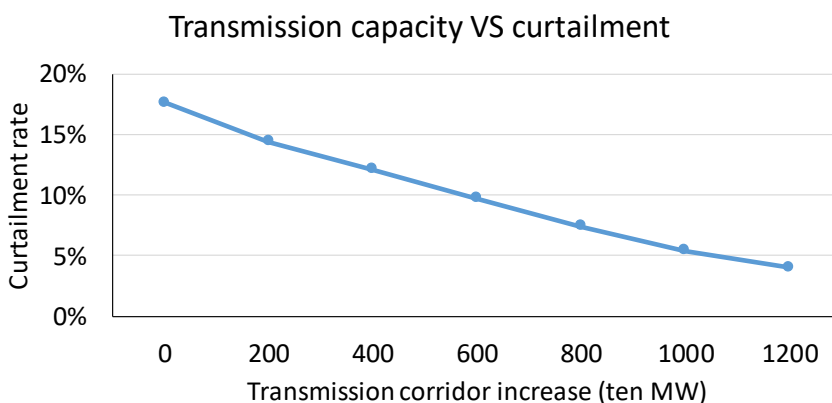

Figure 76. Influence of increased transmission grid flexibility to wind power curtailments in an example power system in China (Source: SGERI).

6.5.5 Flexibility from demand side measures

In China, potential flexibility from demand side was estimated by a production simulation tool to analyse renewable accommodation under different measures in power supply. In the demand side, if demand side response (valley load) could be

increased by 10 GW, wind power curtailment rate will decrease from 17% to 5% (Figure 77).

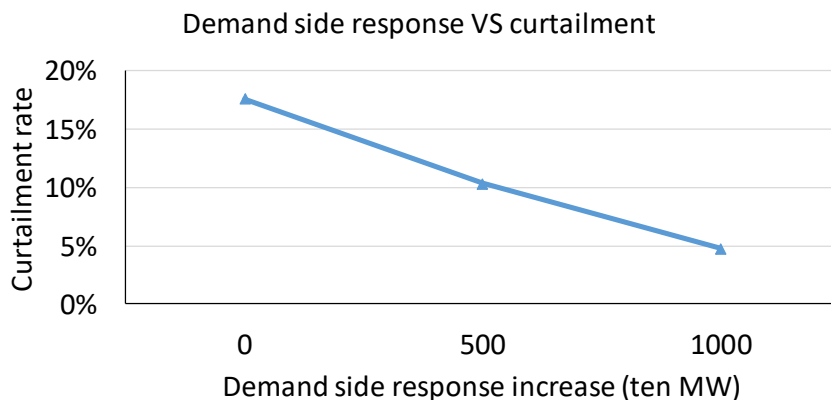

Figure 77. Influence of demand side flexibility to wind power curtailments in example power system in China (Source: SGERI).

6.5.6 Comparing flexibility options

In Finland, flexibility options in Northern European system covering countries around the Baltic sea was studied by comparing the system value of increasing flexibility in the system by several different sources Kiviluoma et al. (2017):

- demand response (Dem.resp.)
- increased flexibility of thermal generation (Flex)
- battery storages (Battery)
- pump hydro (PHP)
- transmission capacity: limiting the increase to 1.4 GW between regions(Trans), or letting the generation expansion model optimize without limits (Trans Unlm)
- heat sector flexibility: heat pumps, heat storages (Heat stor.), electric boilers (Elec.boiler), or all of these together (HP+HS+EB)

The study footprint consisted of Northern Europe (Nordic and Baltic countries, Germany and Poland) with lot of wind power (42–55% of energy). The results were presented as cost benefit: decrease of system operational costs for one year of simulation, minus costs to increase the flexibility. The heat sector and transmission lines have the greatest potential merits as a means to cost-effectively mitigate the variability of wind power. Increasing flexibility in generation side (thermal or hydro with pumping) gives close to zero cost benefit, so would be beneficial in some cases. Battery storage need to be really cheap (50–100 €/kWh) before it starts to decrease overall costs, although with a higher share of PV they may become beneficial sooner. As seen in Figure 78, sum of all flexibilities give less value than

summing each option separately. This shows that the individual flexibility options will compete with each other in system operation. The model detail (using scheduling model with linear programming or with mixed integer programming) gave more value for transmission and less for heat sector flexibilities (blue/grey bars in Figure 78) than using only generation expansion model (red bars).

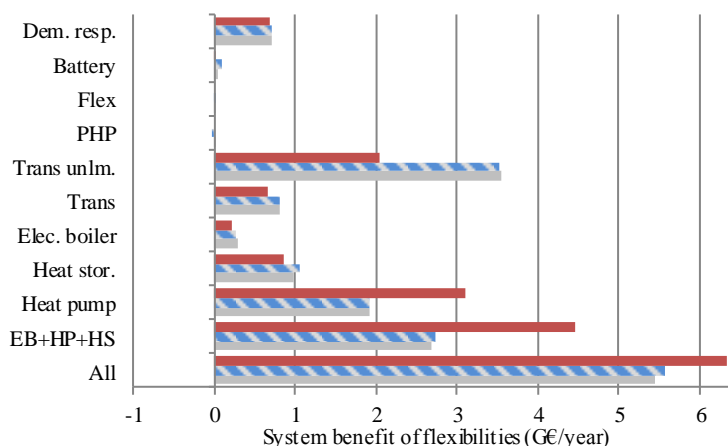

Figure 78. Comparing value of flexibility in the Northern European power system, when considering the operational cost reductions and the investment cost of the of flexibility (with no cost for demand response assumed; battery had a cost of 100 €/kWh). The bars represent detail of simulation model: red Balmorel; blue/grey Balmorel+WILMAR LP and grey Balmorel + WILMAR MIP.

In Norway flexibility options in North Europe covering countries around the North Sea were compared (Askeland, 2016):

- Pumped hydro from Norway + additional North Sea interconnectors (See Section 6.5.2)
- Open-cycle gas turbines (OCGT)
- Combined-cycle gas turbines (CCGT)
- Distributed Li-Ion batteries

A 2030 scenario based on ENTSO-E with ~ 40% renewable energy penetration in the Northern European power system (Nordic countries plus the countries surrounding the North Sea) was used. The (optimal) mix of flexible sources needed to balance the net load using an equilibrium modelling was estimated. Pumped hydro and batteries complements each other by taking different roles: Batteries provide short-term balancing over one to some hours, while pumped hydro counteracts the longer periods with prevailing low or high net load, as shown in Figure 79. This is because the cost of batteries are mainly driven by the kWh capacity, while the hydro storage costs are driven by the kW costs (cables + reversible pumps). Furthermore, it was shown that batteries reduces the need for

OCGT, while pumped hydro reduces the need for CCGT (Figure 80). However, for batteries to play an important role in balancing, its kWh costs must down to around 100 €/kWh according to the study (Askeland et al., 2016).

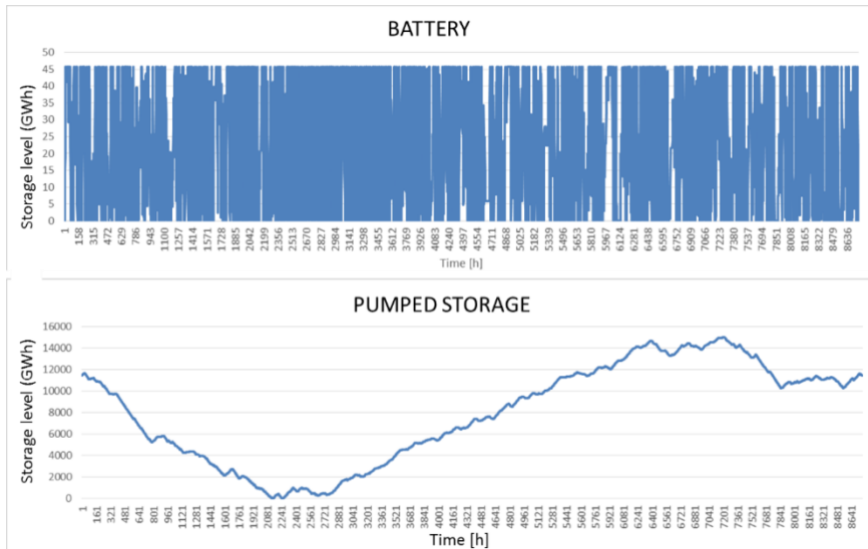

Figure 79. Utilization of ~10 GW of installed batteries and ~10 GW of pumped hydro for a North-European scenario with 40% RES (Source: Askeland et al., 2016).

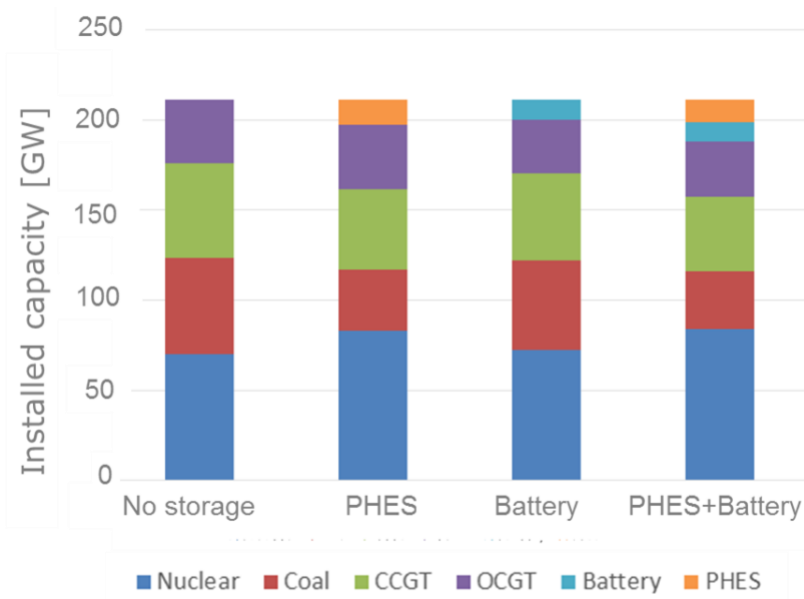

Figure 80. Optimal capacity mix of flexible units for a North-European scenario with 40% RES. The different bars represents different storage investment options (Source: Askeland et al., 2016).

6.5.7 Value of flexibility in reducing the system integration cost of wind power

In UK, the system integration cost has been revisited to compare variable renewables, especially offshore wind, to nuclear energy (Figure 81). Flexibility of future systems has a major impact on the results. The marginal system integration cost of offshore and onshore wind in 2030 (when compared against nuclear power) is found to be around £5–9/MWh across the medium to high flexible scenarios analysed in the study (Strbac & Aunedi, 2016).

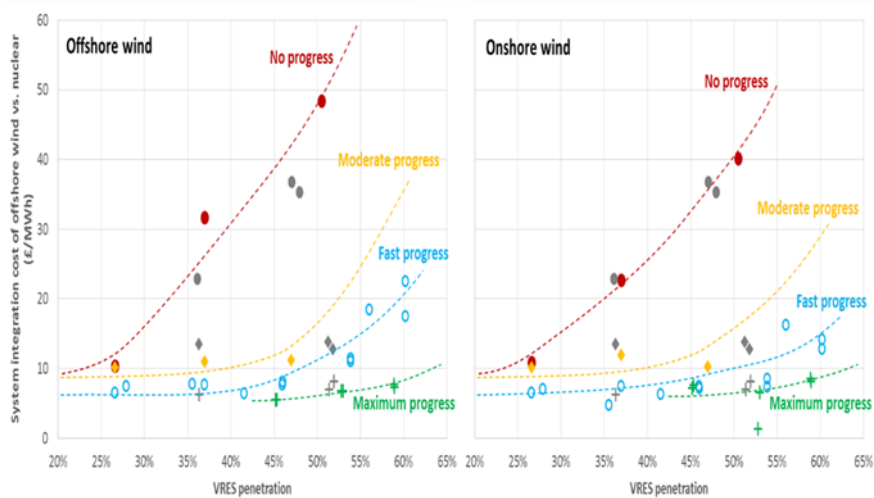

Figure 81. System integration cost estimated for a marginal increase of offshore and onshore wind for different penetration levels, as well as flexibility assumed in future system.

The majority of this cost (over 80% for flexible 2030 scenarios) is associated with the requirement to build sufficient firm (back-up) capacity when wind is added to the system, in order to maintain the same level of security of supply. Due to conservative assumptions regarding the cost of peaking capacity and the utilisation factor of nuclear generation this component represents an upper bound for the backup capacity cost of wind. A smaller part of integration cost of wind is associated with increased operating cost resulting from increased requirement for balancing services triggered by added wind capacity and it is possible that this results in some double counting as generators are, at least partially, exposed to these costs. Integration cost is presented as the incremental cost of replacing a marginal nuclear capacity with the equivalent wind power added on top the energy share of wind power in the system as shown in the x-axis. Therefore, the marginal system integration cost of wind tends to increase faster than previous studies show as a function of wind share. It is also important to note that the system integration cost of wind is system specific; we cannot compare the system integration cost of wind in the UK (an “isolated” island) with the integration cost of wind in Europe with a strong interconnection for example.

7. Pushing the limits: towards 100% shares of renewables

Summaries of recent wind integration studies, studying more than 40% share of wind in yearly electricity consumption are presented here. The results of seven integration studies with a wind power share of 30–40% of yearly energy show (Söder et al., 2017):

- Additional storage for system level demand-generation balancing has not been found necessary in any of the studies;
- Curtailments are in the range of single-digit percentages;
- The possibility to balance wind and solar in a larger area decreased the challenges;
- More transmission limits the challenges of curtailments.

In this section studies for close to 100% renewables are presented. The future power system operating at 100% non synchronous generation has not yet been seen, nor proved to work. This is an evolving research topic, where simulation model tools also need to develop to catch the resilience needed for system operators to trust non synchronous sources fully for stability support. However, the studies show the feasibility for the hourly energy balances, with varying amount of system services taken into account. The energy sector coupling with future power to X options electrifying heat, transport, industrial processes all offer potential solutions.

7.1 Operating the Danish power system without central power plants

The Danish TSO Energinet.dk is preparing for a power system based on 100% of renewable generation. The strategy is to build a high degree of necessary system support (voltage and frequency services etc.) into the grid and thereby avoid must run units for securing the system stability. With this target the following recent developments have been established:

- Refurbishment of two existing synchronous compensators (2010–12)
- 3 new synchronous compensators (2013–14).
- A new 700 MW HVDC VSC interconnector to Norway with advanced system support capabilities (voltage and frequency) (2014)
- Upgrade of 400 kV backbone transmission line in western Denmark

The developments are indicated in Figure 82, showing a layout of the present Danish transmission system.

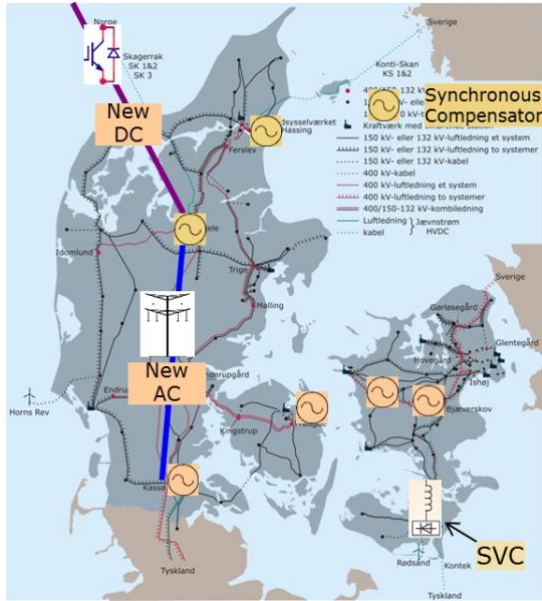

Figure 82. Layout of present Danish transmission system with recent developments to prepare for running the system without must-run units.

The 2nd September of 2015 (Wednesday) was remarkable in the sense, for the first time the system was operated without dispatching of primary central power stations. The system stability was ensured by the capability of the new DC VSC connection to Norway and the operation of 6 synchronous compensators (Figure 82). The reserves were procured from local plants (small scale CHPs) and from Norway (via DC VSC connection). The day was very windy with wind in some hours covering the whole Danish consumption. Likewise the weekend was very windy with a net export from Denmark. In contrast there was almost no wind on the Monday, where the load was covered by import and generation of primary plants and to some extent local plants. Figure 83 shows the resulting dispatch of the Danish system during the actual week in September 2015. As a weekly average, wind and PV covered 49% and 2%, respectively of the Danish load. Figure 83 illustrates the high flexibility over the week in generation and exchange with neighbouring countries (Norway, Sweden and Germany).

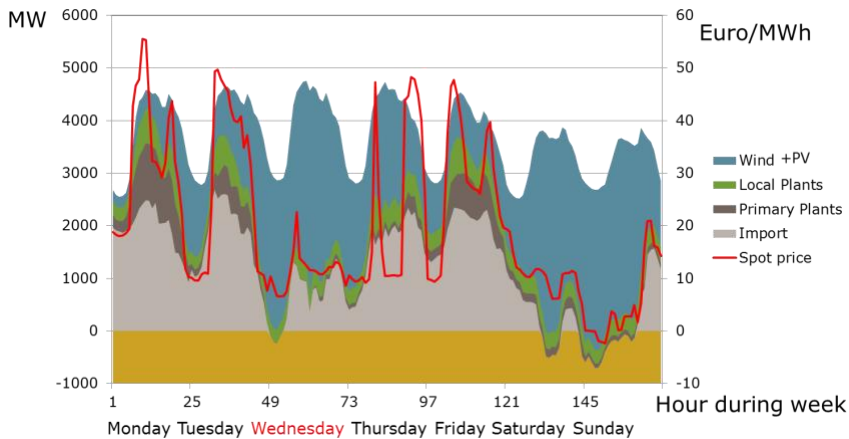

Figure 83. Week in September 2015 with high flexibility of generation and transmission.

Figure 83 also shows the spot price in the day-ahead market. As expected the price fluctuates over the week with high prices during low wind hours and low prices during high wind hours and even negative prices for some hours on the Sunday.

7.2 100% renewable electricity studies in Sweden

A study of 100% renewable electricity for Sweden has been performed. The country is considered isolated and the study estimates the need of new capacity when nuclear power is replaced with wind and solar power. The result is an additional need of around 5 GW of peak power from either import, demand side management, or new power plants. The needed energy is around 1% of total production and the cost is below 0.3 Eurocent/kWh (Söder, 2016).

The Swedish Energy Inspectorate has made a study where in one of the cases they assume that all nuclear power is dismantled to year 2030 and replaced with mainly wind power, resulting in close to 100% renewable production. This means around 16 GW of wind power and a wind-bio-solar production of 50 TWh/year corresponding to 35% of total production (Swedish Energy Markets Inspectorate, 2016). The results include:

- New wind power and reinvestment in wind power is profitable without subsidies ;
- It is essential that consumers can react on the power price;
- The price volatility will not increase significantly, mainly depending on increased transmission to neighbouring countries.

7.3 Global 100% renewable energy scenario and implications for Nordic countries

Global TIMES model results for a 100% renewable energy system show a strong electrification of the energy system – 400% increase in electricity demand globally. The global electricity system would be dominated by solar energy, except for North America, Europe and Russia where wind and solar would both provide more than 40% of electricity demand (Pursiheimo et al., 2018). The TIMES simulations do not capture the impacts of wind and solar to the power system, as the simulations include only selected time slices (day/night for different seasons). However, the energy sector coupling including heat, transport and industry energy use is captured.

The results for the TIMES model were fed to a more detailed models (Balmorel and WILMAR) for the Nordic countries to simulate a full year with hourly resolution, while considering electricity demand, synthetic gas demand for transport and industry and a fleet of electric vehicles (Ikäheimo & Kiviluoma, 2016). Long-term marginal cost of producing synthetic natural gas with power to gas (P2G) is shown in Figure 84.

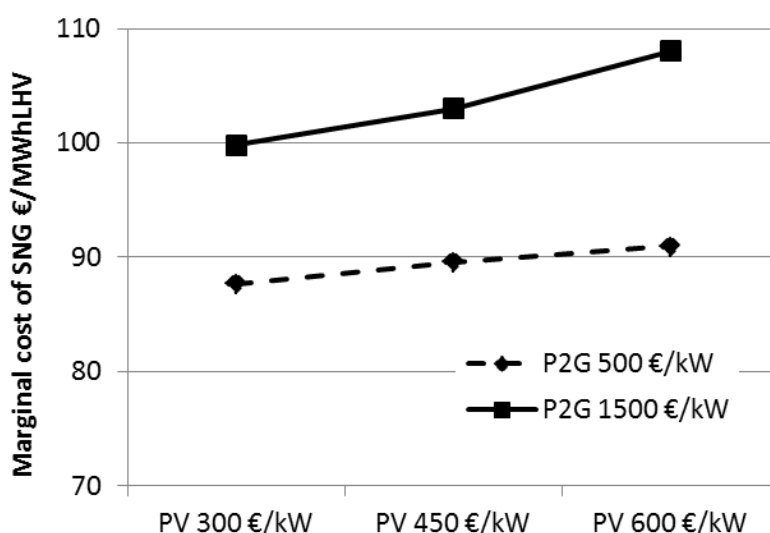

Figure 84. Long-term marginal cost of producing synthetic natural gas with power to gas (P2G). Even very low PV and P2G investment costs result in very high prices in comparison to current natural gas prices. (Ikäheimo & Kiviluoma 2016).

The hourly dispatch was further tested with frequency stability for the Nordic synchronous power system. The inertia levels were reduced to half of Nordic TSO study for 2025. 14% of time frequency nadir was below 49.2 Hz with 1400 MW incident and increasing the fast responding disturbance reserve (FCD-D) from 1300

to 1500 MW. With wind power providing fast response, there was risk of under frequency load shedding (<49Hz) only 0.1% time (Ikäheimo & Kiviluoma, 2017). The hydro dominated system helps in keeping the synchronous system stable even at 100% renewable energy.

7.4 European wide 60% renewable study

In France, the European power system was studied for a 60% renewable case (see Figure 85 for simulations models used in the study). Variable Renewable Energy Sources and conventional generation will play complementary roles in the European interconnected electricity system.

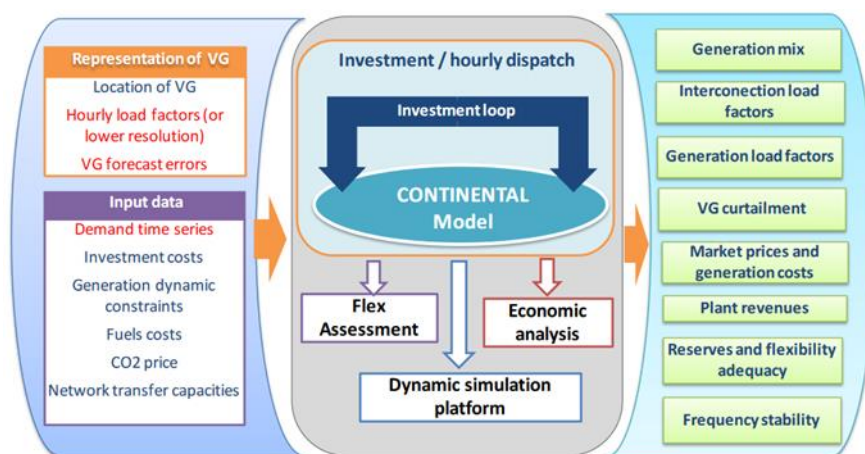

Figure 85. EDF and CONTINENTAL model for Electric system studies (Source: EDF, France).

While wind and PV production have key roles to play in the European strategy for the decarbonization of electricity production, hydro and thermal generation remain necessary in order to ensure system stability and security of supply. Generation of variable renewables will fluctuate tremendously across time (seasons, weeks, hours...) and space in the European grid (Figure 86).

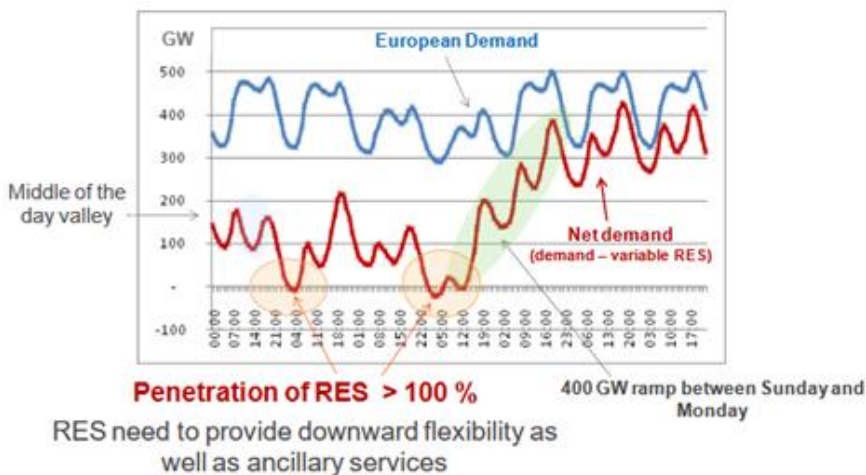

Figure 86. Generation balancing becomes quite complex for periods with high net demand variability (Source: EDF, France).

There could be large impacts on European system for balancing operations (balance production and consumption) or frequency behavior, requiring new mechanisms for providing flexibility, in order to manage variability from wind and solar productions:

- Network developments (both at transmission and distributions levels) are necessary to capitalize on the natural diversity in demand and the production from the different renewable sites.
- Demand response mechanisms should be developed to contribute to generation-demand balance.
- Storage development has to be considered to manage seasonal to hourly variations.
- New interfaces between grid and variable renewables (comparing to conventional production) will change drastically the network behavior and developing new controls and connection requirement is necessary.

The market value for renewables and storage will depend on the phase that they are deployed, that would benefit optimization (Figure 87).

The connection of wind farms and PV via power electronic interfaces will lead to a reduction in the inertia of the system. This reduction of inertia impacts the dynamic robustness of the system, namely the frequency following an incident. For low to moderate penetration of variable RES the synchronously interconnected European grid today has high inertia, which ensures that it has the capacity to accept a significant number of sources of production connected through power electronics interfaces. The frequency stability of European synchronous grid, with large amount of variables generation from renewable sources, was studied in (Wang et al., 2016).

With 40% variable RES, for the majority of cases, the overall European network appears to be sufficiently robust. That said, critical situations equivalent to a frequency nadir lower than 49 Hz that triggers under frequency load shedding and lower than the security level of 49.2 Hz could emerge. These are observed for periods with 25% instantaneous penetration of RES, when the overall system demand is low (<250 GW). A similar incident occurring during periods of high demand would not seem to pose a problem even for instantaneous penetration of RES as high as 70%, given that the load self-regulating effect will contribute naturally to the re-establishment of the system frequency. The most critical periods for frequency stability are those when demand is low. During these periods, it will be necessary to limit the instantaneous penetration of RES in order to maintain the security of the system. That said, innovative solutions such as the creation of synthetic inertia from wind farms or the contribution of wind generation to frequency regulation are expected to reduce the severity of some of these limits.

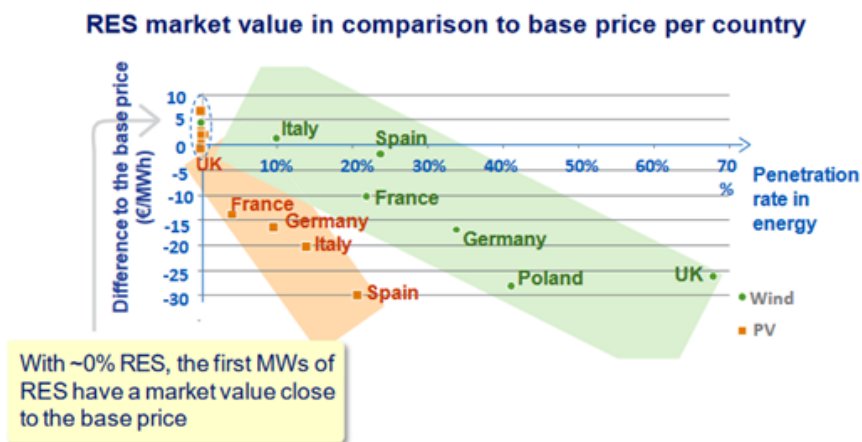

Figure 87. Market revenue gap of wind and PV (Source: EDF, France).

It's important to note that future studies are highly complex and need to investigate lot of fields and components. Analyses have to be updated as development for technology cost and efficiency for wind and solar power evolve.

8. Conclusions

This report summarises recent findings on wind integration from the 17 countries and Wind Europe participating in the International Energy Agency (IEA) Wind collaboration research Task 25 in 2015–17. The countries participating report increasing shares of wind on average (43% in Denmark, about 25% in Ireland, Portugal and Prince Edward Island (Canada), more than 30% the U.S. states of Iowa, South Dakota, Kansas, and Oklahoma). During certain hours more than 100% is generated in Denmark and Portugal; more than 80% in Italy and Germany and the small power system of Ireland allows a maximum non-synchronous 65% share (79% maximum share of demand experienced so far). The national case studies address several impacts of wind on power systems. This includes both long term planning issues as well as short term operational impacts, on which most of the work reported in this period has focused.

Recent experience in system operation from Texas highlights that fast response from wind power plants can help reduce the total fast frequency response needed in the system. In Quebec, wind power plants supported the power system recovering from a frequency event. Experience is building also from Colorado, California, Ireland, Spain, and Denmark showing that wind power can participate in frequency support services.

Denmark passed a landmark in their system; operating the system in high wind share situations without any large thermal power plants online. In this case the frequency and voltage control was provided by synchronous condensers, HVDC links and local smaller thermal power plants.

Integration studies are increasingly focused on taking into account possibilities for wind power plants to support the grid. Frequency stability was first studied in smaller systems such as Ireland, but it is increasingly being studied for larger areas that have higher shares of wind power (USA, Texas, Nordic countries, Mexico, Netherlands). Grid code capabilities for wind power plants are evolving and new capabilities like power oscillation damping are being studied (Denmark). The impact of forecast errors on balancing needs will reduce considerably for larger balancing areas, and shorter time scales (Finland). New ways to allocate operational reserves are reported from Texas, Germany and Japan.

System adequacy for future high share wind and solar systems highlights a need for multi-area assessment in adequacy estimates (Sweden, ENTSO-E). Recent studies point out the importance of many years of wind and load data to get robust results for wind power capacity value – 10 to 30 years in North Europe (Finland, France). System adequacy is also gaining interest in market settings. Studies in Finland and the USA show that in addition to low marginal cost wind and solar, over-capacity results in low energy prices. Ways to give correct signals from energy-only markets through scarcity pricing is being tested in Texas.

Transmission planning for larger areas with high shares of wind and solar remains a topical issue. A Europe-wide study (e-Highways) found the most beneficial transmission build out for future high renewable share power systems to

be mostly on the North-South corridors – an extra high voltage super grid layout was not found to be cost effective for Europe. Overplanting wind power capacity to transmission lines as a means to improve usage of grid investment showed benefits for offshore wind in the UK. The flexibility needs mitigated through transmission to reduce curtailments of wind power and to access flexibility from hydropower also been addressed in several studies

Enhancing the operation of the transmission grid includes dynamic line rating (Italy, Portugal), use of power flow control (Ireland) and forecasts (France, Germany).

Curtailments are seen as a sign of limits to wind integration in integration studies, and as a sign where the use of existing flexibility is not optimal (China, Japan). Germany struggles with increasing curtailments and re-dispatch operations due to delays in grid reinforcement. European countries still have limited amount of curtailments even if the share of wind is considerable. Ireland shows good improvement in developing its system constraints towards lower curtailments. The Pan Canadian integration study demonstrated that increased flexibility of hydro dispatch can reduce curtailment by using the increased flexibility as a form of operating reserves

Enhancing the use of hydropower storage to balance larger systems shows positive results also in Norway, pointing out also the need for more detailed simulation tools. Electricity storage is seeing initial applications by Italian system operator in reducing congestions for limited transmission capacity as well as providing frequency support.

Improving the market operations are highlighted from European studies and USA. Improving the value of wind energy in the markets are shown in Portugal, while Ireland has defined a suite of 14 system services, several of which can be supplied by wind generation, to improve system flexibility.

Decreasing curtailments through flexibility of transmission, demand side and power and heat coupling is shown in China. Comparing the value of different flexibility options in Northern European scenarios shows that electricity storage needs to go below 100 €/kWh in larger power systems as other means of flexibility. Electric battery storage and pumped hydro storage could take a short and long term storage role in future systems.

Regarding variability and uncertainty assessment, improvements in forecasting accuracy continue to be recorded (Spain, Germany). Analyses of extreme variability and forecast error events shows that they occur in storms. Analyses of weather situations and ramps help the extreme situations and ramp forecasting (Germany, Portugal). Wind and solar show good complementarity to reduce the aggregated output variability (Portugal). The weather model data is improving in its representativity for wind energy time series (Sweden) and tools for simulating large scale wind power generation are evolving (Denmark).

Integration studies for power systems that have close to 100% renewables are pushing the limits of how much variable generation can be integrated. Energy system coupling and use of power to X storages are seen in these studies. This work is ongoing, with more detailed modelling tools needed in future.

Acknowledgements

Natural Resources Canada (NRCan) would like to acknowledge contributors from NRCan, Canadian Wind Energy Association (CanWEA) and Wind Energy Institute of Canada (WEICan).

References

- Algarvio, H. & Knorr, K. 2017. New market products. Work Package 83 - Deliverable D83.2. IRPWind Project (<http://www.irpwind.eu>).
- Askeland, M. 2016. Analysis of the profitability of energy storage for RES in an equilibrium model of the power market. MSc Thesis. NTNU. <http://hdl.handle.net/11250/2405534>.
- Askeland, M., Jaehnert, S. & Korpås, M. 2016. Electricity Markets with Capacity Remuneration including Energy Storage. Presentation at the CEDREN Hydrobalance User Meeting. Available at: <http://www.cedren.no/Prosjekter/HydroBalance/Publikasjoner/HydroBalance-user-meeting-2016>.
- Asmine, M., Langlois, C.-E. & Aubut, N. 2016. Inertial response of wind power plants during a frequency disturbance on the Hydro Quebec system – Event analysis and validation. Proceedings of WIW16.
- Bernier, L. & Sennoun, A. 2010. Evaluating the Capacity Credit of wind generation in Quebec. 9th International workshop on Large-Scale Integration of Wind Power, Quebec, Canada.
- Bird, L., Lew, D., Milligan, M., Carlini, E.M., Estanqueiro, A., Flynn, D., Gomez-Lazaro, E., Holttinen, H., Menemenlis, N., Orths, A., Eriksen, P.B., Smith, J.C., Soder, L., Sorensen, P., Altiparmakis, A., Yasuda, Y., Miller, J. 2016. Wind and solar energy curtailment: A review of international experience. Renewable and Sustainable Energy Reviews, vol. 65, pp. 577-586
- Bloom, A., Townsend, A., Palchak, D., Novacheck, J., King, J., Barrows, C. & Gruchalla, K. 2016. Eastern Renewable Generation Integration Study. NREL/TP-6A20-64472. Golden, CO: National Renewable Energy Laboratory. Video available at: https://www.youtube.com/watch?v=jx9_4GNkblQ.
- Bundesnetzagentur, Bundeskartellamt. 2018. Monitoring report 2017 – key findings. Available at: https://www.bundesnetzagentur.de/SharedDocs/Downloads/EN/Areas/ElectricityGas/CollectionCompanySpecificData/Monitoring/KernaussagenENq_MB2017.pdf?__blob=publicationFile&v=2.
- Castanho, A. 2017. Análise de sensibilidade da capacidade de transporte da rede elétrica ao aumento da produção renovável distribuída: desenvolvimento de modelos de otimização. Master thesis. (In portuguese). Available at: <http://hdl.handle.net/10451/27622>.

- Couto, A., et al. 2016. The underlying role of the meteorology in wind power-Workshop. In: Apresentação oral – Workshop on Status and Outlook of IRPWIND WP8. Kassel (Germany), p. 43.
- Couto, A., Silva, J. & Estanqueiro, A. 2017. Following the demand by using strategic wind and solar complementarity – the case of Portugal. In 16th Int. Workshop on LS Integ. of Wind Power into Power Systems. Berlin, Germany, p. 6.
- Couto, A., et al. 2018. Probabilistic forecast algorithms for grid control D82.3. IRPWIND deliverable WP82.3 - V1, p.110.
- Cui, M., Zhang, J., Wu, H. & Hodge, B.M. 2017. Wind-Friendly Flexible Ramping Product Design in Multi-Timescale Power System Operations. IEEE Transactions on Sustainable Energy 8(3), pp. 1064–1075.
- Dobschinski, J. Siefert, M., Saint-Drenan, Y.-M., Braun, A., Vogt, S. & Röpnack, A. 2016. Development of innovative weather and power forecast models for the grid integration of weather dependent energy sources. Proceedings of the WindAc conference, Cape Town, South Africa, November, 2016.
- Duque, J., Santos, D., Couto, A. & Estanqueiro, A. 2018. Optimal management of power networks using a dynamic line rating approach. Renewable Energy & Power Quality Journal 1(16), pp. 584–589.
- EirGrid and SONI. 2018. Annual Renewable Energy Constraint and Curtailment Report 2017, published June 2018.
- ENTSO-E. 2017 Regional Investment Plan North Sea 2017. Available at: https://docstore.entsoe.eu/Documents/TYNDP_documents/TYNDP2018/rqip_NS_Full.pdf.
- ENTSO-E. Ten-Year-network Development Plan. Several editions available at: <http://tyndp.entsoe.eu/>.
- Federal Ministry for Economic Affairs and Energy, Germany. 2015. White Paper “An electricity market for Germany’s energy transition”. July 2015. Available at: <https://www.bmwi.de/Redaktion/EN/Publikationen/whitepaper-electricity-market.html>
- Fernandez, E., Albizu, I., Bediauneta, M.T., Mazon, A.J. & Leite, P.T. 2016. Review of dynamic line rating systems for wind power integration. Renewable and Sustainable Energy Reviews 53, pp. 80–92.
- Flynn, D., Rather, Z., Ardal, A., D’Arco, S., Hansen, A.D., Cutululis, N.A., Sorensen, P., Estanqueiro, A., Gómez, E., Menemenlis, N., Smith, C. & Wang, Y.

2017. Technical impacts of high penetration levels of wind power on power system stability. *Wiley Interdisciplinary Reviews: Energy and Environment*, vol. 6, no. 2.
- Graabak, I. 2018. Balancing of wind and solar power production in Northern Europe with Norwegian hydropower. PhD Thesis, NTNU, 2018:201.
- Graabak, I., Korpås, M., Jaehnert, S. & Belsnes, M. 2019, "Balancing future variable wind and solar power production in Central-West Europe with Norwegian hydropower", *Energy*, vol. 168, pp. 870-882.
- Hansen, A. & Altin, M. 2015. Impact of advanced wind power ancillary services on power system. DTU Wind Energy E-0081. Available at: http://orbit.dtu.dk/files/107186047/DTU_Wind_Energy_E_0081.pdf
- Hansen, A., Altin, M. & Cutululis, N.A. 2015. Modelling of wind power plant controller, wind speed time series, aggregation and sample results. DTU Wind Energy E-0064. Available at: http://orbit.dtu.dk/files/107186057/DTU_Wind_Energy_E_0080.pdf
- Hasche, B., Keane, A. & O'Malley, M. 2011. Capacity Value of Wind Power, Calculation, and Data Requirements: the Irish Power System Case. *IEEE Transactions on Power Systems*, vol. 26, no. 1, pp. 420-430
- Helistö, N., Kiviluoma, J. & Holttinen, H. 2017. Sensitivity of electricity prices in energy-only markets with large amounts of zero marginal cost generation. Proceedings. Article no. 7981893. 14th International Conference on the European Energy Market, EEM 2017, 6–9 June 2017, Dresden, Germany. doi:10.1109/EEM.2017.7981893.
- Helistö, N., Kiviluoma, J. & Holttinen, H. 2018. Long-term impact of variable generation and demand side flexibility on thermal power generation. *IET Renewable Power Generation* 12(6), pp. 718–726. doi:10.1049/iet-rpg.2017.0107. IET Digital Library, <http://digital-library.theiet.org/content/journals/10.1049/iet-rpg.2017.0107>.
- Holttinen, H. (Ed.). (2018). Recommended Practices for Wind/PV Integration Studies. RP16 Ed.2 issued by IEA TCP on Wind RD&D, August 2018. Available at: <https://community.ieawind.org/home>.
- Holttinen, H., Lemström, B., Meibom, P., Bindner, H., Orths, A., van Hulle, F., Ensslin, C., Hofmann, L., Winter, W., Tuohy, A., O'Malley, M., Smith, P., Pierik, J., Tande, J.O., Estanqueiro, A., Ricardo, J., Gomez, E., Söder, L., Strbac, G., Shakoor, A., Smith, J.C., Parsons, B., Milligan, M. & Wan, Y. 2007. Design and operation of power systems with large amounts of wind power. State-of-the-art report. Espoo, VTT. 119 p. + app. 25 p. VTT

Working Papers; 82 ISBN 978-951-38-6633-4. Available at:
<http://www.vtt.fi/inf/pdf/workingpapers/2007/W82.pdf>.

Holtinen, H., Meibom, P., Orths, A., van Hulle, F., Lange, B., O'Malley, M., Pierik, J., Ummels, B., Tande, J.O., Estanqueiro, A., Matos, M., Gomez, E., Söder, L., Strbac, G., Shakoor, A., Ricardo, J., Smith, J.C., Milligan, M. & Ela, E. 2009. Design and operation of power systems with large amounts of wind power. Final report, IEA WIND Task 25, Phase one 2006–2008. VTT Tiedotteita – Research Notes 2493, Espoo, VTT, 200 p. + app. 31 p. ISBN 978-951-38-7308-0 Available at:
<http://www.vtt.fi/inf/pdf/tiedotteet/2009/T2493.pdf>.

Holtinen, H., Kiviluoma, J., Robitaille, A., Cutululis, N.A., Orths, A., von Hulle, F., Pineda, I., Lange, B., O'Malley, M., Dillon, J., Carlini, E.M., Vergine, C., Kondoh, J., Gibescu, M., Tande, J.O., Estanqueiro, A., Gomez, E., Söder, L., Smith, J.C., Milligan, M. & Lew, D. 2012. Design and operation of power systems with large amounts of wind power. Final summary report, IEA WIND Task 25, Phase two 2009–2011. VTT Technology: 75, Espoo, VTT, 81 p. + app. 13 p. ISBN 978-951-38-7910-5. Available at:
<http://www.vtt.fi/inf/pdf/technology/2012/T75.pdf>,

Holtinen, H., Kiviluoma, J., Forcione, A., Milligan, M., Smith, C.J., Dillon, J., Dobschinski, J., van Roon, S., Cutululis, N., Orths, A., Eriksen, P.B., Carlini, E.M., Estanqueiro, A., Bessa, R., Söder, L., Farahmand, H., Torres, J.R., Jianhua, B., Kondoh, J., Pineda, I. & Strbac, G. 2016a. Design and operation of power systems with large amounts of wind power. Final summary report, IEA WIND Task 25, Phase three 2012–2014. VTT Technology: 268, Espoo, VTT, 115 p. + app. 10+ p. ISBN 978-951-38-8444-4. Available at: <http://www.vtt.fi/inf/pdf/technology/2016/T268.pdf>.

Holtinen, H., Kiviluoma, J., Milligan, M., Frew, B. & Söder, L. 2016b. Assessing capacity value of wind power. Proceedings. 15th Wind Integration Workshop, WIW2016 Workshop 15–17 November 2016, Vienna, Austria.

Ikäheimo, J. & Kiviluoma, J. 2016. Synthetic Natural Gas Production and Utilization in the North European Power System in 2050, 6th International Workshop on Integration of Solar Power into Power Systems, Vienna, November 2016.

Ikäheimo, J. & Kiviluoma, J. 2017. On Frequency Stability in the Future Renewable Nordic Power System with Gas Sector Integration. Solar Integration Workshop, October 24–25, 2017, Berlin. Available at: <http://bit.ly/2AJd1su>.

Jaehnert, S., Korpäs, M., Doorman, G.L. & Hyldbakk, I.M. 2015. On the profit variability of power plants in a system with large-scale renewable energy

- sources. In: 12th Int. conf. on the European Energy Market, EEM 2015. IEEE Press. ISBN 978-1-4673-6691-5.
- Jost, D., Braun, A. & Fritz, R. 2015. Dynamic dimensioning of frequency restoration reserve capacity based on quantile regression. 12th International Conference on the European Energy Market (EEM). doi:10.1109/EEM.2015.7216769
- Jost, D., Braun, A., Fritz, R. & Otterson, S. 2016. Dynamic sizing of automatic and manual frequency restoration reserves for different product lengths. 13th International Conference on the European Energy Market (EEM), pp. 1–5. ISSN 2165-4093.
- Kiviluoma, J., Holttinen, H., Weir, D., Scharff, R., Söder, L., Menemenlis, N., Cutululis, N.A., Danti Lopez, I., Lannoye, E., Estanqueiro, A., Gomez-Lazaro, E., Zhang, Q., Bai, J., Wan, Y-H. & Milligan, M. 2016. Variability in large-scale wind power generation. *Wind Energy* 19(9), pp. 1649–1665, doi:10.1002/we.1942.
- Kiviluoma, J., Rinne, E. & Helistö, N. 2017. Comparison of flexibility options to improve the value of variable power generation. *Int. J. Sustain. Energy*. doi:10.1080/14786451.2017.1357554.
- Koivisto, M. et al. 2018 Large-scale wind generation simulations: From the analysis of current installations to modelling the future. *J. Phys.: Conf. Ser.* 1102 012034
- Kuwahata, R. & Merk, P. 2017. German paradox demystified : why is need for balancing reserves reducing despite increasing VRE production? Proceedings of 16th Int'l Wind Integration Workshop, Berlin, Germany, 25-27 October, 2017.
- Lacerda, M., Couto, A., Estanqueiro, A. 2017. Wind Power Ramps Driven by Windstorms and Cyclones. *ENERGIES*, vol. 10, no. 10, pp. 1475.
- MAF. 2017. Mid-term Adequacy Forecast. ENTSO-E. Available at: <https://www.entsoe.eu/outlooks/midterm/>.
- Market4RES. 2016. Post-2020 framework for a liberalised electricity market with a large share of renewable energy sources. EU project final report, October 2016. Available at: <http://market4res.eu/wp-content/uploads/LR-Market4RES-final-publication.pdf>.
- Maurer, C. 2010. Gutachten zur Dimensionierung des Regelleistungsbedarfs unter dem NRV. Consentec, 12 December 2010, Aachen. Available at: <https://www.regelleistung.net/ext/download/dimensionierungBnetza>.

- Miettinen, J.J. & Holttinen, H. 2018. Impacts of wind power forecast errors on the real-time balancing need: a Nordic case study. IET Renewable Power Generation.
- MIGRATE (Massive Integration of Power Electronic Devices). WP1 Key performance indicators. Available at <https://www.h2020-migrate.eu/>.
- Miller, N.W., Shao, M., Pajic, S. & D'Aquila, R. 2014. Western Wind and Solar Integration Study Phase 3 – Frequency Response and Transient Stability. NREL/SR-5D00-62906, December 2014. Available at: <https://www.nrel.gov/docs/fy15osti/62906.pdf>.
- Miller N.W. 2015. Keeping It Together: Transient Stability in a World of Wind and Solar Generation. IEEE Power and Energy Magazine, vol. 13, no. 6, pp. 31-39.
- Milligan, M., Frew, B., Ibanez, E., Kiviluoma, J., Holttinen, H. & Söder, L. 2017. Capacity value assessments for wind power. Wiley Interdisciplinary Reviews: Energy and Environment 6(1). Wiley. doi:10.1002/wene.226.
- National Energy Administration in China. 2014. Wind Power Monitoring Report in 2014. [In Chinese].
- Ndreko, M. 2017. PhD dissertation: offshore wind power plants with VSC-HVDC transmission grid code compliance optimization and the effect on high voltage ac transmission system. 19th Dec 2017.
- NERC. 2017. 1,200 MW Fault Induced Solar Photovoltaic Resource Interruption Disturbance Report. June 20, 2017. North American Electric Reliability Corporation. Available at: http://www.nerc.com/pa/rrm/ea/1200_MW_Fault_Induced_Solar_Photovoltaic_Resource_/1200_MW_Fault_Induced_Solar_Photovoltaic_Resource_Interruption_Final.pdf.
- Nuño Martinez, E. 2017. Impact of renewable energy uncertainty on electric power system reliability. Ph.D. thesis. DTU Wind Energy. doi:10.11581/DTU:00000024.
- Nuño, E., Maule, P., Hahmann, A., Cutululis, N., Sørensen, P. & Karagali, I. 2018. Simulation of transcontinental wind and solar PV generation time series. Renewable Energy 118, pp. 425-436. doi:10.1016/j.renene.2017.11.039.
- Olauson, J. 2018. ERA5: The new champion of wind power modelling? Manuscript submitted to Renewable Energy (available at researchgate.net).

- Olauson, J., Bladh, J., Lönnberg, J. & Bergkvist, M. 2016. A New Approach to Obtain Synthetic Wind Power Forecasts for Integration Studies. *Energies*, article no 800.
- PCWIS. 2016. Pan Canadian Wind Integration Study. Available at: <https://canwea.ca/wind-integration-study/>
- PROMOTioN (PROgress on Meshed HVDC Offshore Transmission Networks) – the EU funded research project: <https://www.promotion-offshore.net/>
- Pursiheimo, E., Holttinen, H. & Koljonen, T. 2018. Inter-sectoral effects of high renewable energy share in global energy system, *Renewable Energy*, 2018, ISSN 0960-1481 <https://doi.org/10.1016/j.renene.2018.09.082>.
- Ramírez-González, M., Castellanos-Bustamante, R., Calderón-Guizar, J.G. & Malik, O.P. 2018. Assessment of inertial and primary frequency control from wind power plants in the Mexican Electric Power Grid. Submitted to *WIRES Energy and Environment Journal*.
- Rueda Torres, J.L., et al. 2018. Deliverable D1.2: Power System Analysis and Key Performance Indicators. Work Package 1 of MIGRATE H2020 Project. 31 Jan. 2018. Available at: https://www.h2020-migrate.eu/Resources/Persistent/cc3fa80b24ff5c91eab219441240322612a34978/MIGRATE_WP1_D1.2_final.pdf.
- Sakamuri, J.N., Altin, M., Hansen, A.D. & Cutululis, N.A. 2017. Coordinated frequency control from offshore wind power plants connected to multi terminal DC system considering wind speed variation. *I E T Renewable Power Generation* 11(8), pp. 1226–1236. doi:10.1049/iet-rpg.2016.0433.
- Sanchis, G., et al. 2015. Europe's future secure and sustainable electricity infrastructure – e-Highway2050 project results. e-Highway2050 Project Booklet, 2015 at <http://www.e-highway2050.eu/>.
- Söder, L. 2016. Simplified analysis of balancing challenges in sustainable and smart energy systems with 100% renewable power supply. *Wiley Interdisciplinary Reviews: Energy and Environment*, 5(4), July/August 2016, pp. 401–412. Available at: <http://onlinelibrary.wiley.com/doi/10.1002/wene.194/full>.
- Söder, L., Milligan, M., Orths, A., Pelling, C., Kiviluoma, J., Silva, V., Lopez-Botet Zulueta, M., Flynn, D. & O'Neill, B. 2017. Comparison of Integration Studies of 30-40 Percent Energy Share from Variable Renewable Sources. In: *Proceedings of 16th Wind Integration Workshop – Berlin*, October 2017. Available at: <https://community.ieawind.org/HigherLogic/System/DownloadDocumentF>

<file.ashx?DocumentFileKey=f0f06ab8-982b-bb47-5ff1-dae9a20fd408&forceDialog=0>

- Statnett, 2015. Energy-Only Market in Europe 2030. Oslo, Statnett.
- Statnett, Fingrid, Energinet, Svenska Kraftnät, 2016. Challenges and Opportunities for the Nordic power system.
- Statnett, Fingrid, Energinet, Svenska Kraftnät, 2017. Generation Adequacy – market measures to secure it and methodology for assessment.
- Statnett, FG, Energinet, SvK. 2018. The way forward. Solutions for a changing Nordic power system. March 2018
- Steiner, A., Koehler, C., Metzinger, I., Braun, A., Zirkelbach, M., Ernst, D., Tran, P. & Ritter, B. 2017. Critical weather situations for renewable energies e Part A: Cyclone detection for wind power. *Renewable Energy* 101, pp. 41–50. ISSN 0960-1481.
- Strbac, G. & Aunedi, M. 2016. Whole-system cost of variable renewables in future GB electricity system.
- Swedish Energy Markets Inspectorate. Ei R2016:14 Increased share of variable power production: Impact on prices and investment incentives for power producers. [In Swedish]. Available at: https://www.ei.se/Documents/Publikationer/rapporter_och_pm/Rapporter_%202016/Ei_R2016_14.pdf.
- Tanabe, R., Amano, H. & Yokoyama, A. 2017. An Analytical Method for Assessing Flexible Resource Adequacy of Power Systems with a High Share of Renewables. Proc. of 12th IEEE PES PowerTech conference, PT10, Manchester, United Kingdom, June, 2017.
- Terrier, V. 2017. North European Power Systems Reliability, M.Sc. Thesis. KTH, Sweden. Available at: <http://kth.diva-portal.org/smash/record.jsf?pid=diva2%3A1077673&dswid=-8334>.
- Vrana, T.K., Aas, E.S., Reigstad, T.I. & Mo, O. 2017. Impact of Present and Future HVDC Links on the Nordic Power Grid. ACDC conference, Birmingham, IET.
- Vrana, T.K., Flynn, D., Gomez-Lazaro, E., Kiviluoma, J., Marcel, D., Cutululis, N. & Smith, J.C. 2018. Wind Power within European Grid Codes: Evolution, Status and Outlook. *WIREs Energy and Environment*. Wiley. doi:10.1002/wene.285.

- Wang, Y., Silva, S. & Lopez-Botet-Zulueta, M. 2016. Impact of high penetration of variable renewable generation on frequency dynamics in the continental Europe interconnected system. IET Renewable Power Generation, 10(1), pp. 10–16.
- WindEurope. 2016. Ten Commandments of the wind industry on balancing markets. Position paper, available at <https://windeurope.org/wp-content/uploads/files/policy/position-papers/WindEurope-Ten-Commandments-of-the-Wind-Industry-on-Balancing-Markets.pdf>.
- WindEurope. 2017. Wind power project database. Available at: <https://windeurope.org/about-wind/database-for-wind-and-storage-colocated-projects/>.
- Wolter, C., Klinge Jacobsen, H., Rogdakis, G., Zeni, L. & Cutululis, N.A. 2016. Overplanting in offshore wind power plants in different regulatory regimes. In: 15th wind Integration workshop – International Workshop on Large-Scale Integration of Wind Power into Power Systems as well as on Transmission Networks for Offshore Wind Power Plants.
- Yasuda, Y., Bird, L., Carlini, E. M., Estanqueiro, A., Flynn, D., Forcione, A., Gómez Lázaro, E., Higgins, P., Holttinen, H., Lew, D., Martin-Martinez, S., McCam, J., Menemenlis, N. & Smith J.C. 2015. International Comparison of Wind and Solar Curtailment Ratio, 15th Wind Integration Workshop, WIW15-111.

Appendix A: Planned work for years 2018–20

In the international collaboration under IEA WIND Task 25, plans for years 2018-20 in national research projects in participating countries are summarised here.

China: State Grid Energy Research Institute (SGERI) will participate in the task work within the scope of proposed work plan. SGERI work will focus on grid expansion and flexible generation deployment for the better utilization of wind power. For the model development, multi-regional power system expansion planning model with high wind power penetration, short-time-scale probabilistic production simulation incorporated with wind power model and operation optimization in power system with high penetration of wind power will be studied.

- For the optimum deployment of energy resources in the nationwide, we will study the proper grid configuration and grid planning in China. Planning of new flexible generation and its coordination in capacity, distribution and operation with wind power and other kinds of renewable generations will be researched in depth.
- Developing probabilistic production simulation model that will mainly consider the uncertainty of wind power. This will include new algorithm for production simulation which can describe the variability of wind power better.
- Investigate and research on economic and technologic impact on hybrid AC and DC power system with the rapid growth of wind power in China.
- Operation optimization method developed for enhancing the operational flexibility in power system with large amount of wind power, and its objective is to promote more efficient utilization of installed wind power. This include more flexible control of interconnection lines, more larger balancing area control, adjustment of unit commitment, economic dispatching under consideration of large-scale wind power, coordination between thermal power, hydro power and wind power, etc.
- Research on the coordination between thermal power, hydro power and wind power in Northwest China, and build the models of upgraded dispatching pattern for better utilization of wind power.
- For the better utilization of wind power, some technologic and managing means have been proposed from sides of generation, grid and consumption, for examples, conjoint exploitation and operation of thermal power and wind power, demand side response etc., to the reasonable application of these means, we plan to investigate their capability for enhancing the integration of wind power and the corresponding economic and environmental benefits and costs.
- Updating the power generation expansion model with adding new power generation types such as energy storage, CSP and distributed generation

Denmark: Technical University of Denmark (DTU) and the TSO Energinet will participate in the Task work. DTU will contribute to the annex through sharing of the research done in the area of wind power integration and control in a number of ongoing proposed EU and national projects. Research results are foreseen to be in the areas:

- Offshore wind power grid integration
- Optimization of offshore wind power electrical infrastructure
- Weather dependencies in power systems with high shares of renewables
- Wind power plant control and ancillary services from wind power plants
- RES grid integration studies, combining market with dynamic models
- Tools for representing combined wind and solar variability and uncertainty

Energinet.dk will contribute to the Task through sharing the results of the TSO-task of preparing the Danish power system for 50% wind power penetration by 2020, which is a fixed political target (50% of domestic consumption delivered by wind). Today's penetration is 43% (2017).

In the planning assumptions for 2017, Energinet expects the wind development to continue and reach a penetration of 90% of classical consumption and 70% of total electricity consumption, respectively in 2030.

More specifically, the Energinet contributions are foreseen to be in the following areas:

- The challenges of operating a wind power dominated power system without conventional power stations on line (how to provide inertia, sufficient short circuit power, and continuous voltage control and dynamic voltage support during and after faults).
- Methods for planning of new transmission lines in power systems with a large wind power share
- Sector coupling, i.e. integrating heat sector, the transport sector and the gas sector into power system planning. The objective is to create additional flexibility, storage and balancing opportunities. Besides, new transmission lines abroad will increase the ability to accommodate more wind.
- Reporting from the Danish and Nordic initiatives on updating of market design for accommodating future increasing amounts of variable renewable generation
- Reporting from Nordic cooperation on challenges and solutions of the Nordic power system. Focus is on transition of the system into accommodating higher amounts of renewables and closing thermal and nuclear units
- Reporting from the ENTSO-E collaboration on European Transmission System development. Wind continues to be one of the important triggers for grid investment needs in ENTSO-E's TYNDP (Ten Years Network Development Plan).
- Reporting from the 'North Seas Wind Power Hub' project – i.e. investigations on the concept of an artificial island in the North Sea hosting various assets

to facilitate lower cost integration of offshore wind power, power-to-x assets and international markets

- Reporting from North Seas countries offshore collaboration – member state driven initiative to overcome barriers related to offshore projects (wind and infrastructure).
- Reporting from the ongoing European projects
 - PROMOTioN – “PROgress on Meshed HVDC Offshore Transmission Networks” <https://www.promotion-offshore.net/>
 - The project intends to eliminate the technical and regulatory barriers associated with a meshed offshore HVDC grid.

Finland: VTT Technical Research Centre has relevant work on-going in national research projects VaGE and EL TRAN; EU projects Spine and Sysflex and EU project VaBiSys:

- improving the optimisation of storage use and other longer time scale decisions utilizing up to 2-week calibrated stochastic energy forecasts from mesoscale models (VaGe)
- improving the energy system modelling – sector coupling and combination of planning and operational time scales (Spine)
- improving the flexibility from distribution network resources to transmission system frequency control (Sysflex)
- improving the flexibility from biomass for high wind/PV share systems (VaBiSys)

France: From France the participants are EDF R&D, RTE the Transmission System Operator of France, and MINES ParisTech.

EDF R&D, the research centre of Electricité de France (EDF), will contribute to the annex through sharing of the research done in the area of wind power integration and control in a number of ongoing research projects. The projects in the 2018 to 2020 time frame present significant research overlap with IEA Task 25 and contributions of EDF R&D include sharing experience about the following topics:

Methodologies and tools to support the operation of systems with variable generation:

- Development of probabilistic tools for quantifying the impact of wind and PV forecast errors on operation margins and reserve requirements and its application to the definition of dynamic reserve requirements;
- Development and application of probabilistic tools for the assessment of flexibility adequacy of power systems, for different time scales (from day-ahead to 30 min ahead).
- Dynamic stability of power systems with high penetration of non-synchronous generation
- Participation of wind generation to ancillary services and synthetic inertia in large interconnected systems;

Methodologies and tools to study the long term impacts of the integration of wind and PV on the European electricity system:

- Experiences with the development and implementation of methodologies to address operational issues in long terms planning tools for large interconnected systems: EDF R&D chain of tools includes dynamic stability and near term flexibility assessment in the long term generation planning across several interconnected systems.
- Methodologies for cost benefit analysis of flexibility sources such as storage, demand side management and interconnections;

Economics of electricity systems with large penetration of variable generation:

- Integration of variable generation (wind and PV generation) into electricity markets: market price depression and revenue cannibalisation effects;
- Challenges for conventional generation: investment in backup capacity, decrease of revenues in energy only markets and opportunities represented by growing ancillary services and reserves markets;
- Wind participation in markets : strategies for minimising imbalance costs for variable generation producers;

The research division of RTE, the French TSO, will contribute to the task force by sharing results and experience obtained in the field of RES integration to large power systems through its participation to several national as well as European projects. Over the 2018–2020 period, topics to be addressed are expected to focus on:

- Optimal mix of flexibility (sizing and operation), taking into account multi-scale issues (local vs global access to flexibility sources, real-time effects)
- Technical requirements for the operational stability of power systems with a very high share of distributed sources connected to the grid via power electronics devices.
- Innovative system services required in such contexts (e.g.: inertia, synchronisation), and the proposal of adequate market rules for an efficient procurement thereof
- Impact of climate change scenarios (2050 horizon) on the French mix regarding availability and feasible generation levels of power units (RES as well as conventional units, including hydro dams)

MINES ParisTech will participate with the research Centre PERSEE (processes, renewable energies and energy systems). PERSEE develops research on the integration of renewables in power systems and electricity markets and on smart grids. The research contributions of PERSEE will be in relation to ongoing and projected R&D activities in the frame of PhD theses as well as national and European projects. The proposed contributions include:

- Wind and PV power probabilistic forecasting as well as combined forecasting of wind and PV. Focus will be given on 1) improving short term predictability

through spatio-temporal methods 2) on methods appropriate for the case of ancillary services provision and 3) on developing approaches that maximize the value of forecasts as a function of the application.

- Advanced forecasting tools, alternative to the classical ones, for decision making. These include probabilistic ramps forecasting, prediction risk indices, warning tools etc.
- Stochastic optimisation methods for maximising the revenue of virtual power plants composed by wind, PV and physical hedging options (i.e. storage) through the exploitation of multiple options (participation in markets, ancillary services...)
- Optimal management of electricity grids taking into account uncertainties, smart grid technologies through the optimal power flow approach.
- Forecasting of dynamic line rating (DLR) and methods for its inclusion in the management of power systems.
- New architectures of power systems to accommodate large scale penetration of renewables by 2030/2050 and beyond.
- Simulation of the evolution of electricity prices and electrical demand for prospective studies of power systems.
- Maximisation of RES penetration through synergies of different energy vectors (electricity, gas, heat etc. networks).

Germany: Fraunhofer IEE will further contribute to the Task work with their results and experiences achieved from the participation in several national and European projects like EERA IRPWind, GridCast, NEW4.0, Prophecy and ModernWindAbs, with the following subjects:

- Wind and PV power forecasting
- Extreme forecast errors and warning methods
- Dynamic line rating
- Provision of ancillary services with wind energy and PV
- Characterization of wind and PV power production on different aggregation levels and interaction between wind energy and PV
- Available Active Power Estimation
- Uncertainty based load flow calculation/predictions
- TSO-DSO interactions
- Simulation of the electricity supply system with a high share of RES
- Renewable virtual power plants
- Definition of data requirements for a secure power system with high shares of RES

The Research Center for Energy Economics (FfE) will further contribute to the Task work with their results and experiences mainly achieved from the projects “Merit Order of Energy Storages by 2030”, the follow-up project “Merit Order of Network Development” and “eXtremOS” as well as C/sells with national public and industry funding. FfE will mainly contribute with the following subjects:

- Spatially resolved RES expansion and its impact on grid and storage requirements
- Provision of ancillary services from devices located in the distribution grid
- Demand for grid extension
- Storage demand
- Analysis of hindrances arising from market design
- Integration of prosumer in the energy system
- Effects of extreme developments on the value of flexibility from a regulatory and technological perspective

Ireland: Subject to formal agreement with Sustainable Energy Authority Ireland (SEAI), the Energy Institute at University College Dublin and Energy Reform Ltd. will participate in IEA Task 25.

Energy Reform Contribution

Energy Reform Ltd specialises in research and consultancy in the field of energy system modelling and renewable integration. Energy Reform has represented Ireland on IEA Wind Task 25 since 2014 and members of the team have been active participants since the Task's inception. Energy Reform Ltd. is actively involved in research and consultancy activities directly related to the integration of wind and solar power in Ireland and internationally. This includes participation in a number of relevant Horizon 2020 projects including SPINE (LCE-05-2017), FlexiTransStor (LCE-04-2017) and RealValue (LCE-08-2014). The team has an excellent network within the Irish renewable energy sector spanning industry and research institutions and particularly with Energy Institute at University College Dublin and the Sustainable Energy Research Group at University College Cork. Energy Reform proposes to make the following specific contributions:

- The team have been significant contributors to the first and second editions of the Recommended Practices for Wind and Solar Power Integration Studies. Energy Reform will continue to contribute here by ensuring the current state of the art is captured and developments in assessing the impacts and value of wind and solar PV are conveyed.
- Continued contributions to joint articles in the areas of Grid Code and wind power curtailment
- Provision of Irish research developments relevant to wind and solar power integration
- Evolution of the Irish ancillary system services market to support wind and PV integration and the international relevance of such developments
- Developments and Irish experience in methodologies for planning power systems with large amounts of wind power, in particular in the following areas:
 - Co-optimisation of long term investment planning and detailed operations
 - Planning of power systems under uncertainty

- Energy Systems integration impacts for wind and solar integration arising from Energy Reform's involvement in the International Institute for Energy System Integration and the SPINE H2020 project.
- Arising from participation in the RealValue H2020 project, provision of results from demand response demonstrations in Ireland and impacts on wind and solar power integration

Energy Institute Contribution

The Energy Institute concentrates its research on Energy Systems Integration (ESI) which provides the basis for enhanced energy performance, reduced cost and minimises environmental impact – a challenge across the world. The Energy Systems Integration approach considers the relationships across electricity, thermal, water and fuel systems and data and information networks to ensure optimal integration and inter-operability across the entire energy system spectrum. The Energy Institute is funded by industry partners, philanthropic donations, national (Science Foundation Ireland - Investigator, Catalyst, Research Fellowship, Industry Partnership, Research Infrastructure; Enterprise Ireland Commercialisation Fund; Irish Research Council; Government departments, etc.), international (EU H2020, EU Marie Curie, etc.) and additional other industry awards. The various ongoing project initiatives have significant research overlap with IEA Task 25, including:

- Development of operational & planning tools and strategies for the integration of high levels of wind energy
- Stability of power systems with high shares of non-synchronous generation
- Feasibility of 100% power electronics-based (wind & solar) power systems
- Demand-side and storage options for enhancing power system flexibility, and integration within future electricity markets
- Design of market mechanisms and system services suitable for systems with high flexibility requirements
- Development strategies for forecasting and utilising system services from wind generation
- Interaction between electrical, gas, heat and water networks for complementary system support services

The research activities involve significant interaction with other IEA Task 25 partners (e.g. Energinet.dk, DTU, VTT, EDF R&D, TERNA, SINTEF, Imperial College), leading to joint journal publications and staff exchanges. In addition, national collaborators (e.g. Economic and Social Research Institute, Dublin City University, University College Galway, Trinity College Dublin), and a wide range of industry (e.g. EirGrid, Electricity Supply Board, Glen Dimplex, Electric Power Research Institute, Ervia) are partners and collaborators across various national and international projects.

Italy: Terna Group is the majority owner of the Italian electricity National Transmission Grid (e.g. 99% of all, ~72,900 km of electric lines), dealing with grid's

operation, maintenance and development of high voltage and very high voltage grid over the whole of Italy. Terna is the first independent electricity transmission grid operator in Europe and the sixth in the world based on the size of its electrical grid.

The Italian power system is going to be operated with a very high share of asynchronous generation (e.g. PV and wind power plants connected through a converter): basically, all long-term scenarios assume a substantial growth of renewables over 2030 (up-to 100 GW), with a massive uptake of solar (up-to 60 GW). Namely the National Energy Strategy 2017 set out entails ~28% RES share of final energy consumption (and 55% of electricity consumption). This causes on the one hand decreasing reserve margin during peak time, reduced rotational inertia to cope with frequency dynamics and stability, lower short circuit power levels to meet suitable quality of the supply, reactive power for voltage regulation, and, in general, shrinking stability margins against large perturbations, the effect of which could spread over areas of hundreds of kilometres; on the other, it raises an increasing need of flexibility, n. of congested hours and over-generation spillage mainly affecting the Southern areas. Terna has developed procedures aimed at identifying critical operating conditions in terms of balancing between generation and load and suggesting measures to maintain such balancing. These measures are pertinent to the operational stage (e.g. reduction of the power import from Northern border, optimal exploitation of existing pumping storage plants, dynamic security assessment in real time, special protection schemes, Wide Area monitoring systems WAMS, wind/ solar/ demand predictive algorithms, dynamic thermal rating, load shedding of interruptible customers), the planning stage (e.g. location and sizing of new pumping storage plants or batteries, installation of synchronous condensers, grid development or High Temperature Low Sag HTLS reconductoring for solving local overloads), and the market of ancillary services (e.g. ongoing pilots on demand response, aggregated DG, and relevant generating units integrated with storage system to provide FCR). As such, Terna will give contribution to Task 25 on the following topics:

- Redesign of Italian ancillary services market to enable participation of demand, distributed generation and storage
- Results from Terna's experimentations on grid-scale battery projects
- Straightening pumped-storage hydroelectric capacity available for load balancing and to capture excess electricity from inflexible renewables
- Dynamic Security Assessment and Real-time Decision Support Systems
- Design of defence plan for responding to high share of variable renewable energy, with special focus on the retrofit of the application of frequency settings for new dispersed generation units and the retrofit of dispersed generation that have inadequate frequency disconnection settings
- Resource Adequacy methodology (DSR modelling, probabilistic assessment of the residual load ramps/ need for flexibility, load-temperature dependency, etc.)

Japan: Tokyo University of Science and Kyoto University and CRIEPI will participate in the Task 25 from Japan. They will bring to Task 25 collaboration work on following topics:

- Capacity value of wind and photovoltaic power generation including the impact of the difference of the peak demand period (the difference of the area) will be evaluated.
- Kyoto University and other collaborating organization will study on economic analysis regarding grid investment under large VRE share in Japan using TIMES model
- A national renewable integration study will have as topics:
 - The characteristics of load with large amount of renewable integration
 - Regulating and operating reserves to accommodate renewable integration
 - Analytical approaches and simulations including;
 - long-term power supply planning,
 - pumped storage hydro power operational planning,
 - unit commitment and load dispatching control,
 - simulation of sub-hourly operations,
 - real-time frequency controls, etc.
 - The impacts to grid operations if renewable energy goals over 2030 are achieved or exceeded
 - Recommendations for possible facilitation/mitigation measures to large amount of renewable integration.

Mexico: INEEL (Instituto Nacional de Electricidad y Energías Limpias) is planning to participate in the task work. There will be work on the following issues:

- Assessment the adverse impact of large-scale integration of Wind and PV generation in the Mexican Interconnected Power System , considering the penetration levels of generation established in Mexico Laws. We will develop the next topics:
- Application of methodologies to define the highest levels of integration of renewable sources
- To develop a methodology for defining optimal location and capacity of energy storage systems to increase the penetration of variable renewable power plants
- Frequency regulation analysis
- Dynamic analysis (Transient, Voltage and Small-signal stability studies)
- Evaluation of mitigation actions to overcome adverse effects
- Evaluation of the required transmission network reinforcement.

Norway: NTNU and SINTEF will participate in the Task work. The contribution will focus on the following topics relevant to the integration of offshore and onshore wind power in Northern Europe:

- Utilization of Nordic hydro flexibility to balance wind and solar power variations in Europe
- Investment strategies of offshore grids with high offshore wind penetration
- Socio-economic benefits and costs of offshore grids and its impacts on power system control and market operation
- Utilization of distributed flexible
- resources (battery storage, electric vehicles, demand response) to facilitate more wind and solar power in distribution grids
- Production of hydrogen from large-scale wind power in remote areas

Studies will be coordinated and built on recent and on-going European and national research projects, including IRPWind (2014–2018), NOWITECH (2009–2017), CEDREN (2009–2017) NSON, Market4res, ProOfGrids, Hyper (2016–), Norwegian Energy Road Map 2050 (2016–). Moreover, NTNU and SINTEF is responsible for two new and relevant centres for Environmental friendly Research (CEERs) funded by the Norwegian Research Council. These are HydroCen (Norwegian Research Centre for Hydropower Technology) and CINELDI (Centre for intelligent electricity distribution).

Portugal: LNEG will coordinate the participation in the Task work. INESC TEC will continue to contribute to the work with the new participation of R&D NESTER, the Portuguese TSO R&D company (tbc). The Portuguese participation in national and European projects in 2018–2020 is centred on the following topics:

- Virtual Renewable Power Plants (VRPP)
 - Optimal aggregation of renewable distributed resources, assessment of the excess of renewable energy generation and need for added energy storage capacity both on large/national and small/local bases (e.g. pumped hydro, PV systems, batteries and plug-in vehicles). Development of VRPP unit commitment and market models for application in power system stability studies, participation on the electricity markets, and local network congestion for the characterization of the VRPP technical and economic benefits.
 - How to address the role of Prosumers in a context of a larger concept of VRPP?
 - (LNEG) Development of decision-support tools based on stochastic optimization for VRPP managers in order to boost their market integration). Analyse the role of Prosumers using modelling tools. LNEG is currently involved in the new Horizon 2020 project PV-Prosumers for Grid where the integration of PV Prosumers in the grid is addressed.
 - (INESC TEC) Development of a data-driven control function for distributed energy resources associated to a VRPP, including storage units.

- Storage Systems and Electric Vehicles
 - (LNEG) Assessment of the impact of EVs, domestic DGs and smart battery energy storage solutions in the local grid power quality. Characterization of local power quality.
 - (INESC TEC) Integration of storage and EV connected to the low voltage grid in a voltage control function located at the secondary substation (MV/LV) level.
 - INESC TEC – SMARES project (FCT/ ERA-net Smartgrids – 2016-2018) – Development of a multilevel modular converter for the enhancement of grid-code compliance and system support services including primary frequency control capability through the adoption of storage. The converter is to be developed by a project industry partner, GP-TECH. INESC TEC contributed by developing the converter dynamic model comprising the manufacturer specifications and performed dynamic simulations in order to assess the performance of the converter in a real Portuguese Distribution Grid. The next steps are to test a reduced-order converter prototype over a Power Hardware in the Loop (PHIL) testbed at INESC TEC laboratory. The aim is to demonstrate the converter operation to the WF promoter and the DSO. Finally, INESC TEC will follow the real size converter deployment on the WF and will help on the SAT.
 - The role of DER in power systems dynamic performance – within the REStable project (Eranet smart Grids plus), it will be address the identification of dynamic equivalents of active distribution networks with a fleet of heterogeneous DER (e.g., wind, solar generators, CHP, mini-hydro, storage, etc.) being the main goal the identification of a procedure that replaces the actual distribution network model by a simple equivalent model which has similar dynamic characteristics. Furthermore, the procedure to be identified will be validated in reduced-scale laboratory set-up using a power hardware-in-the-loop platform.
- Transmission Tools for Large Wind Integration
 - (LNEG) Development of dynamic operational tools for grid congestion management based on regional wind power (and other VRE) clusters. (FCT OptiGrid and P2020 SMARTRating).
 - (INESC TEC) Security of supply (reliability) analysis of bulk power systems, considering uncertainty from renewable energy and electricity market dispatch (MORA project under development for REN).
 - INESC TEC – H2020 EU-SYSFLEX, 2017–2021 – This project aims at developing tools to assure the European Power System stability on scenarios up to 50% of renewable energy. INESC TEC will contribute on the development of a set of tools consisting on building up equivalent dynamic models of distribution grids with renewables, to be further used on dynamic simulations of transmission systems. Also, flexibility

evaluation tools are to be developed enabling system operators to quantify the existing flexibilities existing on a given moment.

- Advanced wind power forecasting algorithms.
 - (LNEG) Develop a circulation weather pattern modelling system to search for atmospheric conditions that increase numerical weather forecast uncertainty (IRP Wind)
 - (LNEG) Automatic detection of wind ramps and extreme wind events with drastic impacts on the power system by the characterization of synoptic weather regimes and their transitions. (FCT Fluctwind – characteristics of ramps and fluctuations).
 - (LNEG) Deterministic net load tool forecast tool capable to consider the renewable energy generation and consumption at the different regional scales and time horizons (LNEG project OptiRES).
 - (INESC TEC) Development of a renewable energy forecasting system for smart grids that combines machine learning and feature engineering techniques. An operational deployment of forecasting system is expected in a real-world scenario.
 - Operating Reserves
 - (LNEG) Development of a methodology for rational use of dynamic reserves based on the forecast of extreme wind events.
 - (LNEG) Access the contribution of coordinated wind power clusters and storage assets in providing balancing services (FP7 IRP Wind).
- Markets
 - (LNEG) To address the challenges of using software autonomous agents to help manage the complexity of electricity markets, particularly:
 - Pool markets and the associated technical and economic issues, notably issues related to auction mechanisms (Project EU IRP Wind).
 - Forward markets and the associated bilateral trading process, mainly the negotiation of the key terms of bilateral contracts (price, amount of energy, duration, etc.) (FCT project MAN-REM)
 - Analyse the new topic of peer to peer electricity market.
 - New market products to allow the contribution of wind power generation in grid support services (LNEG project OptiRES)
 - (LNEG) To model power generating companies as software agents able to trade energy in different markets, notably pool and forward markets, placing emphasis on their decision-making process, typically affected by several uncertainties (e.g. power plant outages, uncertain market prices for electricity, imperfect wind power forecasts, etc.) (Project IRP Wind)
 - (LNEG) To model wind power plants clusters as coalitions of software agents, able to participate in liberalized electricity markets. To develop specific case studies (Project EU IRP Wind).

- Wind power deployment – planning tools
 - (LNEG) Planning tools for ~100% renewable power systems, to support future renewable deployment scenarios considering the wind resource complementarity and key factors as the electricity demand, interconnections, and the grid constraints.

Spain: UCLM-IER (Universidad de Castilla-La Mancha/Instituto de Investigación de Energías Renovables) will participate in the Task work. There will be work on reviewing and collecting information about the Spanish existing studies. On-going topics:

- Analysis of the relationship between power fluctuations from non-manageable generation sources and forecast errors, paying special attention to pattern recognition.
- Characterization of the wind power share in the ancillary services in power systems.
- Assessment of two main possibilities for future wind power plants: repowering and/or extending the useful life of wind turbines.
- Development and validation of generic models for non-dispatchable renewable energy sources.
- Real-time simulation of the models and control systems previously developed for wind farms and solar PV power plants participating in ancillary services.
- Wind profile characterization and development of a calculation methodology.
- Analysis of renewable energy integration impact on the grid. Stationary and dynamic grid studies for assessing the power system stability under different integration scenarios.
- Variable generation plant modelling. Studies of power systems with large amount of variable energy wind power: storage and electric vehicles

Sweden: The participating institute is the Royal Institute of Technology, Kungliga Tekniska Högskolan, KTH, in Stockholm. The on-going and planned national projects are related to:

- Methods for estimation of risk of capacity deficit in multi-area power systems with high amount of wind power (PhD student Egill Thomasson)
- The role of flexible consumers i future renewable power system (PhD student Lars Herre)
- Voltage Control on the transmission grid using wind power at other voltage levels (PhD student Stefan Stankovic)
- Flexibility for Variable Renewable Energy Integration. Nordic Energy Research (post doc Shahab Nazari)
- Use of CHP as a balancing resource is systems with large amounts of wind power (PhD student Ilias Dimoulkas)

- Efficient Optimization Methods for Hydro Power Operations in systems with high share of variable renewable energy sources. (PhD student under recruitment)
- Minimizing curtailments in power systems with high share of wind and solar power (PhD student: Elis Nycander)
- SNOOPI: Smart Network Control with Coordinated PV Infeed (Lennart Söder + post-doc Poria Hasanpor)
- General studies of application of new storage techniques in power systems with large amount of wind power (new PhD student: Dina Khastieva)
- Optimal Strategies for TSO balancing in presence of larger uncertainties (PhD student: Martin Nilsson)
- SPINE: EU project concerning system modelling (Post-docs: Dr Manuel Marin, and Dr Jon Olausson)

UK: Imperial College and Strathclyde University, will participate and coordinate UK activities. Key areas of our work in next Phase would include:

- Development of methodologies to analyse and quantify the role and value of flexibility to facilitate cost effective integration of wind generation
- Investigation of alternative ancillary service market designs for systems with significant penetration of wind generation
- Techno-economic assessment of ancillary service provision from alternative wind generation technologies
- Analysis of alternative approaches for quantification of system integration cost of wind generation
- Investigation of the interactions between short-term wind forecasting error and long-term infrastructure investment
- Analysis of the network infrastructure requirements for connection of on and off-shore wind resources
- Review of the transmission\distribution network security standards in the context of cost effective integration of wind generation.

USA: NREL will coordinate the U.S. participation in the Task. They will work on reviewing the methodology/studies made so far in the USA. Specific efforts which will be included in the Task 25 Phase 5 work include:

- Market design. NREL is comparing various market approaches to incentivize flexibility in RT markets. We are also evaluating revenue sufficiency longer-term, at various wind (and solar) penetration rates.
- Flexibility analysis. To evaluate the value of various flexibility options collectively and separately.
- Dynamic studies
- Hydropower flexibility and wind integration
- Active power control from wind turbines and wind power plants
- Large scale studies combining interconnections (SEAMS, NARIS); higher shares wind and solar

The industry (UVIG and GE) will continue to follow up with forecasting practice, market developments and weak grids (Texas, north east, middle of country) as well as grid codes (like ride through for sequential events).

WindEurope will contribute to the work of Task 25 by reviewing relevant integration studies and policies relevant for wind power integration at the European level. As the EU progresses firmly towards the achievement of the 20% of energy demand covered by renewables, larger shares of wind energy are more commonly reported across Member States. Wind Europe will focus on the following topics:

- Balancing services from Wind power plant: understanding wind farms capabilities to provide frequency response in European markets (from primary to replacement reserves). Input to the European Guidelines for cross-border energy balancing (Design of products and procurement recommendations)
- Electrification: market potential, sector integration challenges and opportunities.
- Wind + Storage: Exploring business opportunities, assessment of market trends, etc.
- Wind Energy Generation in Europe: analysis of real production data for understanding capacity credit under system stress periods, relation between wind power and market prices, etc.

Title	Design and operation of power systems with high amounts of wind power Final report of IEA WIND Task 25 phase 4 (2015-17)
Author(s)	Hannele Holttinen et al
Abstract	<p>This report summarises recent findings on wind integration from the 17 countries and Wind Europe participating in the International Energy Agency (IEA) Wind collaboration research Task 25 from 2015–2017. Both real experiences and studies are reported. Many wind integration studies incorporate solar energy, and most of the results discussed here are valid for other variable renewables in addition to wind.</p> <p>The participating countries report increasing shares of wind on average: 43% annual energy in Denmark, about 25% in Ireland, Portugal and in the province of Prince Edward Island in Canada, and more than 30% in Iowa, South Dakota, Kansas, and Oklahoma in the USA. During certain hours more than 100% instantaneous share has been achieved in Denmark and Portugal, more than 80% in Italy and Germany, and the island power system of Ireland has seen 79% of demand, against an allowable 65% share from non-synchronous sources.</p> <p>The national case studies address several impacts of wind power on electric power systems. In this report, they are grouped under long-term planning issues and short-term operational impacts. Long-term planning issues include grid planning and capacity adequacy. Short-term operational impacts include reliability, stability, reserves, and maximising the value of wind in operational timescales (balancing related issues). The first section presents the variability and uncertainty of power system-wide wind power, and the last section presents recent wind integration studies for higher shares of wind power. The appendix provides a summary of ongoing research in the national projects contributing to Task 25 for 2018–2020.</p>
ISBN, ISSN, URN	ISBN 978-951-38-8683-7 ISSN-L 2242-1211 ISSN 2242-122X (Online) DOI: 10.32040/2242-122X.2019.T350
Date	December 2018
Language	English
Pages	124 p. + app. 15 p.
Name of the project	
Commissioned by	IEA TCP WIND
Keywords	grid integration, wind integration, electricity markets, flexibility, capacity value, grid reinforcement
Publisher	VTT Technical Research Centre of Finland Ltd P.O. Box 1000, FI-02044 VTT, Finland, Tel. 020 722 111, https://www.vttresearch.com

Design and operation of power systems with large amounts of wind power

Final summary report, IEA WIND Task 25, Phase four
2015-2017

This report summarises recent findings on wind integration from the 18 countries participating in the International Energy Agency (IEA) technology collaboration programme IEAWind research task number 25. Both real experience and studies are reported. The national case studies address several impacts of wind power on electric power systems. In this report, they are grouped under long-term planning issues and short-term operational impacts. Long-term planning issues include grid planning and capacity adequacy. Short-term operational impacts include reliability, stability, reserves, and maximising the value of wind in operational timescales.

The first section presents the variability and uncertainty of power system-wide wind power, and the last section presents recent wind integration studies for higher shares of wind power. Appendix provides a summary of ongoing research in the national projects contributing to Task 25 from 2018–2020

ISBN 978-951-38-8683-7
ISSN-L 2242-1211
ISSN 2242-122X (Online)
DOI: 10.32040/2242-122X.2019.T350