



INTERPHONE
STAY IN TOUCH

 Bluetooth™

 cellularline

TOUR

USER GUIDE

Chap. 1 - Introduction	3
1.1 Presentation	3
1.2 Warnings	3
1.3 Main specifications	3
1.4 Package contents	3
Chap. 2 - Getting started	4
2.1 Installation instructions	4
2.2 Main commands	4
2.3 - Battery charging	5
2.4 LED indication	5
2.5 Initial ignition (only dual unit version)	5
2.6 Initial ignition (only single unit version)	5
2.7 Voice guide language setting:	5
2.8 Listening priority	5
Chap. 3 - Settings	6
3.1 System settings	6
Chap. 4 – Intercom	6
4.1 Pairing	6
4.1.1: Automatic pairing (GENIUS PAIRING™)	6
4.1.2: Manual pairing	7
4.1.3: Pairing to a PREVIOUS SERIES INTERCOM device	7
4.1.4: Pairing with a NON-Interphone (ANYCOM™) device	7
4.2 Two-unit intercom conversation	7
4.3 Three-unit intercom conversation	7
4.4 Four-unit intercom conversation	7
4.5 Automatic reconnection	7
4.6 VOX Intercom	7
4.7 Warnings and suggestions	7
Chap. 5 - Phone/GPS	8
5.1 Pairing	8
5.2 Telephone use	8
5.3 Sharing a phone call	8
5.4 Warnings and tips for using the phone	8
5.5 GPS	8
Chap. 6 – FM RADIO	9
6.1 Listening to FM radio	9
6.2 FM Mix	9
6.3 "FM radio" function warnings and suggestions	9
Chap. 7 - Music	9
7.1 Playing music	9
7.2 Sharing music	9
7.3 "MUSIC" function warnings and suggestions	9

CHAP. 1 - INTRODUCTION

1.1 Presentation

Thank you for choosing this product. TOUR Interphone is a Bluetooth® helmet device for wireless entertainment and communication between multiple motorcyclists. TOUR Interphone can be installed on most helmets with a quick attachment/detachment bracket. TOUR Interphone is certified to withstand harsh weather, with "IP67" protection level.

1.2 Warnings

BATTERY

Fully charge the battery before using the product for the first time.

Do not store the Product without charging it. Failure to do so may cause irreversible damage to the battery capacity. Charge the battery every TWO months.

IMPERMEABILITY

The external unit (control unit), connected to the audio kit, is classified IP67 according to the IEC60529 standard. The control unit, connected to the audio kit, can therefore be immersed in a metre of fresh water for a maximum of 30 (thirty) minutes.

Despite this classification, the device is not immune to greater stress, such as prolonged immersions or high pressure water jets.

Using the product during intense meteorological phenomena, at high speeds, may be equivalent to subjecting the product to a high pressure jet.

FOLLOW ALL SUGGESTIONS CAREFULLY TO AVOID DAMAGING THE DEVICE:

Do not immerse the product in fresh water which is more than a metre deep for more than 30 minutes. Do not store the product when still wet: dry it with a clean, soft cloth. Dry any water or moisture present in the connector of the control unit and/or audio kit with hot air for at least 10 minutes, so as to prevent the oxidation of the contacts.

Do not expose the product to salt water or ionised water, drinks or other liquids. If the device is exposed to liquids other than fresh water, wash the device with cold fresh water and dry it carefully with a clean, soft cloth.

Do not expose the product to high pressure water jets.

Make sure that the audio kit connector is completely inserted in the control unit. If not, complete protection against water and dust is not guaranteed.

1.3 Main specifications

- **Intercom:** TOUR Interphone allows communication between two motorcyclists of up to a maximum distance of 1.5 km (in open field). The communication between three or four motorcyclists in conference is also possible.
- **Telephone/GPS:** TOUR Interphone can be connected simultaneously to a maximum of two devices (mobile phone/GPS navigators).
- **Radio FM:** TOUR Interphone has an integrated FM-RDS receiver for the 88-108 MHz band. It is possible to store up to 8 stations.
- **Music:** TOUR Interphone can play music from Bluetooth® devices, through A2DP and AVRCP profiles (smartphones, MP3 player etc.).
- **Quick touch™:** TOUR Interphone features a Quick touch™ interface consisting of four keys for direct access to the functions. The single pressing of a button will activate the corresponding function, quickly and intuitively, without the need for a menu.
- **Fast charge™:** TOUR Interphone features quick battery charging technology. A full charging cycle takes 90 minutes and after only 60 minutes it is possible to achieve 80% autonomy.

1.4 Package contents

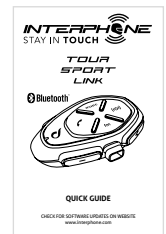
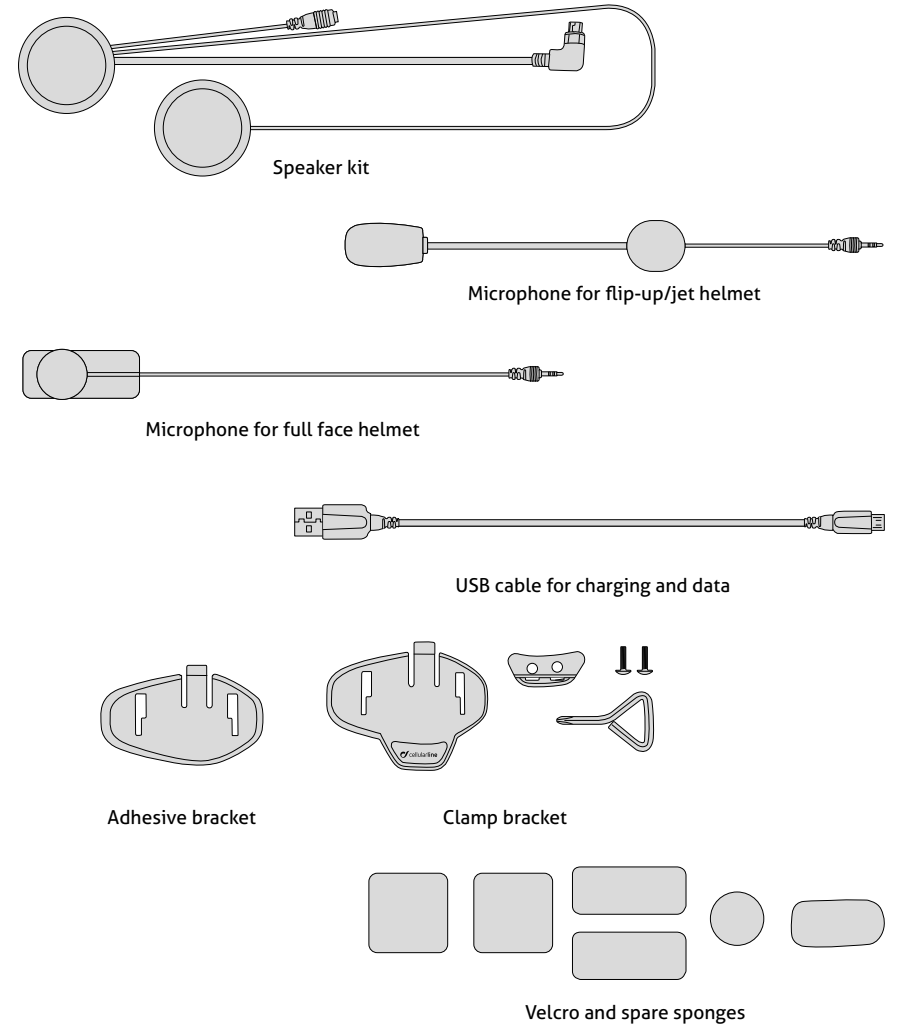

In the dual version, the material shown in the red box is present in the quantities of two pieces for each component.

CHAP. 2 - GETTING STARTED

2.1 Installation instructions

Follow the sequence shown in the figures below for installation of the components.

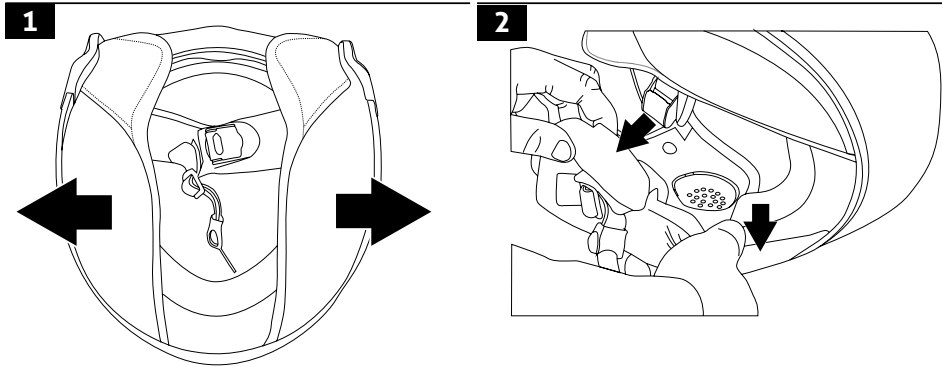

1 If possible, remove the two cushions or padding

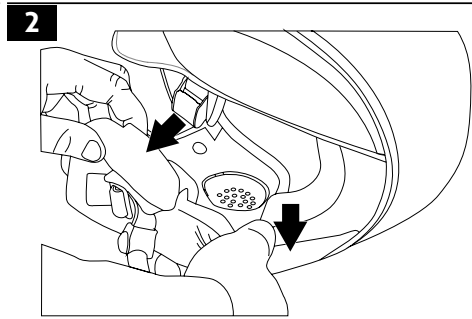

2 Locate the area in correspondence with the ear

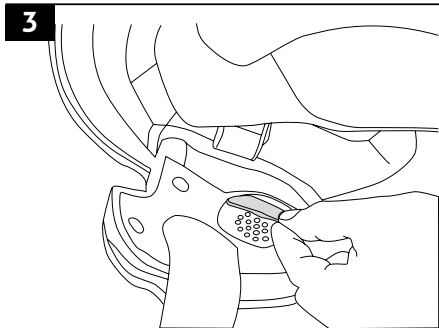

3 Position the strips of Velcro for the speakers

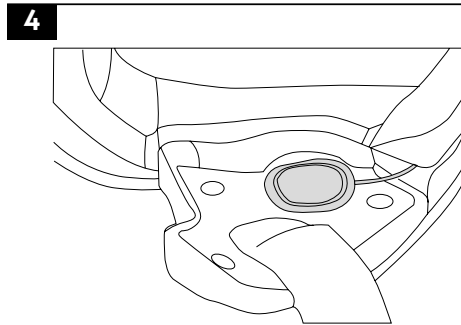

4 Place the speakers

5 Choose the microphone to use:

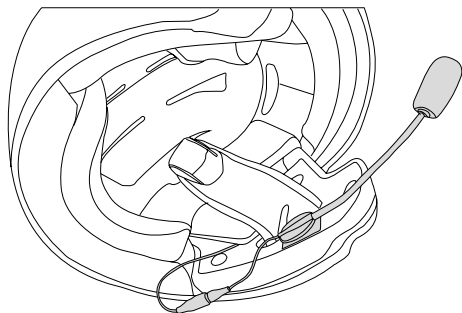

Filp-up/jet helmet

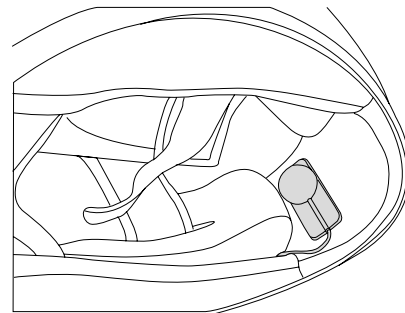

Full face helmet

2.2 Main commands

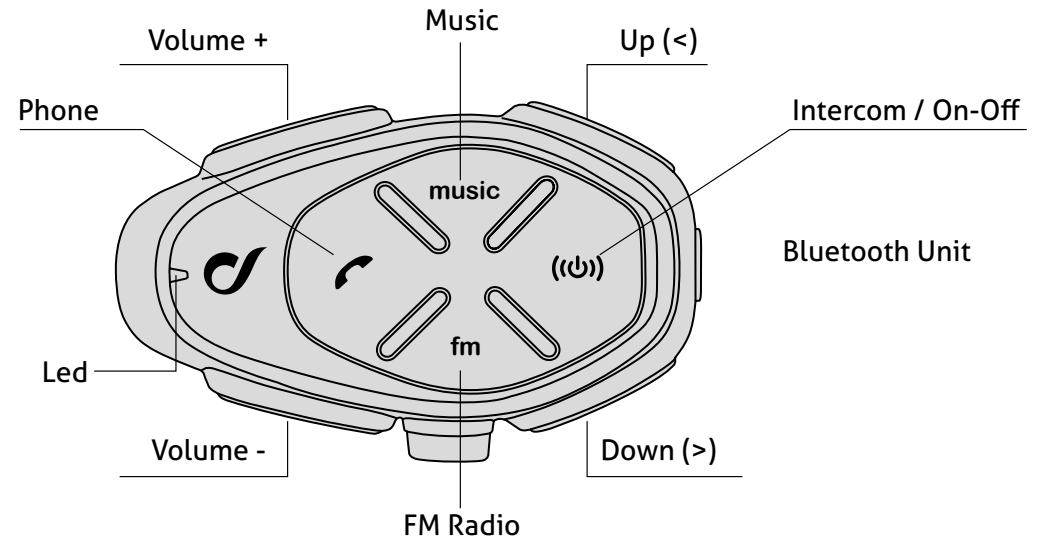

Power On	Press until the blue LED comes on
Power Off	Hold pressed until the red LED comes on and the device turns off
Volume	Press the buttons "Volume +" to increase and "Volume -" to decrease the volume.
Intercom, FM radio, phone and music functions	<p>Press to directly activate (or deactivate) the intercom communication.</p> <p>Press to directly activate (or deactivate) FM radio.</p> <p>Press to directly access the functions of the phone.</p> <p>Press to directly activate (or deactivate) the playing of music.</p> <p>These commands are via direct access. It is therefore possible to move from one function to another with the pressing of a button. It is not necessary to disable a function before moving on to another.</p>

2.3 - Battery charging

Insert the micro USB charging cable into the relevant intercom connector, as shown in the figure. Connect the cable to a standard USB charger.

LED indications:

- red LED: charging.
- mgreen LED: fully charged.

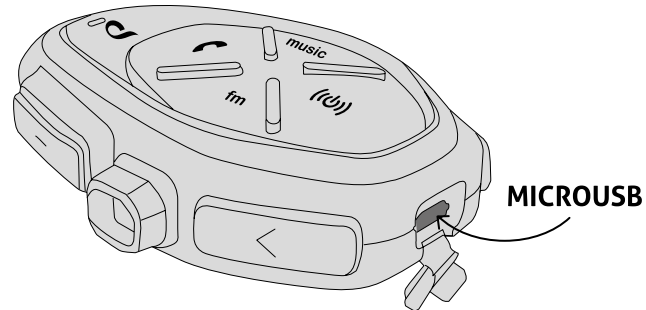

2.4 LED indication

Standby	The BLUE LED flashes approximately every 3 seconds.
Intercom active	The LED turns BLUE with button intensity.
Device connected with phone/GPS	The LED emits a double BLUE flash approximately every 3 seconds.
Playing music from a Bluetooth® source	The LED emits an alternate BLUE flash.
Device in pairing mode	The LED flashes RED/BLUE alternately.
Searching for another Bluetooth® device	The LED flashes RED/BLUE rapidly and alternately.
Settings mode active:	The LED lights up PURPLE.
Charging	The LED comes on RED during charging. The LED comes on GREEN when charging is complete.
Dead battery	The LED lights up RED.

2.5 Initial ignition (only dual unit version)

Press (Ⓜ) on both the units to switch on the devices. The units are already paired by default.

2.6 Initial ignition (only single unit version)

Press (Ⓜ) to turn the unit on. The device will go into "PAIRING MODE". These are the possible choices:

- pairing with Cellularline Interphone devices (see chapter 4.1).
- pairing with intercoms of other manufacturers (see chapter 4.1.4).
- phone or GPS navigation pairing (see chapter 5.1).

2.7 Voice guide language setting:

- With the device turned on, press and hold the UP button (<) until the third beep. The LED will be purple.
- Press + to select the desired language.
- Keep pressing the UP button (<) until the third beep to save the selection. The LED will flash blue.

2.8 Listening priority

The device uses the following priorities in managing the various functions:

1. Mobile phone
2. Intercom (communication with other intercoms)
3. Bluetooth® A2DP audio source (Music from smartphone/Google Maps, MP3 Player etc.)
4. FM radio

This sequence is used by the device to manage the simultaneous use of multiple functions and to choose which function to stop.

Examples:

- if a call is received while listening to music, the latter will be interrupted, automatically switching to the phone audio.
- If an intercom call is received while engaged in a phone call, the latter will not be interrupted.

CHAP. 3 - SETTINGS

Enter settings mode:

With the device turned on, press and hold the UP button (<) until the third beep. The LED will be purple.

Changing the settings:

Pressing each button will change a parameter, according to the figure shown below.

Save the selected settings:

To save the parameters set simply exit the settings mode by keeping pressed the UP button (<) until the third beep. The LED will flash blue.

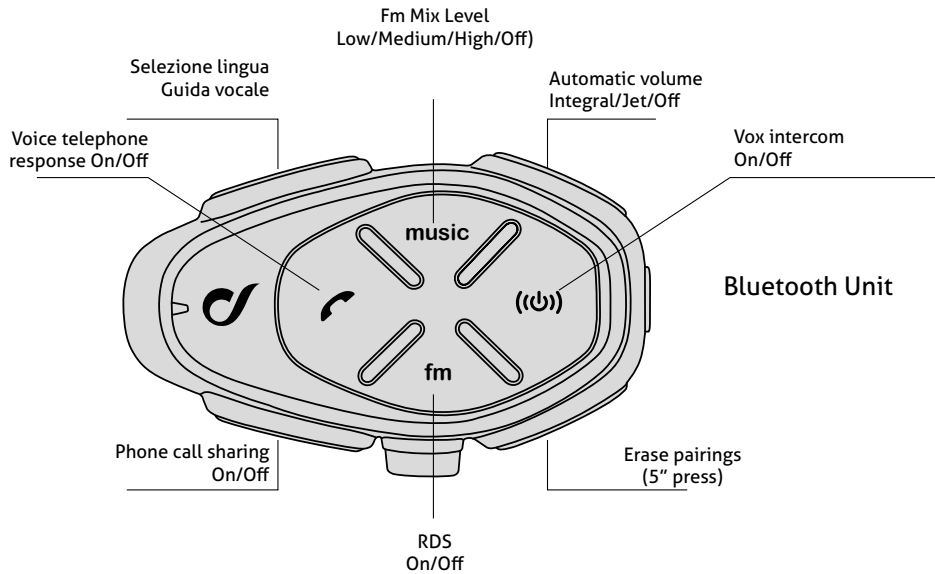

3.1 System settings

- **LANGUAGE SELECTION** each press of the button selects a different language for the voice guidance.
- **FM MIX LEVEL**: each press sets the volume of the radio in the background, on a value between Low/Medium/High/Off. For more details see Chap. 6.2.
- **AUTOMATIC VOLUME: (INTEGRAL/JET/OFF)**: the device can automatically adjust the listening volume, depending on the type of helmet being used. The function can be completely disabled, in which case the user will manually adjust the volume. The maximum audio level possible can be obtained with the AUTOMATIC VOLUME OFF.
- **VOX: (ON/OFF)**: Each press of the button switches the function on/off. See Chap. 4.6 for further details.
- **ERASE PAIRINGS**: press this button for 5 seconds to delete from the memory all previously paired Bluetooth devices. When erasing the pairings, exiting the Settings mode, the device will automatically enter pairing mode, shown in Chap. 2.6.
- **RDS On/Off**: this service allows the device to tune to an alternative frequency when the signal becomes too weak. Each press of the button activates/deactivates the function.
- **PHONE CALL SHARING**: If a phone call is received, the device can share the phone call with another previously paired interphone (see Chap. 5.3). The function is deactivated by default. Each press of the button activates/deactivates the function.
- **VOICE RESPONSE**: Where a phone call is received, it is possible to answer the call with a simple voice command. This function can be switched on/off.

CHAP. 4 – INTERCOM

The device enables the interphone communication (function named "INTERCOM") across multiple devices in conference (several people talking at once).

4.1 Pairing

Before starting the communication between intercoms it is necessary to perform pairing of the various devices. This process will only need to be performed once.

Subsequently the interphone will automatically recognise the previously paired devices.

TOUR Interphone is compatible with the entire INTERPHONE range (including the previous series) and with the ANYCOM function. It is also compatible with the interphones of other manufacturers.

Each TOUR Interphone can be paired to a maximum of two intercoms.



If a device already has two intercoms paired, performing a third pairing will erase the pairing with the first device paired.

4.1.1: Automatic pairing (GENIUS PAIRING™)

The GENIUS PAIRING™ feature allows the fully automatic pairing of up to 4 TOUR Interphone units.

1. Arrange the OFF units (maximum 4) next to one another as shown in the figure.

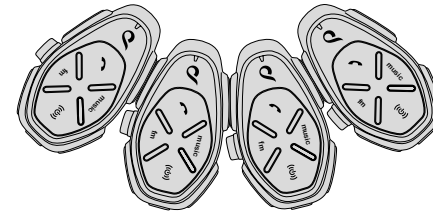

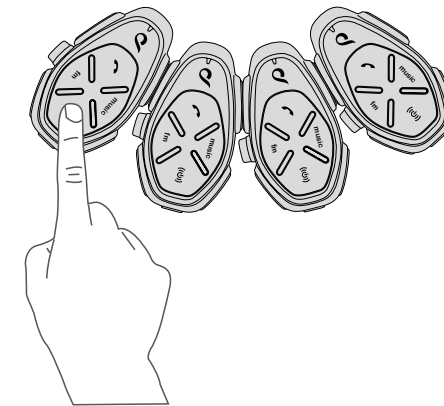

2. On the first unit to the left, press **music** until the LED flashes red/blue. The procedure will end automatically when the last unit has returned to stand-by mode (blue LED every three seconds). All the units are now paired.





3. To start the conference between the recently paired unit follow steps 2 and 3 in Chap. 4.4.



4.1.2: Manual pairing

1. With the intercom off, on each unit, press and hold  until the LED flashes red/blue.
2. Then briefly press  only on one of the two units.



4.1.3: Pairing to a PREVIOUS SERIES INTERCOM device

1. With the second Interphone unit (previous series) off, press and hold the central MFB button until alternate red/blue flashing of the LEDs.
2. With TOUR Interphone off, press and hold  until the LED flashes red/blue.
3. Press briefly  on TOUR Interphone.
4. After a few seconds the units will be paired and the intercom conversation will be started.

4.1.4: Pairing with a NON-Interphone (ANYCOM™) device.

1. In the NON-Interphone unit, start the telephone search/pairing mode; refer to the user manual of the intercom to be paired.
2. With TOUR Interphone off, press and hold  until the LED flashes red/blue.
3. Press  on TOUR Interphone.
4. After a few seconds the units will be paired and the intercom conversation will be started.

4.2 Two-unit intercom conversation

1. Pair unit 1 with unit 2 (Chap. 4.1.2), operation only required the first time.
2. Press briefly  on unit 1 or on unit 2.
3. Press again briefly  on unit 1 or on unit 2 to interrupt the communication.

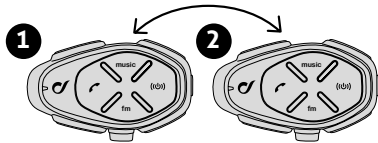

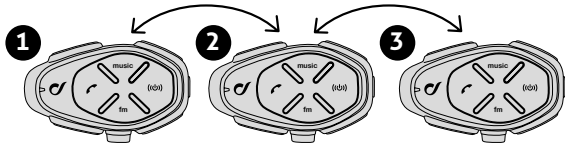

4.3 Three-unit intercom conversation

1. Pair unit 1 with unit 2 and then unit 2 with unit 3 (Chap. 4.1.2), operation only required the first time.
2. Press briefly  on unit 2 to start the conversation in conference between units 1, 2, 3.



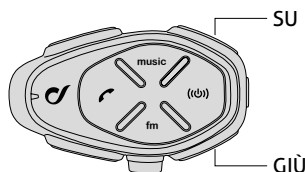

Commands with conference active:

- Press again  on unit 2 to interrupt the conversation in conference.
- Or press  on unit 1 to interrupt the conversation with other units
- Or press  on unit 3 to interrupt the conversation with other units.
- From unit 2, it is possible to call only unit 3 by pressing the "UP" button for 3 seconds, or only unit 1, by pressing the "DOWN" button for 3 seconds



4.4 Four-unit intercom conversation

1. Pair unit 1 to 2, then unit 2 with 3 and finally unit 3 with 4. (Chap. 4.1).
2. Press briefly  on unit 2 to start the conversation in conference between units 1, 2, 3.
3. Press briefly  on unit 4 to start the conversation in conference between units 1, 2, 3 with unit 4.

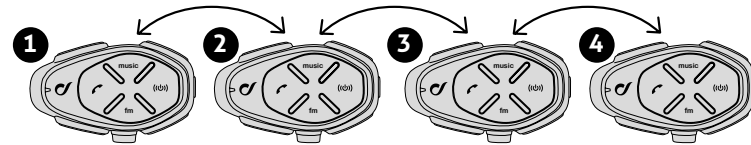

- Press the button  interrupts the conversation between the other units.

4.5 Automatic reconnection

TOUR INTERPHONE has the function of auto reconnection. When the unit is out of range, it will attempt to reconnect. During the search period, an alert message will be heard. After 10 minutes, if reconnection is not successful, the unit will go into Standby mode, interrupting the reconnection attempts. To stop the reconnection attempts, press the button  of one of the units on which auto reconnection is being attempted.

4.6 VOX Intercom

The VOX function allows the device to activate (speaking). To deactivate the function, set "Vox Intercom" on "Off" (see Chap. 3.1).

4.7 Warnings and suggestions

During use in three/four user conference, to ensure the best system stability, avoid connecting other Bluetooth® devices (telephones, GPS, etc.) to the intercom units.

Optimum operation of group conversation is ensured by only using Interphone-branded devices. The audio quality of the "INTERCOM" function is strongly influenced by:

- the correct installation of speakers and microphone inside the helmet.
- surrounding environment (electromagnetic disturbances, natural obstacles etc.).
- the aerodynamic protection features of the motorcycle.
- type of helmet being used.



CHAP. 5 - PHONE/GPS

TOUR Interphone can be connected to Bluetooth® devices, such as mobile phones, GPS and MP3 players. Every TOUR Interphone can be connected simultaneously to up to two Bluetooth® devices (with the exception of using the three- or four-unit INTERCOM function as described in Chap. 4.3/4.4).

5.1 Pairing

Before starting use of TOUR Interphone with these devices, it is necessary to perform pairing of the various devices. This process need only be performed once. Subsequently TOUR Interphone will automatically recognise the devices previously paired and will automatically connect.



Pairing procedure



- 1) Activate the Bluetooth® function on the phone/GPS/MP3 (refer to the device manual for further details).
- 2) With TOUR Interphone in Standby mode (BLUE LED flashing), press together the buttons  +  for 3 seconds to activate "PAIRING mode" (BLUE and RED flashing).
- 3) Start searching for new Bluetooth® devices on the mobile phone / GPS / MP3 reader
- 4) After a few seconds the device will show "F6T"/"Interphone TOUR". Select this option.
- 5) If prompted for a PIN or code, enter 0000 (four zeros).
- 6) The voice guide will confirm successful pairing with the message "SUCCESSFUL PAIRING, CONNECTED TO THE PHONE". The device will go into Standby mode (blue LED flashes twice every 3 seconds).
- 7) If the Bluetooth® device requires authorisation to access the list, provide confirmation.

To pair a second device, repeat the procedure from step 1).

5.2 Telephone use

As specified in section 2.8, a phone call has the highest priority than any other TOUR INTERPHONE function. In case of receipt of a phone call use the commands shown in the following table:

Answering a call	In case of an incoming call, press the  button or say a word out loud (voice activated response Chap. 3.1)
To end a call	To end a call press the  button or wait for the other person to end the call.

Voice call	Press  to activate the voice call
Redialling last number	Press the  button until the beep (1.5 seconds) to redial the last number.
Quick call	Press the  button until the second beep (3 seconds) to call the number set.

5.3 Sharing a phone call

TOUR Interphone has a telephone conference function. During a phone call it is possible to add a previously paired intercom (Chap. 4.1).

"Call sharing" is disabled by default. To enable it, refer to "Chapter 3-SETTINGS".

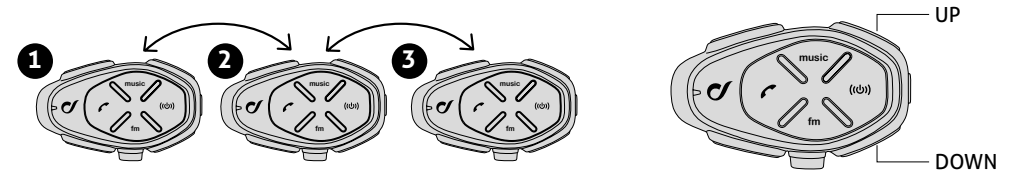

Start/Stop call sharing (from unit 2)

Press the UP button until the second beep to start/stop sharing with unit no. 3.

Press the DOWN button until the second beep to start/stop sharing with unit no. 1.

5.4 Warnings and tips for using the phone

If two different mobiles are connected at the same time, the functions "Redial last number" and "Voice call" may only be used by the first phone connected.

An Internet connection on the mobile phone may be needed to use the "Voice call".

The "Voice call" function may not be supported by your mobile phone (refer to your device manual for further details).

5.5 GPS

After pairing the TOUR Interphone to the GPS (Chap. 5.1) it is possible to hear the voice prompts sent by the navigator. During the intercom communication the GPS (if fitted) will interrupt the conversation whenever it is necessary to transmit a voice prompt.



Attention: ensure the GPS is compatible with the Bluetooth® headsets. Consult the GPS user manual for further information.

TOUR Interphone uses the Bluetooth® HFP profile to manage the connection to a GPS unit.

Navigators integrated within smartphones use the A2DP profile to send route directions. This profile does not allow interruption of the intercom conversation.

Navigators sold for use in cars are NOT usually equipped with Bluetooth® HFP. For that reason they cannot transmit voice prompts to Bluetooth® headsets. Consult the GPS user manual for further information.

CHAP. 6 – FM RADIO

TOUR Interphone has integrated FM radio with RDS and 8 stations that can be saved

6.1 Listening to FM radio

Radio on/off	Press the fm button.
Forward/backward station search	Press the UP/DOWN button to start the forward/backward search (from 88 MHz to 108 MHz) for a station.
Memory selection	Press the UP button until the beep to select the next saved station.
	Press the DOWN button until the beep to select the previous saved station.
Saving a station	Press the button fm until the beep (1.5 seconds) to save the station being listened to.
	Press the UP or DOWN button to select the memory (from no. 1 to no. 8) to save the station.
	Press the button fm to confirm the memory (from no. 1 to no. 8).
Automatic Saving Temporary (A.T.S.™ technology)	Press the button fm until the beep (3 seconds) to save the 8 stations with the optimum frequency Saving is temporary and the stations will be deleted when the TOUR Interphone is restarted.

6.2 FM Mix

The FM Mix function allows listening to FM radio in the background during a conversation with another intercom. To activate it, it is necessary to set the FM Mix volume to a value between "Low/Medium/High" (see Chap. 3.1). This parameter sets the background volume of the radio during the conversation. With the conversation completed, the FM radio volume increases to the standard level set.

To deactivate the function, set the FM Mix volume on "Off" (see Chap. 3.1).

6.3 "FM radio" function warnings and suggestions.

TOUR Interphone has an FM receiver with RDS. This feature is used:

- when the tuned broadcast signal becomes too weak, TOUR Interphone will attempt to tune in to an alternative frequency used by the same station.



In case the signal of the current station is not weak enough to trigger the search for an alternative station, it is possible that listening will be characterised by disturbances due to poor signal strength. FM reception is strongly influenced by the surrounding environment (electromagnetic disturbances, natural obstacles etc.).

CHAP. 7 - MUSIC

TOUR Interphone can play music from Bluetooth® devices (smartphones, MP3 players etc.) equipped with A2DP profile. To play music it is necessary to pair the devices to TOUR INTERPHONE (Chap. 5.1)

7.1 Playing music

Play/Pause	Press the music button to start/stop playback of music
Track selection	Press the UP or DOWN button to select the next or previous track.

7.2 Sharing music

TOUR Interphone has a "SONG SHARING" function which allows music sharing with another Interphone.

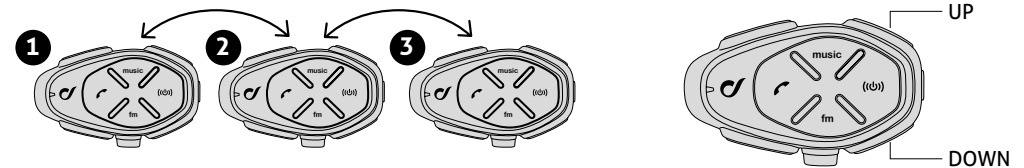

Start/Stop sharing	Press the UP button until the second beep to start/stop music sharing with Interphone 3.
	Press the DOWN button until the second beep to start/stop music sharing with Interphone 1.

During music sharing, by pressing the button **(iob)** it is possible to start an intercom communication.

7.3 "MUSIC" function warnings and suggestions.

- Only Bluetooth® devices with A2DP profile can transmit stereo music to the device.
- Only Bluetooth® devices with AVRCP profile can be controlled at a distance from the device.
- The sound quality of the music also depends on the quality of the audio source (bitrate and codec of audio files, Bluetooth® player quality etc.).

TECHNICAL SPECIFICATIONS:

Bluetooth® compliance:	Bluetooth® v. 4.2 - Classe II
Supported Bluetooth profiles:	HFP / A2DP / AVRCP
Dimensions mm:	55x85x25
Weight:	68 g
Capacity:	Up to 10 metres
Talk time:	20h
Stand-by time:	1000 h
Charging time:	1,5 h
Battery type:	Lithium-ion rechargeable

**Federal Communications Commission (FCC) Statement
Industry Canada (IC) Statement**

15.21 You are cautioned that changes or modifications not expressly approved by the part responsible for compliance could void the user's authority to operate the equipment.

15.105(b) This equipment has been tested and found to comply with the limits for a Class B digital device, pursuant to part 15 of the FCC/IC rules. These limits are designed to provide reasonable protection against harmful interference in a residential installation. This equipment generates, uses and can radiate radio frequency energy and, if not installed and used in accordance with the instructions, may cause harmful interference to radio communications. However, there is no guarantee that interference will not occur in a particular installation. If this equipment does cause harmful interference to radio or television reception, which can be determined by turning the equipment off and on, the user is encouraged to try to correct the interference by one or more of the following measures :

- Reorient or relocate the receiving antenna.
- Increase the separation between the equipment and receiver.
- Connect the equipment into an outlet on a circuit different from that to which the receiver is connected.
- Consult the dealer or an experienced radio/TV technician for help.

This device complies with part 15 of the FCC rules and Industry Canada licence-exempt RSS standard(s)

Operation is subject to the following two conditions :

- 1) This device may not cause interference and
- 2) This device must accept any interference, including interference that may cause undesired operation of the device.

FCC/IC RF Radiation Exposure Statement :

This equipment complies with FCC/IC radiation exposure limits set forth for an uncontrolled environment. End users must follow the specific operating instructions for satisfying RF exposure compliance. This transmitter must not be co-located or operating in conjunction with any other antenna or transmitter.

SAR is measured with the device at 0 mm to the body, while transmitting at the highest certified output power level in all frequency bands of the device. The maximum SAR value is 1.75 W/kg (head/body) averaged over 10 gram of tissue.



WARNING: To prevent possible hearing damage, do not listen at high volume levels for long periods.



**EN - INSTRUCTIONS FOR THE DISPOSAL OF APPLIANCES
FOR DOMESTIC USERS**

(Applicable in countries in the European Union and those with separate waste collection systems)
This mark on the product or documentation indicates that this product must not be disposed of with other household waste at the end of its life. To avoid any damage to health or the environment due to improper disposal of waste, the user must separate this product from other types of waste and recycle it in a responsible manner to promote the sustainable re-use of the material resources.

Domestic users should contact the dealer where they purchased the product or the local government office for all the information regarding separate waste collection and recycling for this type of product. Corporate users should contact the supplier and verify the terms and conditions in the purchase contract. This product must not be mixed with other commercial waste.

This product has a battery that cannot be replaced by the user. Do not attempt to open the device to remove the battery as this could cause malfunctions and seriously damage the product. When disposing of the product, please contact the local waste disposal authority to remove the battery. The battery inside the device was designed to be able to be used during the entire life cycle of the product



EN - Hereby, Cellular Italia S.p.A declares that the radio equipment type BTF6 (Interphone Tour, Sport and Link) is in compliance with Directive 2014/53/EU and Directive ROHS (2011/65/EU). The user is prohibited from making any type of change or variation to the device.

Variations or changes not expressly approved by Cellular Italia S.p.A will cancel the user's authorisation to use the device.

Only update with software provided by Cellular Italia S.p.A.

Bluetooth® is a trademark owned by Bluetooth SIG, Inc.

The full text of the EU declaration of conformity is available at the following internet address: www.cellular-line.com/it_it/dichiarazione-conformita/