



AJP SPR 125 USER MANUAL



AJP Motos, SA - Disclaims all liabilities for any errors or omissions present in this manual and reserves the right to make changes that reflect the on-going development. Illustrations and diagrams in this document can differ from the genuine components. The partial or full reproduction of this document is not allowed without written authorization.

1st. Edition (July 2022)

Copyright by

AJP Motos, SA

Technical Service

Rua de Santana, 91

4620-510 Pias, Lousada

Portugal

Tel: +351 255 815 122

Fax: +351 255 815 123

Website: www.ajpmotos.com

1st. Edition (July 2022)

! IMPORTANT INFORMATION !

WE STRONGLY RECOMMEND YOU TO READ THIS MANUAL CAREFULLY AND COMPLETELY BEFORE GOING ON YOUR FIRST RIDE. THE MANUAL CONTAINS A GREAT DEAL OF INFORMATION AND ADVICES, WHICH WILL HELP YOU USE AND HANDLE YOUR MOTORCYCLE PROPERLY. IN YOUR OWN INTEREST, PLEASE PAY ATTENTION TO NOTICES THAT ARE MARKED AS FOLLOWS:

DANGER

IGNORING THESE INSTRUCTIONS CAN ENDANGER YOUR PHYSICAL INTEGRITY AND YOUR LIFE, AS WELL AS OTHERS.

WARNING

IGNORING THESE INSTRUCTIONS CAN DAMAGE PARTS OF YOUR MOTORCYCLE AND/OR MAKE THE MOTORCYCLE NO LONGER SAFE TO RIDE ANYMORE.

- TAKE SPECIAL CARE TO FOLLOW THE RECOMMENDED RUN IN, INSPECTION AND MAINTENANCE INTERVALS. FOLLOWING THESE GUIDELINES WILL SIGNIFICANTLY INCREASE THE LIFE OF YOUR MOTORCYCLE. BE SURE TO HAVE ANY MAINTENANCE JOBS PERFORMED BY AN AUTHORIZED AJP DEALER.
- PLEASE DON'T FORGET TO WEAR A HELMET, EYE PROTECTION AND PROTECTIVE CLOTHING WHEN GOING FOR A RIDE.
- AJP MOTOS RESERVES THE RIGHT TO MODIFY ANY EQUIPMENT, TECHNICAL SPECIFICATIONS, COLOURS AND MATERIALS USED WITHOUT PREVIOUS ANNOUNCEMENT AND WITHOUT GIVING REASONS, OR TO CANCEL ANY OF THE ABOVE ITEMS WITHOUT SUBSTITUTING THEM WITH OTHERS.

- IT SHALL BE ACCEPTABLE TO STOP MANUFACTURING A CERTAIN MODEL WITHOUT PREVIOUS ANNOUNCEMENT. IN THE EVENT OF SUCH MODIFICATIONS, PLEASE CONTACT YOUR LOCAL AJP DEALER FOR INFORMATION.
- WE SHALL NO BE HELD LIABLE FOR ANY PRINTING ERRORS

WE WISH YOU ENJOY YOUR AJP!

TABLE OF CONTENTS

TABLE OF CONTENTS	vi
Chapter A. CONSUMER INFORMATION	A.1
ACCESSORY INSTALLATION AND SAFETY TIPS	A.2
SAFE RIDING RECOMMENDATIONS	A.4
MOTORCYCLE IDENTIFICATION	A.5
BREAKING-IN	A.6
INSPECTIONS BEFORE RIDING	A.7
RIDING TIPS	A.9
MOTORCYCLE CLEANING	A.14
STORAGE PROCEDURES	A.16
CONSERVATION FOR WINTER OPERATION	A.17
Chapter B. COMPONENTS LOCATION	B.1
CONTROLS	B.5
Chapter C. MAINTENANCE SCHEDULE	C.1
Chapter D. MAINTENANCE AND ADJUSTMENTS	D.1
LUBRIFICATION POINTS	D.2
CHECKING ENGINE OIL LEVEL	D.3
CHANGING ENGINE OIL	D.4
CHECKING SPARK PLUG	D.5
CHECKING AND ADJUSTING THE STEERING HEAD BEARINGS	D.6

CLEANING FRONT FORK DUST SEALS.....	D.6
ADJUSTING FRONT FORK SUSPENSION.....	D.7
ADJUSTING REAR SUSPENSION.....	D.8
ADJUSTING DRIVE CHAIN.....	D.1
DRIVE CHAIN MAINTENANCE	D.2
TIRES CONDITION	D.3
TIRES PRESSURE.....	D.3
CHECKING SPOKES TENSION.....	D.4
BRAKE DISCS	D.5
BRAKE PADS.....	D.5
CHECKING FRONT BRAKE PADS	D.6
CHECKING REAR BRAKE PADS.....	D.6
FRONT BRAKE MASTER CYLINDER	D.7
CHECKING FRONT BRAKE FLUID LEVEL	D.7
REFILLING FRONT BRAKE FLUID.....	D.8
CHECKING REAR BRAKE FLUID LEVEL.....	D.8
REFILLING REAR BRAKE FLUID	D.9
CHANGING REAR BRAKE PEDAL POSITION	D.9
REMOVING THE BATTERY	D.10
RECHARGING THE BATTERY.....	D.11
FUSES.....	D.12
REPLACING HEADLIGHT LAMP.....	D.13

REPLACING TAILLIGHT (1).....	D.14
REPLACING LED TURN SIGNALS (2).....	D.14
CLEANING AIR FILTER	D.15
CHECKING EXHAUST SYSTEM.....	D.16
Chapter E. TECHNICAL SPECIFICATIONS.....	E.17

Chapter A.

CONSUMER INFORMATION

ACCESSORY INSTALLATION AND SAFETY TIPS

ACCESSORIES AND MODIFICATIONS

In the market there is a variety of accessories for SPR 125 motorcycles. AJP cannot have direct control over the quality or suitability of accessories you may want to purchase. The addition of unsuitable accessories can lead to unsafe operating conditions. Contact your AJP dealer to assist you in selecting accessories and install them correctly.

DANGER

- Improper accessories or modifications can make your motorcycle unsafe and can lead to an accident.**
- Never modify the motorcycle with improper or poorly installed accessories.**
- Follow all instructions in this manual regarding accessories and modifications.**
- Consult your AJP dealer if you have any questions.**

Certain accessories displace the rider from his normal position, which limit the freedom of movement and may limit the motorcycle control ability.

Additional electric accessories may overload the electric system. Severe overloads may damage the wiring harness or create a dangerous situation due to the loss of electric power during the operation of the motorcycle.

When carrying additional load on the motorcycle, mount the load as low as possible. An improperly mounted load can create a high center of gravity, making the motorcycle dangerous and difficult to handle. The size of the load can also affect the aerodynamics and handling of the motorcycle. Balance the load between the left and right sides of the motorcycle and fasten it securely.

BURNS

Some vehicle components become very hot when the vehicle is operated.

DANGER

Do not touch any parts such as exhaust system, engine, shock absorber, or brake system before the vehicle parts have cooled down.

Let the vehicle parts cool down before you perform any work on the vehicle.

ENVIRONMENT

If you use your motorcycle responsibly, you can ensure that problems and conflicts do not occur. Make sure that you use your motorcycle legally, display environmental consciousness, and respect the right of others.

WARNING

When disposing of used oil, other operating and auxiliary fluids, and used components, comply with the laws and regulations of the respective country.

Note: For addition information consult our website: www.ajpmotos.com

SAFE RIDING RECOMMENDATIONS

WEAR A HELMET

Motorcycle safety equipment starts with a quality helmet. One of the most serious injuries that can happen is a head injury. ALWAYS wear a properly homologated helmet. You should also wear suitable eyes protection.

RIDING CLOTHING

Loose or inappropriate clothing can be uncomfortable and unsafe for motorcycle riding. Choose good quality motorcycle riding apparel when riding your motorcycle. Wear gloves, strong boots that protect the ankle, long pants and long sleeve shirt/jacket. Never wear loose-fitting clothes, otherwise they could catch on the control levers, footrests or wheels and cause injury or an accident.

INSPECTION BEFORE RIDING

Review all the instructions in the “INSPECTIONS BEFORE RIDING” section in this manual. Do not forget to perform an entire inspection to ensure the safety of the motorcycle.

FAMILIARIZE YOURSELF WITH THE MOTORCYCLE

Your riding skill and your mechanical knowledge form the basis for safe riding. We recommend you to practice riding your motorcycle in an open area without obstacles until you are familiar with your motorcycle and its controls.

KNOW YOUR OWN LIMITS

Always ride within the limits of your skills. Knowing your limits and keep within them are the foundation to avoid accidents and injuries.

BE EXTRA SAFETY CONSCIOUS ON BAD WEATHER DAYS OR BAD ROAD CONDITIONS

Riding on bad weather days requires extra attention. Braking distances double in a rainy day. If you are not sure about road conditions ride slower and with double caution!

MOTORCYCLE IDENTIFICATION

Chassis and engine serial numbers are used for the motorcycle registration. Alongside, it should be used by the AJP dealers to perform the request AJP MOTOS spare parts.

HOMOLOGATION PLATE

Homologation plate (1) of the motorcycle is located on the frame left side. The plate contains the homologation number, serial number and the noise level at a specified engine rpm.

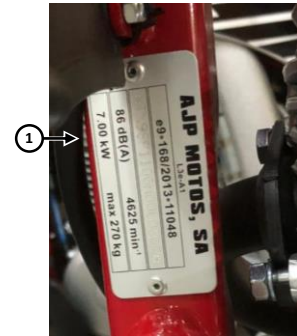

CHASSIS/FRAME NUMBER

Chassis number (2) is engraved on the right side of the steering column.

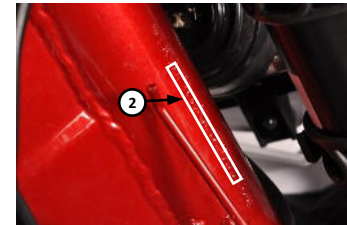

ENGINE SERIAL NUMBER

Engine serial number (3) is engraved on the left side of the engine, below the engine sprocket, between gearshift lever and the oil cap.



BREAKING-IN

The following recommendations show the importance of a proper break-in to achieve maximum life and performance for the new AJP model.

Even high precision machined sections of engine components have rougher surfaces that require be operated with the other component surfaces, in order to adjust to each other. Therefore, every engine needs to be broken-in during the first 1000 km.

For this reason, do not load the engine more than 50% of its capacity during the first 500 kilometers and avoid full throttle. After 500 km, you can load the engine up to 75% of its capacity, using the gearbox frequently.

Allow sufficient idling time (1-2 minutes) with a cold or warm engine start up, before applying load or revving the engine. This procedure allows the lubrication oil to reach all critical engine components.

The first 1000 km maintenance service is the most important maintenance that your AJP will receive. The motorcycle must be checked carefully, restoring all the adjustments and retightening fasteners.

WARNING

Incorrect break-in may cause severe damage of components or significantly reduce the motorcycle life time.

INSPECTIONS BEFORE RIDING

In each start off, the engine must be in perfect mechanical conditions. For safety reasons, the owner/driver should make overall check routine before each ride. The following inspections should be performed:

1. **Oil level:** Insufficient oil quantity will result in premature wear in engine components, damaging the engine itself;
2. **Fuel:** Check if there is enough fuel in the tank;
3. **Drive chain:** Verify the drive chain clearance and condition. A chain with incorrect tension or lack of lubricant can result in excessive wear and damage other components. Aside from resulting in premature wear, the chain or transmission axle may break;
4. **Tires:** Check the air pressure and the existence of cuts or punctures in the tires, replace the tires if necessary. The tread must also follow the legal restrictions. Insufficient tread and incorrect air pressure will reduce the driving performance;
5. **Brakes:** Inspect the braking system and brake fluid level. The fluid level below the minimum mark can indicate a possible fluid leak or completely worn pads. Also check the brake hoses and the brake linings thickness, as well the free play of the brake lever and pedal;
6. **Electric system:** Check correct function lights, indicators and horn while the engine is running;
7. **Steering:** Check for smoothness, restriction of movement and steering column bearings looseness;
8. **Throttle:** With the engine off, inspect the correct play, smooth operation and the return to close position. The throttle grip must rotate freely without any obstacle;
9. **Clutch:** Examine for correct play, smoothness and progressive action;
10. **Suspension:** Inspect suspensions for soft movements;
11. **Emergency switch:** Check for the correct function of the emergency switch, by turning off the engine with the switch.
12. **Luggage:** In case of taking any luggage, check if it is safety secured.

DANGER Ignoring these inspections or improperly preserve the motorcycle will increase the chance of an accident or component damage.

DANGER Using worn, improperly inflated or incorrect tires will reduce motorcycle stability and potentiate an accident.
Front and rear tires are only allowed to be fitted with same homologated original profile tires.

DANGER Wear suitable clothing when driving a motorcycle. Never forget to wear helmet, gloves and boots, even in short trips. Protective clothing should be brightly colored to make you visible to other drivers.
Do not drive after consuming alcohol.

DANGER Never ride your motorcycle on full throttle or high rotations while the engine is cold. Otherwise the piston will be warming up faster that the cylinder, which can cause severe engine damage.
Checking maintenance items with a running engine can be dangerous. You can be severely injured if your hands or clothing get caught in moving parts, such as tires or drive chain.

DANGER Observe the traffic regulation and drive defensively, trying to look ahead as far as possible to early recognize any possible obstacle.
Adjust your driving speed according to the conditions and driving skills. Drive carefully in unknown roads or trails, if possible with company in case of any problem occur.
Replace helmet visor or goggle lens when scratched or damaged. Do not repair twisted handlebar, replace it immediately.

RIDING TIPS

INSTRUCTIONS FOR INITIAL OPERATION

- Verify if your AJP dealer performed a previous preparation of the motorcycle.
- Familiarize yourself with all operating motorcycle controls. Get used to the handling on an empty and open space before longer rides. Try also drive as slow as possible to improve your feeling of the motorcycle.
- Hold the handlebar with both hands and maintain your feet on the footrest while driving.
- Remove your foot from the brake pedal when you are not braking. Otherwise the brake system overheat.
- For safety reasons do not modified the vehicle and always use AJP original spare parts.
- Motorcycle are sensitive to changes in weight distribution. In case of caring luggage with you, secure it as close as possible to the middle to distribute weight on both sides.

ENGINE START

1. Raise up the side stand and turn the ignition key to ON position.
2. Engage the neutral gear (the neutral indicator should be on).
3. Check if the emergency switch is in the ON position.
4. Actuate the electric starter motor button without operating the throttle grip.

DANGER

Before start off check if the side stand is fully folded up. Otherwise, the side stand can drag on the ground causing control loss.

Always turn on the lights to make sure that other drivers become aware of you as early as possible.

Never ride your motorcycle with full load or rev the engine when cold. Due to premature heating of the piston under these conditions, the engine can suffer serious damage.

WARNING

Never operate the electric starter more than 5 seconds. Wait at least 10 seconds before trying again.

In some particular conditions, some extra fuel may go to the engine. If engine “floods”, open throttle during 3 seconds before start engine; if engine does not start, wait 10 seconds and try again. After five trials, if engine does not start, check spark plug, dry it and try again. If engine does not start replace spark plug for a new one.

DANGER

Do not start the engine or allow it to idle in a closed area. Exhaust gases are poisonous and can cause loss of consciousness and even death. Always provide adequate ventilation while the engine is running.

Never leave engine running for a more than 5 minutes while the motorcycle is parked: engine will overheat and severe damage may occur

STARTING OFF

1. Press the clutch lever and put the engine in first gear.
2. Slowly release the clutch lever and open the throttle at the same time.

USING THE GEARBOX

The first gear is referred as the start off or uphill gear. Depending on the conditions (traffic, surface inclination, etc.) you should shift to the suitable gear. To shift between gears, simultaneously close throttle and operate the clutch lever, while operating the gearshift pedal to switch gears.

Let clutch go again and give gas. When you reach full speed by opening the throttle all the way, turn throttle back to $\frac{3}{4}$; the speed hardly decreases and the engine will use less fuel.

Only give as much gas as the engine can handle. Through quick and high revving of throttle, the fuel consumption increases.

High rpm rates in a cold engine will reduce the engine lifetime. We recommend to run the engine in moderate rpm on first 10 km (6 miles), giving it the chance to warm up.

Never shift down gears with throttle wide open. The engine will over-rev, damaging the valves and the gearbox.

If any abnormal vibrations occur while driving, check for loosen bolts in the engine. If the vibration remains contact an AJP dealer.

If noticed any unusual operation-related noise while riding, stop immediately. Shut the engine off and contact an AJP dealer, and if necessary/possible tow the motorcycle up to the dealer.

Never start your motorcycle without air filter placed, otherwise dust and dirt may penetrate the engine creating premature wear or damaging it.

WARNING

BRAKING

Apply both brakes at the same time while closing the throttle. When driving on sandy, wet or slippery ground use mainly the rear brake. Avoid blocking the wheels, otherwise you may lose control of the motorcycle.

Use the engine brake effect when driving downhill to assist the brakes. Lower one or two gears without over-speeding the engine. Therefore, you will not need to use continuously the brakes, avoiding overheat.

DANGER Each time you brake, brake discs, pads, calipers and brake fluid heat up. The hotter these parts get, the weaker the braking effect; in extreme cases, the entire braking system can fail.

DANGER In case of rain, washing the motorcycle or ride through wet off-road tracks, the wet or dirty brake discs can delay the braking effect. Brakes must be actuated until the brake discs are dry and/or clean.

Dirty brakes cause increased wear of brake pads and discs.

DANGER Hard braking on wet, rough or slippery surfaces can cause wheel skid and control loss. Brake slightly and carefully on adverse or irregular surfaces.

Hard braking while turning may cause wheel slide and control loss. Brake before starting to turn.

DANGER Using only front or rear brake can cause skidding and control loss. Inexperienced riders tend to under use the front brake. This can cause increased braking distance and lead to collisions.

STOPPING AND PARKING

In order to stop apply the brakes until the motorcycle is immobilized. To turn off the engine turn the key to OFF position on the ignition switch or press the emergency switch to the OFF position. Park the vehicle on solid ground and in a secure position. Lock the steering.

DANGER

Never leave the motorcycle without supervision while the engine is running or with children nearby.

Do not touch the motorcycle components after a ride. The components as engine, exhaust pipe, brakes and others can remain with high temperatures and cause burns.

Be careful when parking the vehicle. Place on areas out of reach of pedestrians and easy flammable materials to avoid burns and fire risks.

MOTORCYCLE CLEANING

Clean your motorcycle often in order to maintain the appearance of plastic surfaces and avoid corrosion. During cleaning avoid direct sunshine on the motorcycle.

Materials damages

WARNING

Avoid using a high pressure washer. Never direct a high pressure jet to some sensitive points of motorcycle, such as electronic components (CDI, switches, relays, connectors, controls cables, among others), wheels and steering column bearings.

The recommended method would be to use a sponge and warm water at 30-35°C mixed with a regular washing detergent. The hard dirt can be removed before washing with the help of a soft water jet.

Environment

DANGER

Hazardous substances cause environmental damage. So you should dispose the oils, grease, filters, fuel, cleaning agents, brake fluid, etc., correctly and in compliance with the applicable regulations.

Recommendations

- Use a regular cleaning detergent to wash the motorcycle. Especially dirty parts should be cleaned with the help of a brush;
- Before cleaning with water, cover the muffler and the air filter cover holes to prevent water going inside;
- After cleaning with a soft water jet, dry the motorcycle with compressed air and a piece of fabric. Remove the materials used to cover up the muffler and air filter cover holes, then start the engine and let it run for few minutes;

- Take a short drive until the engine reach the operating temperature and use the brakes. Doing this procedure the residual water will evaporate due the warm parts off engine and brakes;
- Once the motorcycle has cooled down, lubricate all sliding and bearings points. Lubricate as well the chain with a chain spray;
- To avoid any malfunction of the electric system, you should apply spray on the emergency switch, starter motor button, light switch and connectors with a contact spray.

STORAGE PROCEDURES

In case of motorcycle storage for long period of time, the following instructions should be take:

- Clean the motorcycle thoroughly (see MOTORCYCLE CLEANING);
- Remove the spark plug and fill the cylinder with approximately 5 cc of engine oil through the opening. Assembly the spark plug, without the spark plug cap connected, and actuate the start motor in order to distribute the oil into the cylinder walls;
- Remove the fuel into an appropriate container;
- Correct the tire pressure;
- Lubricate pivot points of control levers, foot rests and others, as well as the chain;
- Remove the battery (see REMOVING THE BATTERY);
- Storage on a dry place where the motorcycle is not subject to excessive temperature fluctuations;
- Cover the motorcycle with a blanket. Do not use air impermeable materials, otherwise humidity might be retained and cause corrosion.

WARNING

Do not let engine run in short time period (less than 5 minutes). Without warming enough the engine, water vapor will condense while cooling down, causing valve and exhaust corrosion.

RE-INITIATION AFTER STORAGE OR EXTENDED STOPPED PERIOD

- Assembly the charged battery (check polarity);
- Fill up the fuel tank with fresh fuel;
- Check the motorcycle before each start (see INSPECTIONS BEFORE RIDING)

CONSERVATION FOR WINTER OPERATION

In case of using the motorcycle in winter and on road where salt spray was applied, additional precautions measures must be taken against the aggressive road salt.

WARNING

Clean the motorcycle thoroughly and dry completely after each ride.

Treat the engine, swing arm and all other galvanized parts (except for brake disks) with a wax based anti-corrosion agent.

Chapter B.

COMPONENTS LOCATION



1.	Headlight	6.	Front Tire	11.	Rear suspension
2.	Front suspension	7.	Front brake caliper	12.	Drive chain
3.	Fuel tank	8.	Engine	13.	Swing Arm
4.	Fuel tank cap	9.	Gearshift pedal		
5.	Turn signals (blinkers)	10.	Chassis		

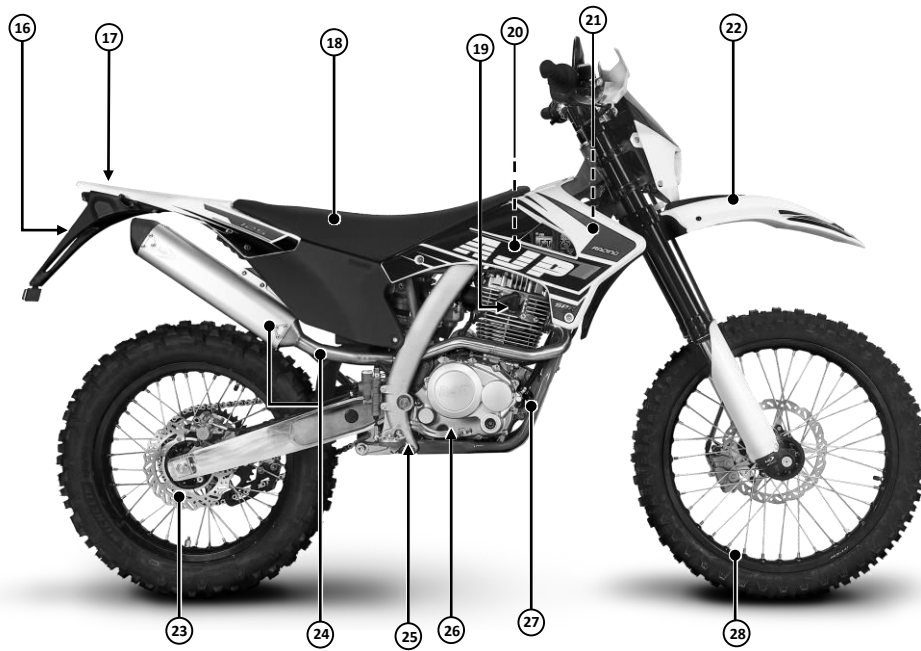

16.	Number-plate holder	21.	Battery	26.	Rear brake pedal
17.	Taillight	22.	Front Fender	27.	Engine Skid Plate
18.	Seat	23.	Rear brake disc	28.	From rim
19.	Spark plug	24.	Exhaust system		
20.	Fuses	25.	Foot-rest		

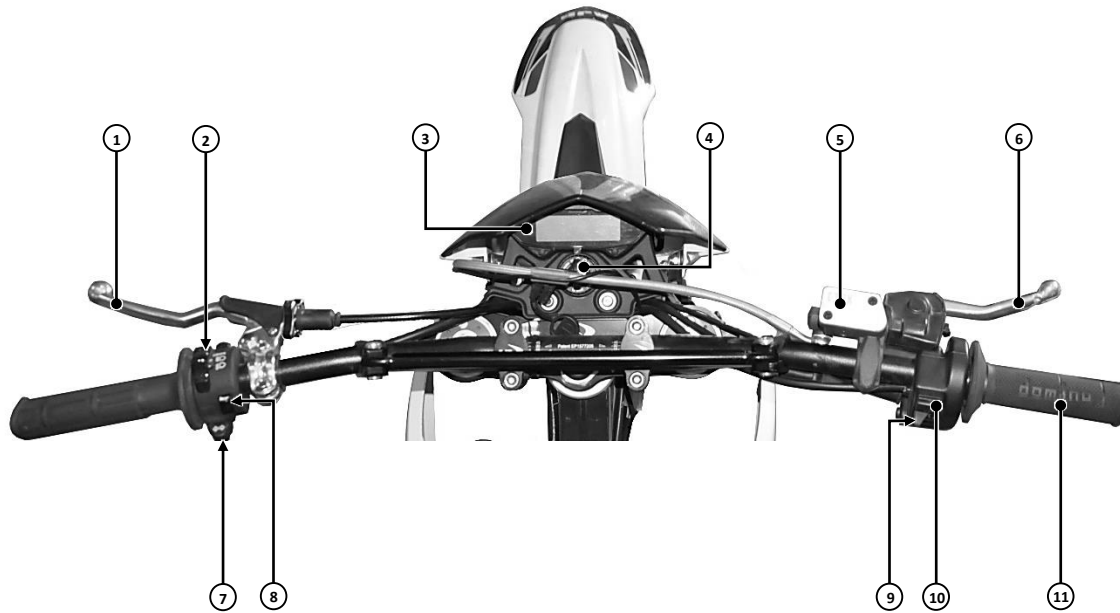

1.	Clutch lever	6.	Front brake lever	11.	Throttle grip
2.	Low/High beam switch	7.	Turn signal switch	12.	Throttle grip
3.	Instrument Panel	8.	Horn button		
4.	Ignition switch and steering lock	9.	Emergency switch		
5.	Front brake master-cylinder	10.	Electric starter button		

CONTROLS

KEYS

This motorcycle comes with a pair of keys. Be aware to keep one of the keys in safe place, at home for instance, in order to access this key in case of need in case of loss, among others.

IGNITION SWITCH AND STEERING LOCK

ON - the ignition circuit is on and the engine can be started. The key cannot be removed.

OFF - entire electrical circuits are cut-off and the engine will not start. The key can be removed.

LOCK - the engine circuits are cut off and the engine will not start. The steering lock is actuated and the handlebar cannot turn. The key can be removed.

To change to the **LOCK** position, the ignition switch must be in **OFF** position and the handlebar turned all the way to the left.

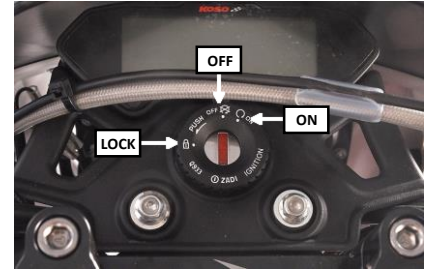





Note: Start the engine shortly after turning the key to **ON** position. Otherwise, the battery will discharge due the consumption of the instrument panel and other active electronic devices.

WARNING

Do not try to ride with the ignition switch on **LOCK** position. With the steering locked is impossible to control the motorcycle.

Do not turn the ignition key to **LOCK** position while driving.

INSTRUMENT PANEL

- 1. Left turn signal light  (Green)**
Flashes when the turn signal switch is operated to the left.
- 2. High beam indicator light  (Blue)**
Turns on when the light switch is on the high beam position.
- 3. Fuel reserve  (Amber yellow)**
The warning light turns on when the fuel level is below 3 liters.
- 4. Tachometer**
Indicates the engine revolutions per minute (rpm).
- 5. Neutral indicator light  (Green)**
Activates when the neutral gear is engaged (between 1st - 2nd gears).
- 6. Right turn signal light  (Green)**
Flashes when the turn signal switch is operated to the right.
- 7. Select button**
Swaps through the digits/settings when pressed.
- 8. Speedometer**
Indicates the instantaneous vehicle speed.
- 9. Unit system**
Presents which metric system (km/h) or imperial system (mph) units configured on the device.
- 10. Odometer/Trip meter**
Indicates the total/trip distance travelled.
- 11. Adjust button**
Changes the digits/settings when pressed.

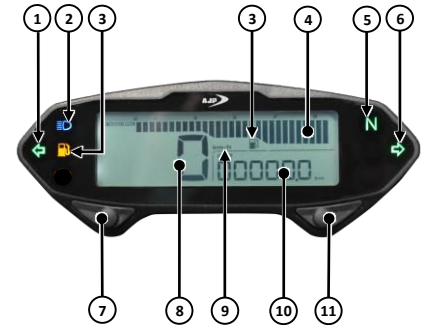

INSTRUMENT PANEL SETTINGS

Odometer/trip meter

In order to switch between total and trip function press the Adjust buttons in the main screen. Hold down the button for 3 seconds to reset the trip distance.

Home screen tachometer/fuel level gauge

Press the Adjust button in the main screen for 3 seconds to switch between the rpm gauge (tachometer) or the fuel level gauge.

Clock setting

In the main screen press simultaneously the Select and Adjust button for 3 seconds. Search for the “S4” menu using the Adjust button, press the Select button to enter the configuration mode. Press the left button to modify and the right button to move to the next digit.



Note: Press Select button continuously to return to the main screen.

WARNING

Do not change other settings in the instrument panel. Otherwise, incorrect measurements and information can be presented.

LEFT HANDLEBAR

1. Clutch lever

The clutch lever has the function of disengaging the transmission system from rear wheel, mainly used on starting the engine or shifting gears. Gripping the clutch lever (1) disengages the clutch.

2. Low/High beam switch

The low beam (D) was designed to be turned on whenever the engine runs. Simultaneously, front and rear position lights are activated. To switch to the high beam light (D) move the switch (2) to the top position, automatically the high beam indicator will activate.

3. Turn signal (blinkers) switch

- Turning the switch (3) to the left, the left turn signal is activated.
- Turning the switch (3) to the right, the right turn signal is activated.
- With the switch on center position, the turn signals will be deactivated.

When the turn signal switch is turned to the left/right position, the instrument panel turn signal light will start to flash. Place the switch at middle position to turn off the turn signals.

4. Horn button

To actuate the horn sound press the button (4).

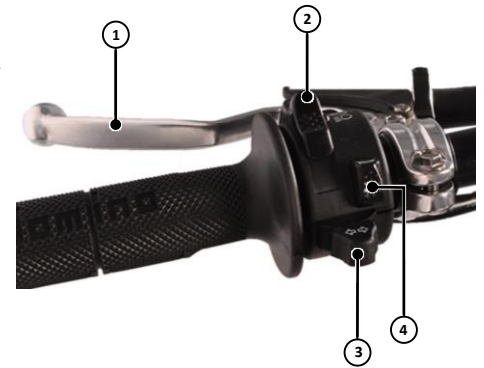

DANGER

The turn signals lights do not switch off automatically. Be aware to switch the indicator lights after turning or overtaking. Otherwise you will provide incorrect information to the others drivers.

RIGHT HANDLEBAR

1. Electric start button

Use the electric start button (1) to activate the starter motor. To start the engine, place the ignition key in the ON position and engage the neutral gear.

2. Throttle grip

The engine speed is controlled through the throttle grip (2) position. To increase the speed, rotate counter-clockwise (+). Release the grip to reduce the speed.

3. Emergency switch (kill switch)

The emergency switch (3) has two positions:

- ON position (○) enables the engine to run and all the electric system is activated.
- OFF position (⊗) stop the engine from running, cutting off the electric, except the turn signals.

To switch to the OFF position slide the switch to the right side.

4. Front brake lever

Operate the front brake by gripping brake lever (4) toward the throttle grip. Simultaneously the stop light in the taillight will light up.

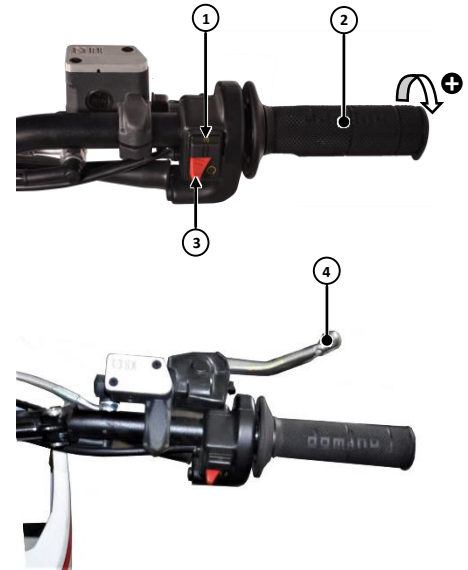

WARNING

If the Emergency switch is on the OFF position, the engine and electric starter could not be actuated. Despite instrument panel and turn signals continue to work, the horn cannot be activated.

FUEL

The AJP SPR 125 engine requires unleaded gasoline with a 95 or higher octane index (containing up to 10% of ethanol). Never use lead fuel to avoid the destruction of the catalytic converter and the exhaust system.

WARNING

Using non-recommended, adulterated or water contaminated fuel can cause severe damage on fuel pump and engine. Ensure to use only unleaded gasoline with an octane index equal or greater than indicated for this model

FUEL TANK CAP

To open the fuel tank cap (1) rotate the key counter-clockwise and remove the cap. To close, place back the cap and turn the key clockwise.

DANGER

Fuel is highly flammable and harmful to the health. Handled with caution.

Do not fill the motorcycle fuel tank near to flames or other ignition sources. Always turn off the engine before filling the tank.

Do not drop fuel over the hot areas of the motorcycle, such as engine and exhaust pipe. Clean quickly in case of spilling fuel.

In case of fuel ingestion or get in touch with eyes, search for medical treatment immediately.

Do not dispose fuel in the environment and keep out of reach from children.



Note: Check if the fuel cap do not contain dirt or water, avoiding those residuals to enter the fuel tank and consequently cause engine to stop.

GEARSHIFT PEDAL

The SPR 125 model is equipped with 5-speed transmission. On the left side of the engine is located the gearshift pedal (1). To shift gear properly:

- Actuate the clutch lever and close the throttle simultaneously to operate the gearshift pedal;
- Press down the gearshift pedal to engage a lower gear on the sequence;
- Move upwards the gearshift pedal to engage a higher gear on the sequence;
- Slowly release the clutch lever to a smooth transition.

The gearshift lever will return to original position automatically when operated.

Neutral position is located between first and second gear. To engage neutral gear, shift to first gear, with clutch lever gripped, slowly up-shift gearshift pedal until neutral indicator light up in the instrument panel.

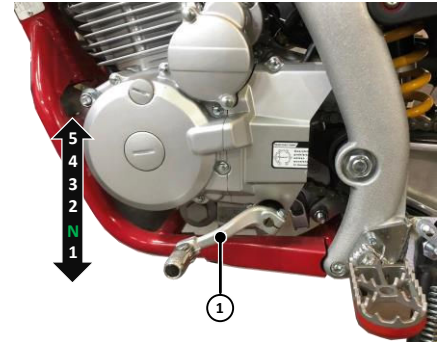

REAR BRAKE PEDAL

The rear brake pedal is placed on the engine right side. Pressing down the rear brake pedal (2) will actuate the rear brake. At the same time, the stop light in the taillight will switch on.

DANGER

A “spongy” front brake lever or rear brake pedal are indicators of a problem in the braking system. For safety reasons, do not ride the motorcycle until the braking system be checked by an AJP dealer.

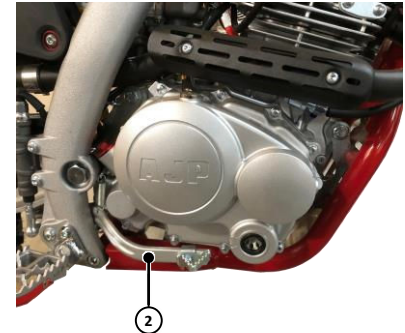

SIDE STAND

The motorcycle is equipped with a side stand on the left side. To place the motorcycle in side stand (1) push downwards using your foot until it stops. Then lean the motorcycle to the left.

Ensure that the motorcycle is placed on solid ground and in a secure position.

To raise the side stand, hold the motorcycle in upright position, the side stand should fold automatically. Otherwise, verify and lubricate the fixation area.

DANGER

Always inspect if side stand is raised up before each ride. The side stand can drag on the ground while driving and cause control loss of the motorcycle.

WARNING

The side stand was designed only for the motorcycle weight. If there is additional load, the side stand or frame can be damaged and the motorcycle may fall over.

Park on solid and leveled ground to prevent the vehicle from falling over.

In case of parking on a sloped area, aim uphill the motorcycle front and engage first gear to reduce the chance of the side stand raising up.



Chapter C.

MAINTENANCE SCHEDULE

The maintenance schedule tables indicate the intervals between periodic services in kilometers or months. At the end of each interval, ensure to inspect, lubricate and service as instructed. If you ride the motorcycle under high stress conditions such as continuous full throttle operation or dusty climate, certain services should be performed more often to guarantee the reliability of motorcycle.

Your AJP dealer can provide you with further guidelines.

Steering components, suspension and wheel components are key items and require a special and careful service. For maximum safety, we suggest that you have these components inspected and serviced by your authorized AJP dealer.

DANGER Do not start engine in a closed area. Exhaust gases are poisonous and can cause loss of consciousness or even death. Always provide suitable ventilation while the engine is running.

DANGER Improper or absence of recommended maintenance will increase the chance of accident or motorcycle damage.
Always follow inspection, maintenance recommendations and schedules in this user's manual.

WARNING It is owner's responsibility to assure that the SPR 125 motorcycle is serviced within the periodic maintenance schedule, in an authorized dealer workshop (preferably at the dealership where the vehicle was purchased). AJP does not take responsibility for any damage if maintenance was not performed as recommended schedule, which can lead to lose the warranty.

WARNING Using poor quality replacement parts or materials can cause accelerated wear and shorten the motorcycle useful life. Use only genuine AJP spare parts.

The following table refers to the maintenance schedule that should be performed by AJP dealer to ensure correct operation.

Periodic maintenance tables (to be carried out at AJP Motos dealer)				
	After first 1000 Km	Every 3000 Km or 6 Months	Every 6000 Km or 12 Months	Every 12000 Km or 12 Months
ENGINE	Valve clearance	I/A	I/A	I/A
	Intake/exhaust rocker arm			I
	Timing chain		I	
	Timing chain guides			
	Timing gear			
	Timing chain tensioner		I	I
	Spark plug	I	I	I / R
	Spark plug cap		I	I
	Engine oil	R	R	R
	Oil strainer filter	C	C	C
	Clutch discs			I
	Carburator		C	C/I

A: Adjust

C: Clean

I: Inspect

L: Lubricate

R: Replace

CHASSIS

Periodic maintenance tables (to be carried out at AJP Motos dealer)

	After first 1000 Km	Every 500 Km or 1 Month	Every 3000 Km or 6 Month	Every 6000 Km or 12 Month	Every 12000 Km or 12 Month
Air filter (*)	I/C	I/C	I/C	I/C/R	R
Throttle cable	I		A/L	A/L	A/L
Suspension	I		I	I/L	I/L
Front fork seals	C		I	L	R
Front fork oil					R
Braking system	I		I	I	I
Braking fluid			I	I	R
Electrical system	I		I	I	I
Battery	I		I	I	I
Stop switches			I	I	I
Steering components	I/A		I/A	L	L
Drive chain	C/L	I	C/L	C/L	R
Side stand	I		I/L	I/L	I/L
Exhaust system	I		I	I	I
Wheels and tires	I		I	I	I
Tightness review (nuts, bolts, ...)	I/A		I/A	I/A	I/A

(*) Clean or replace depending the air filter condition.

A: Adjust C: Clean I: Inspect L: Lubricate R: Replace

The following table refers to the maintenance schedule that should be performed by the owner to ensure the correction operation.

Periodic maintenance table (to be carried out by the owner)					
	After first 1000 Km	Every 500 Km or 1 Month	Every 3000 Km or 6 Month	Every 6000 Km or 12 Months	Every 12000 Km or 12 Month
Air filter (*)	I/C	I/C	I/C	I/C	R
Engine oil level(*)	I	I	I (*)	I (*)	I (*)
Braking system fluid level				I	I
Brake pads			I	I	I/R
Drive chain	I	I/C/A/L	I/C/A/L	I/C/A/L	I/C/A/L
Tires condition	I		I	I/R	I/R
Wheel (rim,spokes,bearings, ...)	I		I	I	I

A: Adjust

C: Clean

I: Inspect

L: Lubricate

R: Replace

(*) Refill if necessary.

Note: Consult the Chapter D to see more information in detail.

Chapter D.

MAINTENANCE AND ADJUSTMENTS

In this chapter will be presented some procedures for the maintenance of the SPR 125 model covered in this manual. The technical information provided in this manual is a critical complement for the operator training and operators should become familiar with it. To ease understanding, diagrams and photographs are provided next to the text.

WARNING

When transporting your AJP ensure that the motorcycle is held upright with restrained straps. Be careful applying the straps to avoid damaging the front brake master cylinder or electric connections.

Use only special screws with an appropriate thread length, supplied by AJP, to fix the fuel tank. Using other screws or longer ones can cause cracks in the tank, which fuel can flow out through.

Let your motorcycle cool down before beginning any maintenance work in order to avoid get burned.

Remove methodically oil, grease, filters, fuel, cooling fluid, washing detergents, among others. To eliminate this hazardous waste without contaminating the environment, dispose the waste properly conditioned in a collection center for recycling.

Under no circumstance the used oil should be disposed in the environment, since it is highly polluting. Remember: 1 liter of used oil contaminates 1.000.000 liters of water.

LUBRIFICATION POINTS

Proper lubrication is important for smooth operating and long life of each working part of your motorcycle, as also for riding safe. It is a good practice to lubricate the motorcycle after a long rough ride or after getting in snow, water, mud or after washing it. Major lubrication points are indicated in this chapter.

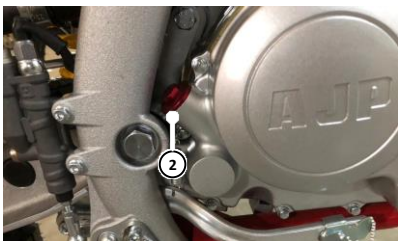
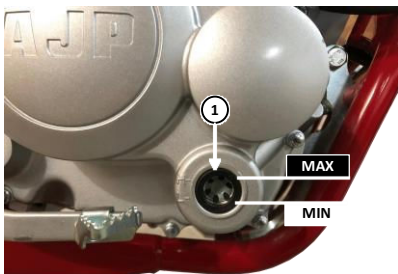

CHECKING ENGINE OIL LEVEL

On a leveled surface, place the motorcycle in an upright position. The engine oil level can be checked through the oil glass level (1).

With a warm engine, the oil level should be between the H (MAX) and L (MIN).

WARNING

Engine oil level should be checked daily or before each ride. If necessary add oil to keep the level always between higher and lower mark.

If oil level drops quickly, do not operate your motorcycle. Consult an authorized AJP dealer immediately to full check the engine.

In order to refill the engine oil:

- Remove the oil filler cap (2);
- Add new engine oil through the filler hole where the cap is located. After this procedure, place back the cap and ensure the proper tightness;
- Start the engine and let it run for a short time (1-2 minutes);
- Check the engine oil level. If necessary repeat the process until the level is close to H mark.

Recommended engine oil: ENI-AGIP i-Ride SAE 20W-50

DANGER

Insufficient engine oil or poor quality may cause severe damage to the engine. Never operate your motorcycle with low engine oil level or with non-adequate engine oil quality.

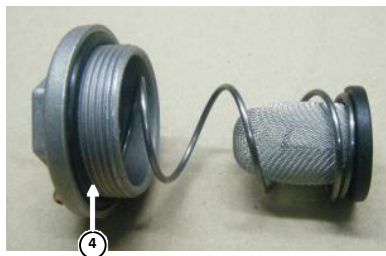
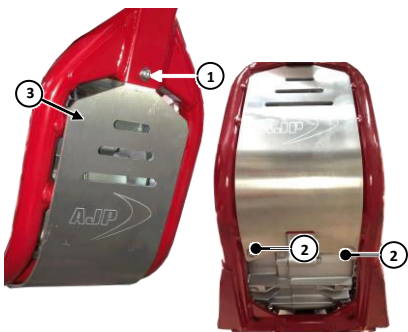

CHANGING ENGINE OIL

Engine oil must be changed with the engine warm, in operating temperature. If the engine is not warm, start the engine and let it work for 5 minutes. To change the oil, follow this procedure:

- Place the motorcycle on a horizontal surface
- Unscrew the screw (1) and (2) and remove the engine skid plate (3);
- Place an appropriate container under the engine;
- Remove oil drain plug (4) located at the lower part of crankcase;
- Drain the oil to the container avoiding spilling to the ground;
- Clean the plug (4) with solvent to remove any existent metallic particles. Dry it with compressed air;
- Clean and check if the o-rings are damaged, replace if required;
- Remove oil filler cap and fill with 1 liter of recommended engine oil;
- Start the engine and let it on idle for two minutes. Turn off the engine and wait brief moments until stabilizing oil level;
- At a level surface and with the vehicle perpendicular to the surface, check leaks and oil level, refill if necessary.

Note: if necessary, apply Teflon on plug threads to assure a perfect tightness.

Drain plug (4) torque: 15 N.m (1,5 kgf.m)

DANGER

An engine at operating temperature and engine oil it contains are very hot.
Please take all cares to avoid burning yourself.

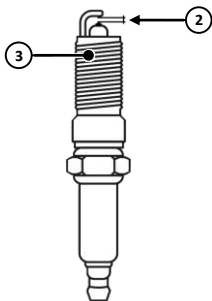
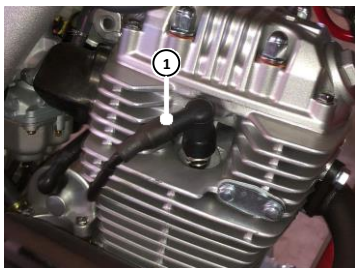

CHECKING SPARK PLUG

The spark plug is a relevant component for maximum performance and ride smoothness. Therefore, the spark plug must be kept with correct clearance between the electrodes and be periodically inspected at your official AJP Motos dealer.

To verify the spark plug, let the engine cold down to be operate safely:

- Clean the surrounding area with compressed air;
- Unplug the spark plug cap (1) and use a suitable 16 mm spark plug tool;
- Clean the spark plug with a specialized solution for the application;
- Inspect visually the spark plug (3) e verify the electrode (3) clearance with a feeler gauge. Require the replacement if necessary;
- Check the electrode color: slightly dark means good condition; too much bright means bad functioning or lean air fuel ratio; wet or with coal deposit means rich air fuel ratio.

Recommended spark plug: Standard: LG D8TC ; Equivalent: Champion A8YC ou NGK DR8ES

Electrode clearance: 0.6 - 0.7 mm

Spark Plug (3) torque: 15 N.m (1.5 kgf.m)

WARNING

Incorrect spark plug clearance or maintenance procedures can reduce the performance or cause engine malfunction.

Spark plug replacement should be only done by an AJP Motos dealer.

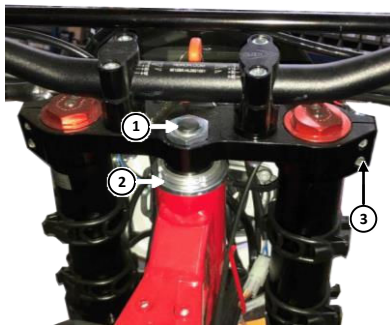

Note: The steering head bearings should not be adjusted to be tight or loose.



CHECKING AND ADJUSTING THE STEERING HEAD BEARINGS

Verify steering head bearings clearance regularly. To inspect:

- Set the motorcycle on a central stand to keep the front wheel off the ground.
- Holding the front fork bottom, try to move the fork forward and backwards;
- Loosen top nut (1) and the four screw (3) of the top triple clamp;
- Turn steering column nut (2) clockwise, with the proper tool, until there is no more play;
- With a plastic hammer, lightly tap on triple clamp to release tension;
- Tight the top nut (1) and top triple clamp screws (3) with the proper torque.
- Check the steering smooth operation by turning the handlebars.

The steering column bearings must be grease lubricated at least once a year. For the purpose, it's recommended to apply "Marine/Heavy-duty" grease.

CLEANING FRONT FORK DUST SEALS

The dust protection seal (4) has two functionalities: prevent the dirt going inside the suspension system and remove the dirt of the front fork in compression solicitations. However, after some time, dirt may get and accumulate behind this seals. If dirt is not removed, oil retention seals can be damaged and start leaking.

- Use a screwdriver gently to remove the dust seals (4) without damaging the fork tube;
- Move the seals downwards along the tube;
- Clean the dust seals and front fork tubes thoroughly;
- Lubricate this components with silicone spray or engine oil;
- Push the front fork dust seals back to the original position manually.



ADJUSTING FRONT FORK SUSPENSION

To adjust rebound of the suspension system:

- Turn the screw (1) clockwise in order to decrease the rebound speed.
- Turn the screw (1) counter-clockwise increase the rebound speed.

Standard settings - Enduro and Supermoto: 10 clicks from the fully closed position.

To adjust compression of suspension system :

- Turn the screw (2) clockwise to a harder response.
- Turn the screw (2) counter-clockwise to a softer response.

Standard settings - Enduro and Supermoto: 7 clicks from the fully closed position.

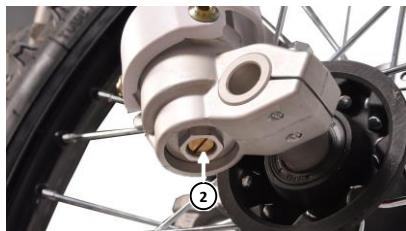

Note: Turn clockwise (+) the screws (1) and (2) to place in fully closed position, without additional effort to prevent damaging the internal parts.

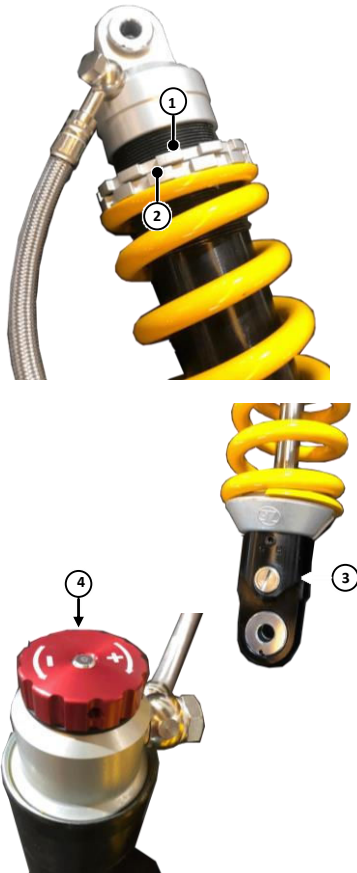

ADJUSTING REAR SUSPENSION

The AJP SPR 125 model is equipped with a fully adjustable shock absorber.

To adjust the preload:

- Loose the upper nut (1);
- Turn the adjusting nut (2) clockwise for more preload.
- Turn the adjusting nut (2) counter-clockwise for less preload.

In order to adjust the rebound:

- Rotate screw (3) clockwise to decrease the rebound speed.
- Rotate screw (3) counter-clockwise to increase rebound speed.

To adjust low or fast compression damping, rotate the adjuster (4) respectively.

- To decrease the compression speed, turn counter-clockwise.
- To increase the compression speed, turn clockwise.

DANGER

Improper servicing of the rear shocks absorber is dangerous. The rear shock contains high-pressure gas and can explode when handled improperly.

Standard settings:

Damping Force: Turn 20 clicks counter-clockwise (-) from the closed position.

Rebound: Turn 10 clicks counter-clockwise (-) from the closed position.

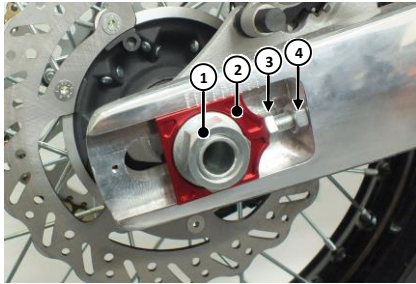

ADJUSTING DRIVE CHAIN

The drive chain clearance must be between the 15 to 30 mm interval, at the half way between the drive sprocket and rear sprocket.

To adjust the tightness, place the motorcycle on the side stand.

- Loosen the axle nut (1);
- Loosen the fixing nuts (4) on the both sides;
- Adjust the adjuster screws (3) until the clearance of drive chain is within specifications. Simultaneous, ensure that the rear sprocket is aligned with drive sprocket;
- Check if both chain tensioners of rear wheel (2) are aligned with the reference marks on swing arm. If they are not visible, measure the distance between tensioners and swing arm end;
- Tight securely the axle nut (1) and afterwards the fixing nuts (4);
- Verify the chain clearance after the procedure;
- Lubricate and adjust if necessary.

DANGER

Excessive tension of the drive chain will produce additional load on the components. Aside from resulting on premature wear, the drive chain may break.

Excessive drive chain clearance can result in chain jumping off from the chain sprockets. In this case, the chain can also block the rear wheel or damage the engine.

In both cases, the rider can lose control of the motorcycle.

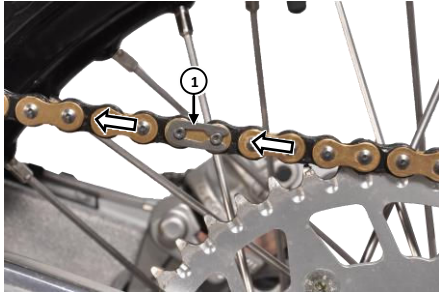

DRIVE CHAIN MAINTENANCE

A good maintenance is extremely important for long chain life. Chains without o-rings should be cleaned in fireproof solvent regularly and afterwards treated with hot grease or chain spray. On the other hand, o-ring chains are simple to clean. The best way is to use lots of water but never use brushes or cleaning liquids. After letting dry completely, use a chain spray to lubricate it.

Verify also the wearing status of the engine sprocket, rear wheel sprocket, swingarm protection and drive chain guide, replacing if necessary. It's highly recommended to proceed with the full replacement of the drive chain kit (engine sprocket, rear wheel sprocket and drive chain).

For safety reasons, certify the chain master link clip (1) is mounted always with the closed side towards the chain/wheel rotation direction.

DANGER

Never let grease or lubricant reach rear tire or brake disc. Otherwise, road adherence and the braking effects will be strongly reduced, which can cause control loss.

WARNING

During the assembly of the chain master link clip (1), assure that the closed side of the master link is pointing on running direction.



TIRES CONDITION

Tire model, condition and air pressure affect the motorcycle behavior. Therefore, tires must be checked before riding.

- Tire size can be found in the technical specifications and registration documents.
- Before riding, inspect the tires for punctures, nails or other sharp objects that might have stuck.
- Be aware of specific regulations in your country for minimum tire tread requirements.

DANGER

Replace damaged tires immediately. Worn tires could have negative effect on the motorcycle performance, especially on wet surfaces.



Note: The correct tire pressure depends on the road/terrain surface type.

TIRES PRESSURE

Tires pressure should be checked regularly with “cold” tire. Proper pressure ensures optimum driving comfort and extends the tire life.

The pressure values (see CHAPTER 3) are indicated for road use. For an off-road use, it's recommended a lower pressure to assure traction. In these conditions, it's recommended 1.5 bar (21 psi) in both tires.

WARNING

Tires air pressure with too low/high values cause abnormal wear and overheating. Correct the pressure every ride.



CHECKING SPOKES TENSION

Correct spokes tension is extremely important for a riding safety. Loose spokes induce unbalanced areas on wheel, letting other spokes to become loose.

Check spokes tension, especially on a new motorcycle, in regular intervals.

To inspect use a screwdriver to slightly sweep the spokes. Spokes with same dimensions should have the same sound. If necessary, have the spokes retightened and wheel correction by an AJP dealer.

DANGER

Spokes can break apart under extreme solicitations or by riding with incorrect tension. This may lead to an unstable behavior of the motorcycle.

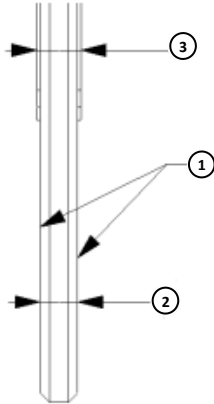

BRAKE DISCS

Due to wear, the thickness of brake discs in the contact area (1) of the brake pads starts to decrease. At their thinnest point (2), the brake discs shall not be less than **0.50 mm** thinner than nominal thickness. Measure the nominal thickness in the zone (3) outside of contact area and check for wear in several points.

DANGER

For your own safety replace the brake discs as soon as they reach wear limit (3 mm thickness).

Any repair on brake system should be performed by an authorized AJP dealer.



BRAKE PADS

The semi-metallic brake pads used on the SPR 125 front and rear brake systems provide an optimal combination of brake power, performance and lifecycle.



CHECKING FRONT BRAKE PADS

The front brake pads (1) can be inspected through the spokes on the opposite side of the brake system, as illustrated. The linings must have at least 1 mm thickness.

DANGER

At their most worn point, brake pad linings should not be thinner than 1 mm, otherwise can lead to braking failure.



CHECKING REAR BRAKE PADS

The rear brake pads (2) can be inspected from the rear side of the motorcycle. The linings cannot have less than 1 mm thickness.

DANGER

If brake pads are replaced too late, steel components of brake pad will rub against brake disc. Thereby, braking effect will be reduced and destroying the brake disc.



FRONT BRAKE MASTER CYLINDER

The front brake master cylinder have been designed in such a way that even if the brake pads are worn, it is not necessary refill the reservoir. If brake fluid level drops below the minimum level either there is a leak or the brake pads are completely worn.

In this case, consult an authorized AJP dealer immediately.

DANGER

Change brake fluid at least once each two years. If you wash your motorcycle often or wet environments, brake fluid should be changed even more often (once a year), since the brake fluid tends to absorb water.

Vapor pockets can form on “old” brake fluids, even at low temperatures, causing brake system to fail.

CHECKING FRONT BRAKE FLUID LEVEL

Brake fluid reservoir is linked with the front brake master cylinder in the handlebar and equipped with a level inspection glass (1). With the reservoir horizontally leveled, the brake fluid level should not drop below the middle of the level glass.

DANGER

Brake fluid can cause skin irritation. Avoid contact with skin and eyes. If you get brake fluid in your eyes, clear with plenty of water and look for medical assistance.

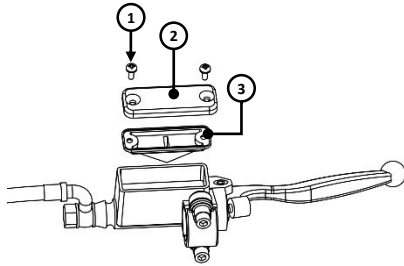

REFILLING FRONT BRAKE FLUID

- Remove the screws (1);
- Remove the reservoir cover (2) and the diaphragm (3);
- Place front brake reservoir in a horizontal position and fill up the reservoir until the **MIN** mark with clean brake fluid **DOT 4**;
- Replace diaphragm, cover and screws if damaged;
- Clean the spilled or overflowed brake fluid with water.

WARNING

Do not let brake fluid get in contact with paint. Brake fluid is highly corrosive and may damage painted parts of the vehicle.

Use only clean brake fluid from a sealed or hermetic closed container.

Avoid actuate brake lever with cover removed. Brake fluid will spill over if lever is actuated.

CHECKING REAR BRAKE FLUID LEVEL

The rear brake reservoir is integrated in brake master cylinder and is located on the right side of the motorcycle, near of the swing arm.

Verify the brake fluid level in the level glass (4).



WARNING

The oil level must be above the **MIN** mark when the motorcycle is in the upright position.

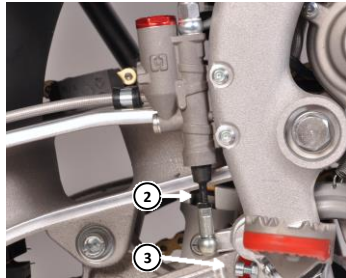
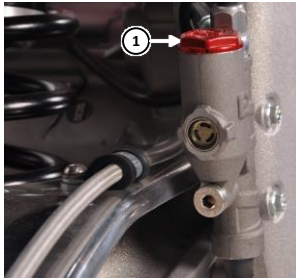

REFILLING REAR BRAKE FLUID

- Remove the master cylinder cover with diaphragm (1);
- Place rear brake master in a horizontal position and fill up the reservoir until the **MIN** mark with clean brake fluid **DOT 4**;
- Replace diaphragm and reservoir cover if damaged;
- Clean the spilled or overflowed brake fluid with water.

WARNING

Do not let brake fluid get in contact with paint. Brake fluid is highly corrosive and may damage painted parts of the vehicle.

CHANGING REAR BRAKE PEDAL POSITION

The rear brake pedal position can be modified rotating the bolt (3).

Adjust the piston rod (2) to control the brake pedal free play. The rear brake pedal must have 1 to 2 mm of free play.

DANGER

If there is no brake pedal free play, the pressure can build up in brake system while driving and block the rear wheel. Brake system can overheat and even completely fail in extreme cases.

Do not press continuously the rear brake pedal while riding.



REMOVING THE BATTERY

The battery (1) has a closed system and therefore requires no maintenance (MF). Keep the battery poles clean and put slightly acid free grease if necessary.

To remove the battery:

- Remove the side panels screws and remove it;
- Disconnect firstly the negative pole (-) and then the positive pole (+) of the battery;
- Unhitch the rubber band (2);

On assembly, first connect the red wires in positive pole and then the black wires in negative pole.

In the event of motorcycle storage for a long period, remove the battery and recharge it every 3 months (see STORAGE PROCEDURES). Keep storage in a dry place and within temperature range between 10-35°C. Do not let the battery exposed to direct sun radiation.

DANGER

Battery is a closed model (MF) but can nevertheless emit explosive gases. Avoid sparks and fire near the battery.

WARNING

Never reverse polarity or disconnect the battery while the engine is running, otherwise the battery, voltage regulator-rectifier or other electric components will be damaged.

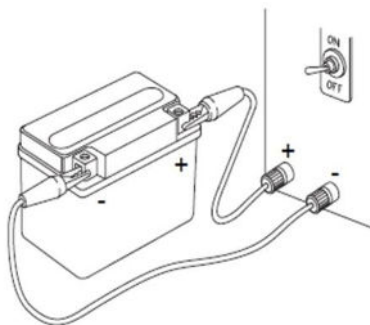

Note: The battery must be recharged with a proper automatic battery charger. The charger should turn off when the battery voltage is 14.4 V.

RECHARGING THE BATTERY

Motorcycles stored for long periods or equipped with additional electronic accessories will cause battery discharge.

The battery should be charged when identified issues as instrument panel malfunction or electronic starter motor malfunction.

In case of home battery recharge:

- Remove the battery (see REMOVING THE BATTERY);
- Place the battery in a clean, dry and ventilated area. Keep out of ignition sources or inflammable substances;
- Inspect the battery charger. Ensure that it is in good conditions and set with right values;
- Connect first the terminal clamps in the battery. Then plug the charger to a 110 VAC-220 VAC electric network;
- Check the voltage. The battery voltage should be in 13.9 V to 14.4 V range;

WARNING

Do not let the battery voltage drop below 13.1 V. Improper voltage can lead to problematic starts or performance loss.

Use a recommended charger. Incorrect charger configurations can damage or destroy the battery.



FUSES

The fuse are disposed underneath the seat. Having removed the seat you will be able to see the fuse.

The fuse capacity is 20 Ampere.

Always carry an extra fuse in the fuse holder with you whenever you are riding the motorcycle.

Replace a blown fuse only with an equivalent one. If a new fuse recently installed gets blown, we recommend that your motorcycle be inspected by an AJP dealer.

Plastic covers should always be correctly placed in their correspondent support in order to avoid any fuse to be lost.

WARNING

Under none circumstances allow the installation of a stronger fuse or repair a damaged one. An inexpert treatment could damage the entire electrical installation.

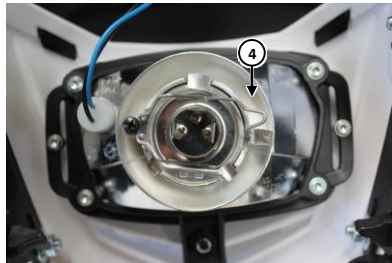
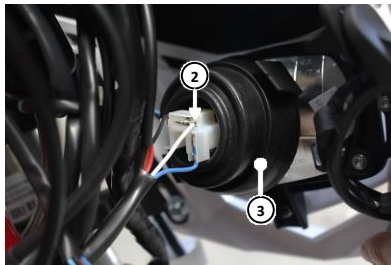
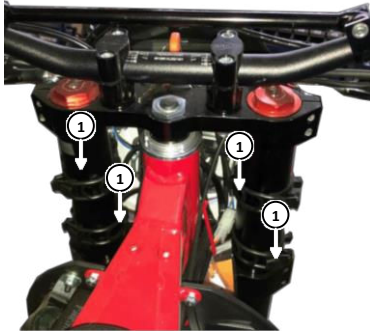

REPLACING HEADLIGHT LAMP

To replace the headlight bulbs ensure that the ignition key is in the OFF or LOCK position.

- Release the rubber clamps (1) on the left and right side of the headlight assembly;
- Detach the connector (2) from the lamp and remove the rubber protection (3);
- Press the retaining clip/spring end (4) to release it;
- Remove the lamp holding it by the terminals.
- Install the new lamp. Avoid touching the light bulb, otherwise it can compromise the lamp lifespan;
- Revert the process to assemble the headlight;
- Check headlight beam alignment, adjust if necessary.

To change the position light bulb:

- Release the rubber clamps (1) on the left and right side of the headlight assembly;
- Pull out the position light support to access to the bulb;
- Remove the bulb and place a new one with the same specifications;
- Clean the bulb glass before surface;
- Revert the process to assemble the headlight;
- Check headlight beam alignment, adjust if necessary.

WARNING

Never replace the H4 HS1 headlamp bulb with another model or with a different power than those specified for the SPR 125 model.

Do not touch the lamp glass with your fingers, otherwise grease stains can cause hot spots and shortened life. In this case, clean the glass globe with alcohol and let it dry.



REPLACING TAILLIGHT (1)

The taillight (1) is composed by a set of LEDs and does not allow replacing them. In case of presence or stop light failure, the taillight must be replaced.



REPLACING LED TURN SIGNALS (2)

The LED turn signals (2) on the AJP SPR 125 are not repairable. Replacement of turn signals should only be performed by an authorized AJP dealer.

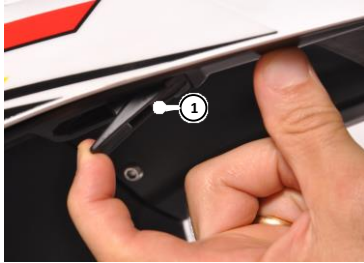

CLEANING AIR FILTER

Dirty air filters cause restriction of air flow, reducing engine performance and increasing fuel consumption. Therefore, it is highly recommendable to clean the air filter regularly.

To access the air filter:

- Rotate the lock system tab (1) under the seat and remove the seat from the motorcycle;
- Remove the air filter's cover by unscrewing the fixation screw (2);
- Remove the metallic support inside the air filter foam element;
- Thoroughly wash the air-filter in special cleaning fluid, squeeze it and dry it with compressed air;
- Install the metallic support inside the air filter foam;
- Oil the dry air filter with high-grade filter oil and clean the air filter box;
- Clean the air filter's contact surface (3);
- Mount the filter together with the filter bracket and fix them with the rubber washer and the screw;

WARNING

Do not clean the air filter with fuel or solvents that can damage the cotton.

Maintain the air filter clean and lubricated (do not over apply, only oil wet) to assure effective protection to the engine.

Never start your motorcycle without an air filter. Otherwise, dust or dirt may penetrate the engine, causing or severely wearing the engine components.



CHECKING EXHAUST SYSTEM

The exhaust system (1) requires regular inspection, especially when frequently exposed to severe motorcycle riding conditions. Ensure that all exhaust components are in perfect working condition and that there are no leaks.

Regularly check the exhaust muffler alignment/fixation ensuring that it does not touch the swingarm under full suspension compression.

In the event of a fall, head to your AJP dealer to inspect the exhaust muffler support. If damaged it is necessary your replacement and/or adjust the muffler position on the fixing clamp to maintain the correct alignment.

DANGER

Exhaust system can reach high temperature in operation. Be careful handling the motorcycle even after parking in order to avoid burns.

Wear suitable clothes and boots to protect you from the high temperatures of the exhaust system.

Park the motorcycle in clear area, keep out of reach inflammable substances and children.

Chapter E.

TECHNICAL SPECIFICATIONS

ENGINE

Type	Single cylinder, 4 strokes
Displacement	124 cc
Bore	56.5 mm
Stroke	49.5 mm
Cooling	Air
Compression ratio	9.2:1
Start	Electric
Fuel	Unleaded fuel 95
Fuel consumption	1,8 L/100 Km
CO ₂ emission	41 g/Km

TIMING SYSTEM

Type	2 valves, single overhead camshaft (SOHC)
Valve clearance (cold engine)	
Intake	0.05 mm
Exhaust	0.08 mm

LUBRICATION

Type	Wet sump with dual oil pump, metallic oil filter
------	--

IGNITION

CDI	
Spark plug type	LG D8TC (Champion A8YC ou NGK DR8ES)
Spark plug electrode gap	0,6 - 0,7 mm

FUEL SYSTEM

Type	Carburator Ø30 mm
------	-------------------

CLUTCH

Type	Oil bath multiple disc clutch, cable control
------	--

TRANSMISSION

Type	Constant mesh gear type
Total of gears	5
Primary ratio	3,333 (Z70/Z21)
1 st gear ratio	2,769 (Z36/Z13)
2 nd gear ratio	1,882 (Z32/Z17)
3 rd gear ratio	1,400 (Z28/Z20)
4 th gear ratio	1,130 (Z26/Z23)
5 th gear ratio	0,960 (Z24/Z25)
Final ratio	3,000 (Z48/Z16)

CHASSIS

Type	Double cast aluminium beam + steel sub-frame + structural fuel tank
------	---

FRONT SUSPENSION

Type	<i>Enduro e Supermoto:</i> Upside down fork AJP
------	---

Diameter	<i>Enduro e Supermoto:</i> Ø 43 mm
----------	------------------------------------

Stroke	<i>Enduro e Supermoto:</i> 280 mm
--------	-----------------------------------

REAR SUSPENSION

Type	AJP progressive linkage system, fully adjustable ZF SACHS Piggyback shock
------	---

Stroke	300 mm - Fully adjustable
--------	---------------------------

FRONT BRAKE

Type	<i>Enduro e Supermoto:</i> Double piston Braktec caliper
------	--

Brake disc diameter	Ø 260 mm
---------------------	----------

REAR BRAKE

Type	<i>Enduro e Supermoto:</i> Single piston floating Braktec Caliper
------	---

Brake disc diameter	<i>Enduro e Supermoto:</i> Ø 220 mm
---------------------	-------------------------------------

FRONT WHEEL

Rim size	21"x1.60	17"x2.50
----------	----------	----------

Tires	Michelin Enduro Medium	Michelin Pilot Street
-------	------------------------	-----------------------

Tires size	<i>Enduro:</i> 90/90 21"	<i>Supermoto:</i> 100/80 17"
------------	--------------------------	------------------------------

Pressure (road with maximum load)	2.3 bar
-----------------------------------	---------

REAR WHEEL

Rim size	18"x2.15	17"x3.50
----------	----------	----------

Tires	Michelin Enduro Medium	Michelin Pilot Street
-------	------------------------	-----------------------

Tires size	<i>Enduro:</i> 120/90 18"	<i>Supermoto:</i> 130/70 17"
------------	---------------------------	------------------------------

Pressure (road with maximum load)	2.3 bar
-----------------------------------	---------

CAPACITY

Fuel tank capacity	9.5 L
--------------------	-------

Fuel reserve	1 L
--------------	-----

Engine oil filter replacement	1 L
-------------------------------	-----

LUBRICANT TABLE, SUPPLIERS

Engine and gearbox lubricant	ENI i-Ride MOTO 20W-50
Air filter lubricant	GREEN FILTER - AIR FILTER CLEANER
Brake fluid	ENI DOT 4 SAE J 1704
Lubricant grease	ENI AGIP GR MU EP 2
Drive chain lubricant	AGIP CHAIN GREASE SPRAY
Suspension oil	
Front	<i>Enduro e Supermoto: 5W</i>
Rear	ENI i-Care CONTACT CLEANER
Electric contact protection	ENI i-Ride MOTO 20W-50

OVERALL DIMMENSIONS

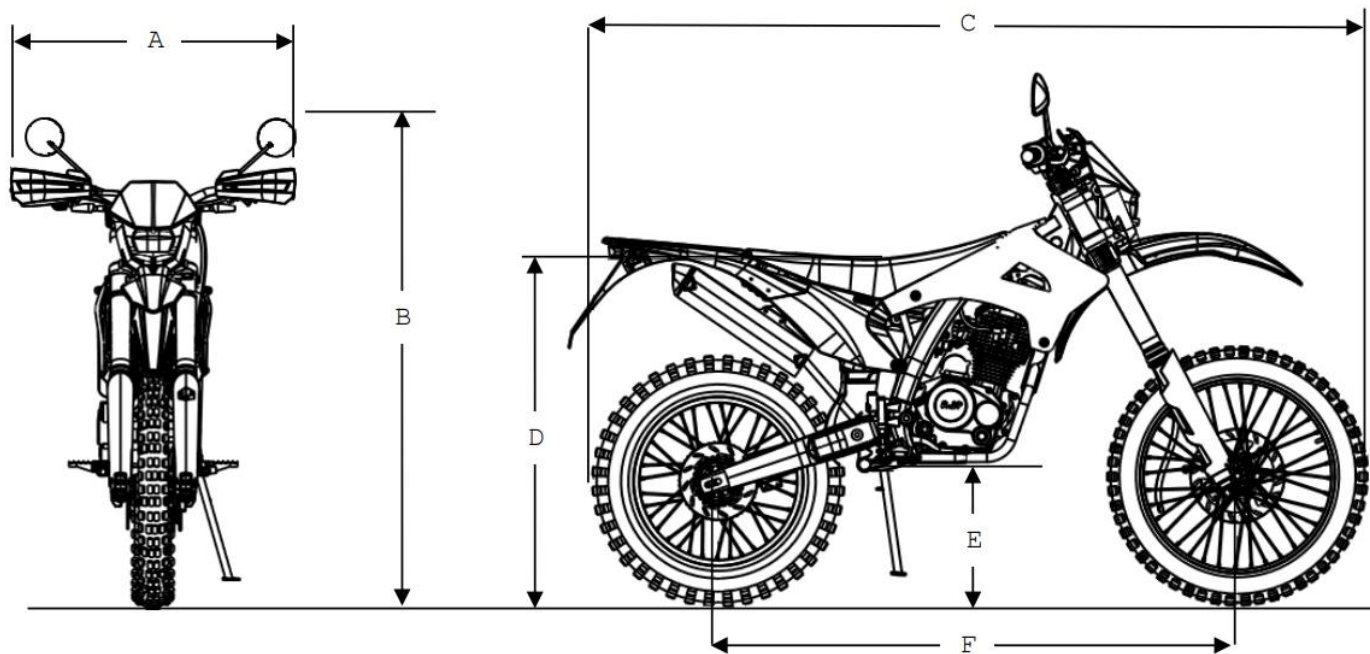

OVERALL DIMENSIONS

POSITION	DIMENSIONS (mm)	
	<i>ENDURO</i>	<i>SUPERMOTO</i>
A	810	
B	1280	1280
C	2100	2100
D	930	930
E	350	350
F	1360	

HARNESS DIAGRAMS - ELECTRIC HARNESS

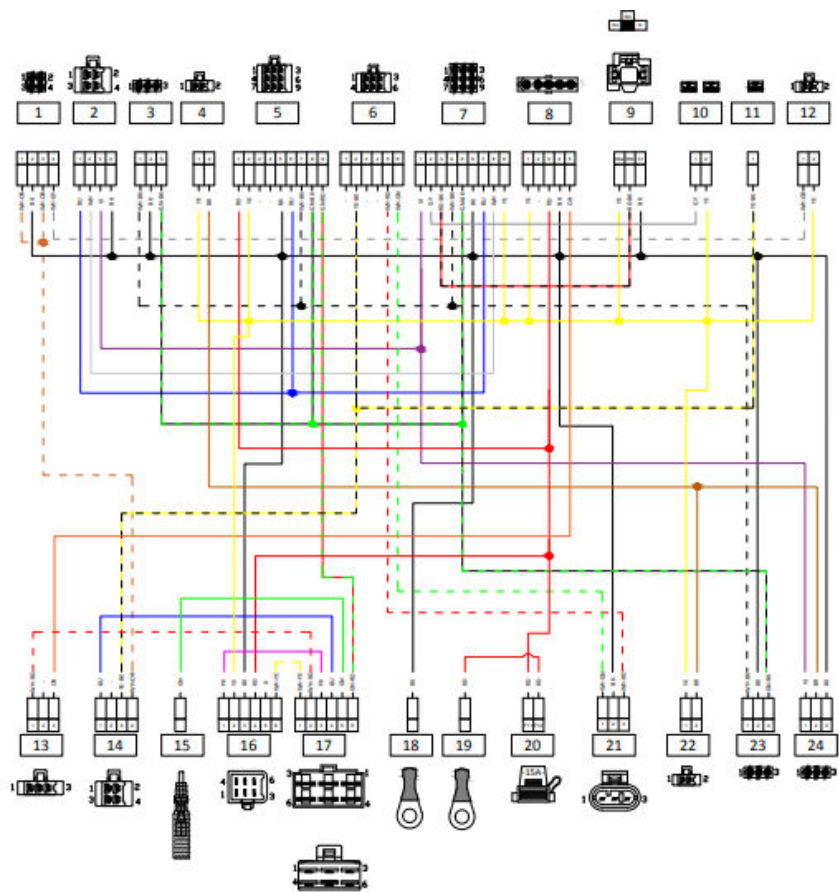

HARNESS DIAGRAM - DESCRIPTION

REF.	CABLAGEM ELETRICA	REF.	COR
1	POWER CUT STARTER BUTTON	YE	YELLOW
2	FRONT LIGHTS	RD	RED
3	FRONT BLINKER	BK	BLACK
4	FRONT STOP	BU	BLUE
5	MANOMETER C/KM	BR	BROWN
6	MANOMETER C/KM	GN	GREEN
7	COMMUTADOR LIGHTS	VI	VIOLET
8	IGNITION KEY	WH	WHITE
9	BLINKER RELAY	GY	GREY
10	CLAXON	PK	PINK
11	IGNITION COIL	OR	ORANGE
12	STARTER RELAY		
13	CDI		
14	CDI		
15	CDI		
16	VOLTAGE REGULATOR		
17	GENERATOR		
18	BATTERY -		
19	BATTERY +		
20	FUSE BOXES		
21	FUEL LEVEL SENSOR		
22	REAR STOP LIGHT		
23	REAR BLINKER		
24	REAR LIGHT		



www.ajpmotos.com

Rua de Santana, 91 info@ajpmotos.com
4620-510 Pias, Louzada - PORTUGAL Tel: +351 255 815 122